

ICC-ES Evaluation Report

ESR-1709

Reissued December 2023

Subject to renewal December 2024

ICC-ES Evaluation Reports are not to be construed as representing aesthetics or any other attributes not specifically addressed, nor are they to be construed as an endorsement of the subject of the report or a recommendation for its use. There is no warranty by ICC Evaluation Service, LLC, express or implied, as to any finding or other matter in this report, or as to any product covered by the report.

Copyright © 2023 ICC Evaluation Service, LLC. All rights reserved.

<p>DIVISION: 07 00 00— THERMAL AND MOISTURE PROTECTION</p> <p>Section: 07 32 03—Roof Tile Adhesive</p>	<p>REPORT HOLDER:</p> <p>ICP CONSTRUCTION INC. DBA ICP BUILDING SOLUTIONS GROUP</p>	<p>EVALUATION SUBJECT:</p> <p>ICP ADHESIVES POLYSET® AH-160</p>	
--	---	---	---

1.0 EVALUATION SCOPE

Compliance with the following codes:

- 2021, 2018, 2015, 2012, 2009 and 2006 [International Building Code® \(IBC\)](#)
- 2021, 2018, 2015, 2012, 2009 and 2006 [International Residential Code \(IRC\)](#)
- 2013 *Abu Dhabi International Building Code (ADIBC)*[†]

[†]The ADIBC is based on the 2009 IBC. 2009 IBC code sections referenced in this report are the same sections in the ADIBC.

Properties evaluated:

- Physical properties
- Wind resistance
- Roof classification

2.0 USES

ICP Adhesives Polyset® AH-160 is an expanding adhesive used to adhere clay and concrete roof tiles to underlayments installed over solid sheathing. ICP Adhesives Polyset® AH-160 is used to attach hip and ridge tiles and can be used to seal the junction between hip and ridge frames and field tiles.

3.0 DESCRIPTION

Materials:

3.1 ICP Adhesives Polyset® AH-160:

ICP Adhesives Polyset® AH-160 is a two-component expanding polyurethane foam plastic that is mixed and dispensed from a dispensing system provided by ICP Construction Inc. dba ICP Building Solutions. The components are available in refillable tanks ranging in size from 17 to 350 gallons (64.3 to 1325 L). The materials have a shelf life of 12 months when stored in unopened containers. Once the tank valves are opened, the chemicals must be used within 90 days. Refillable cylinders must be stored in an area where the temperature is kept between 45° and 95°F (7.2° and 35°C). The product temperature prior to application should be between 70°F and 90°F (21.1° and 32.2°C). The minimum ambient temperature is 45°F (7.2°C) and surface temperature must be 55°F (12.8°C) and rising.

The components are also available in disposable cylinders called AH-160 PROPACK® in 26.5-pound (11.9 kg) (AH-160 PROPACK® 30's) or 85.7-pound (38.6 kg) (AH-160 PROPACK® 100's) cylinders when the AH-160 PROPACK® dispensing system is used. Once the cylinder valves are opened, the chemicals must be

used within 30 days. AH160 PROPACK® kits must be stored in an area where the temperature of the chemical is kept between 45° and 95°F (7.2° and 35°C). The product temperature prior to application should be between 70°F and 90°F (21.1° and 32.2°C). The minimum ambient temperature is 45°F (7.2°C) and surface temperature must be 55°F (12.8°C) and rising.

The foam plastic adhesive, when applied in such a fashion as to be representative of actual installation conditions, has a flame-spread rating of 75 or less when tested in accordance with ASTM E84.

3.2 Roof Deck:

Roof decks must be plywood bonded with exterior glue or OSB having a $32/16$ span rating, and must comply with U.S. DOC PS-1 or PS-2, respectively. Minimum sheathing thicknesses are specified in [Tables 1, 2](#) and [3](#).

3.3 Underlayment:

Underlayment must be as described in [Table 1, 2](#) or [3](#) and Section 4.1.2 and 4.2.1 of this report, and must comply with the applicable code.

3.4 Hip and Ridge Channels:

Hip and ridge channels, when used, are East Coast Metals, Inc. Trim Lock or Trim Lock Plus pre-formed metal channels. They are formed from ASTM B209, 3003-H14 aluminum alloy with a minimum thickness of 0.030 inch (0.8 mm), ASTM A653 G90 galvanized steel with a minimum thickness of 0.019 inch (0.5 mm) or ASTM A792 AZ50 galvalume steel with a minimum thickness of 0.019 inch (0.5 mm). They are available in heights of 3, 3.5, 4, 5 or 6 inches (76, 89, 102, 127 or 152 mm) and have 1.5 inch (38 mm) deck-flanges. See [Figure 5](#).

3.5 Roof Tile:

Roof tiles must be regular-weight or lightweight clay or concrete tiles, and must be recognized in a current ICC-ES evaluation report that specifically recognizes use of roof tile adhesive. Regardless of shape, tiles must conform to the requirements specified in items 4, 5, 6 and 7 of IBC Section 1609.5.3 Tiles may also be conventional barrel-shaped tiles having a minimum rise-to-width ratio of 1:4. The tiles must have a maximum tile factor of 1.407 ft³. The tile factor is defined as $TF = 0.76 L2b$, where L is the tile length in feet and b is the tile width in feet (for SI: $TF = 12 454 L2b$, where L and b are in mm). For purposes of this report, flat- and low-profile tiles have a rise equal to or less than $1/2$ inch (12.7 mm), and a rise-to-width ratio of less than or equal to 1:5; medium-profile tiles have a rise greater than $1/2$ inch (12.7 mm) and a rise-to-width ratio less than or equal to 1:5; high-profile tiles have a rise to width ratio greater than 1:5.

4.0 DESIGN AND INSTALLATION

4.1 Design:

4.1.1 Wind Resistance: Allowable wind resistance for underlayment fastening patterns and various methods of roof tile adhesive application are noted in [Tables 1](#) through [4](#) and [Figures 1](#) through [3](#) of this report.

4.1.2 Underlayment: The required design pressure for the building is the component and cladding wind load determined in accordance with Section 1609 of the IBC. The fastener spacing for the selected underlayment (single-ply, single-ply with battens, or two-ply) is then determined from [Table 1, 2](#) or [3](#), of this report as applicable. Two-ply system is considered in this application as an anchor sheet mechanically attached to the substrate and a cap sheet adhered to the anchor sheet with hot- or cold-applied asphaltic adhesive. The allowable uplift resistance determined from [Table 1, 2](#) or [3](#) must be equal to or greater than the required design pressure determined in accordance with Section 1609.5.3 of IBC.

4.1.3 Tile: The required aerodynamic uplift moment, M_a , for the tiles must be determined from Equation 16-18 in 2021 IBC Section 1609.5.3, Equation 16-34 in 2018, 2015 and 2012 IBC Section 1609.5.3, Equation 16-33 in 2009 IBC Section 1609.5.3, or Equation 16-35 in 2006 IBC Section 1609.5.3. The allowable aerodynamic uplift moment for each type of adhesive application (two paddy, medium paddy or large paddy) is indicated in [Table 4A](#) or [Table 4B](#) of this report. The allowable uplift moment determined from [Table 4A](#) or [Table 4B](#) must be equal to or greater than the required aerodynamic uplift moment.

4.2 Installation:

4.2.1 Underlayment: Underlayment installation must be as described in Section 4.2.1.1 or 4.2.1.2.

4.2.1.1 Single-ply Underlayment: Single-ply underlayments are limited to roof slopes between 4:12 and 6:12 (18° and 26°). The underlayment consists of a single layer of 90-pound, mineral-surfaced roll roofing complying with ASTM D6380. The underlayment is applied horizontally along the roof line and is mechanically fastened to the roof deck with 0.120 inch (3 mm [No. 11 gage]), ring shank, corrosion-resistant roofing nails with $15/8$ -inch-diameter (41.3 mm) tin caps, spaced in accordance with the fastening requirements of [Table 1](#) or [Table 2](#). Nails must be of sufficient length to penetrate the deck a minimum of $3/4$ inch (19.1 mm) or through the thickness of the sheathing, whichever is less. The underlayment must be installed with a weave pattern at all valleys. The underlayment must extend 4 inches (102 mm) up vertical surfaces.

4.2.1.2 Hot Mop 30/90 (Two-Ply) Underlayment System: The 30/90 underlayment may be used on all roof slopes between 2¹/₂:12 and 12:12 (12° and 45°). A base ply consisting of ASTM D226, Type II, asphalt-saturated felt is applied over the roof deck with 2-inch (51 mm) head laps and 6-inch (152 mm) end laps, and is attached to the deck using 0.120 inch (3 mm [No. 11 gage]), ring shank, corrosion-resistant roofing nails and 1⁵/₈-inch-diameter (41.3) tin caps spaced in accordance with the fastening requirements in [Table 3](#) of this report. Nails must be of sufficient length to penetrate the deck a minimum of ³/₄ inch (19.1 mm) or through the thickness of the sheathing, whichever is less. The underlayment must be installed with a weave pattern at all valleys. The base ply must extend 4 inches (102 mm) up vertical surfaces.

The top ply consists of one layer of 90-pound, mineral-surfaced, asphalt roll roofing complying with ASTM D6380. The top ply is applied over the base ply with a full mopping of ASTM D312, Type III or IV, asphalt applied at a minimum rate of 25 pounds per 100 square feet (1.21 kg/m²). Headlaps and endlaps in the top ply must be a minimum of 3 inches (76 mm) and 6 inches (152 mm), respectively. The top ply must be back-nailed using corrosion-resistant roofing nails and tin caps as described for the base ply, located a minimum of 1 inch (25.4 mm) from the top edge of the sheet and spaced a maximum of 12 inches (305 mm) on center.

4.2.2 Flashing: Flashing must be installed in accordance with IBC Sections 1503.2 and 1507.3.9, or IRC Sections R903.2 and R905.3.8, as applicable.

4.2.3 Battens: When used, battens must be minimum 1-by-2 pressure-treated wood. The battens must be fastened to the sheathing with three 8d [0.120-inch-diameter (3 mm)] corrosion-resistant ring shank nails for each 4-foot-long (1219 mm) batten. A ¹/₂-inch (12.7 mm) space must be left between the 4-foot-long (1219 mm) battens.

4.2.4 Adhesive Application: Adhesive must be installed in accordance with ICP Construction Inc. dba ICP Building Solutions' published installation instructions. The tile and roof underlayment must be clean and dry at the time of application. The quantity and location of adhesive application must be as determined from [Table 4A](#), [Table 4B](#) and [Figures 1](#) through [4B](#), as applicable. The maximum adhesive-to-tile contact area must not exceed 33 percent of the area of the tile. The adhesive must not be installed under the head lug of the tile or into the side interlock between tiles. The tile must be applied between 1 and 2 minutes after the adhesive has been dispensed. The tiles may be adjusted during that period, provided the tile is not lifted free and clear of the adhesive. If it is necessary to lift the tile free and clear of the adhesive, the adhesive must be reapplied.

Nailing of roof tiles is required as follows:

For roof slopes above 6:12 (27°), the eave course must be fastened with one code-complying nail per tile, in addition to the adhesive.

For roof slopes above 6:12 (27°), up to and including 7:12 (30°), every third tile in every fifth course must be fastened with one code-complying nail, in addition to the adhesive.

For roof slopes above 7:12 (30°), every tile must be nailed in addition to having the adhesive, except for tiles with batten lugs installed over battens. When using battens, tile headlap must be 3 inches (76 mm) unless the roof tile is recognized for other headlaps in the ICC-ES evaluation report on the tile, and preformed flashing with metal edge returns must be used.

Nails must be as specified in the applicable code for roof tile attachment. Plastic cement must be applied to seal all nail penetrations of the underlayment, except when use is made of battens and preformed flashing with metal edge returns.

4.2.5 Hips and Ridges:

4.2.5.1 Hip and Ridge Nailer Board: The nailer board must be of nominal 2-by wood of sufficient height to accommodate the tile profile. The nailer board must be attached to roof framing spaced a maximum of 24 inches (610 mm) on center, using minimum ³/₄-inch-wide (19.1 mm), No. 22 gage, galvanized steel straps or brackets. Each end of the strap or bracket must be fastened to the framing with one corrosion-resistant 10d common or box nail or a No. 8 wood screw, of sufficient length to penetrate the framing a minimum of 1¹/₂ inches (38 mm) for nails and ³/₄ inch (19.1 mm) for screws.

Prior to the installation of the hip and ridge tiles, the junction between the wood nailer board and the field tile may be sealed by application of a bead of ICP Adhesives Polyset® AH-160 on both sides of the nailer board. The hip and ridge tiles must be attached to the nailer board with a ³/₄-inch-thick (19.1 mm), 2-inch-wide (51 mm) bead of adhesive along the full length of the tile excluding 2 inches (51 mm) of the eave-end of the tile, ensuring 30-35 in² (193.5-225.8 cm²) of adhesive coverage on the underside of the tile (See [Figure 4A](#)) or with one #10 x 2 ¹/₂" screw used to secure the head of tile and a 1x6" bead of adhesive at the overlap. (See [Figure 4B](#)).

4.2.5.2 Metal Hip and Ridge Frame: Metal frames for hips and ridges must be minimum No. 26 gage, galvanized, preformed steel having a 2³/₈-inch (60.3 mm) to 4-inch-wide (102 mm) top with a ¹/₂-inch (12.7) dip in the center of sufficient height to accommodate the tile profile. The metal frame must be attached to minimum

$15/32$ -inch-thick (11.9 mm) roof deck using $1\frac{1}{4}$ -inch-long (31.8 mm), 0.120-inch-diameter (3 mm [No. 11 gage]), hot-dipped galvanized ring-shank or smooth roofing nails spaced at 6 inches (152 mm) on center on each side of the ridge or hip.

Before installation of the hip and ridge tiles, the junction between the metal frame and the field tile may be sealed by application of a bead of ICP Adhesives Polyset® AH-160 on both sides of the support member. The hip and ridge tiles must be attached to the metal frame with a $3/4$ -inch-thick (19.1 mm), 2-inch-wide (51 mm) bead of adhesive along the full length of the tile excluding 2 inches (51 mm) on the eave-end of the tile, ensuring 30-35 in² (193.5-225.8 cm²) of adhesive coverage on the underside of the tile (See [Figure 4A](#)).

4.2.5.3 Hip and Ridge Channels:

4.2.5.3.1 Trim Lock: Trim Lock must be attached using minimum 0.120-inch-diameter (No. 11 gage) x $1\frac{1}{4}$ inch long x $3/8$ inch head diameter (3 mm x 32 mm x 10 mm) galvanized annular ring shank nails spaced 6 inches on center along both deck-flanges. Fasteners must be positioned $3/4$ inch (19 mm) from the outside edge of each deck-flange, and set in a bed of plastic roof cement.

4.2.5.3.2 Trim Lock Plus: Trim Lock Plus is attached to the underlayment with a continuous 2 inch (51 mm) wide bead of ICP Adhesives Polyset® AH-160 on each flange.

4.2.5.4 Roof Classification: When concrete and clay tiles recognized in an ICC-ES evaluation report are adhered in accordance with this report using ICP Adhesives Polyset® AH-160, the roofing systems must maintain their respective roof fire classifications provided the tiles conform to Section 3.5 of this report.

5.0 CONDITIONS OF USE:

The ICP Adhesives Polyset® AH-160 described in this report comply with, or are suitable alternatives to what is specified in, those codes listed in Section 1.0 of this report, subject to the following conditions:

- 5.1 The product must be installed in accordance with this report, the manufacturer's instructions and the applicable code. In the event of a conflict between the manufacturer's instructions and this report, this report governs.
- 5.2 Adhesive application of tiles is limited to conventional code-prescribed concrete and clay roofing tiles conforming to Section 3.5 of this report. The concrete and clay roofing tiles must be recognized in a current ICC-ES evaluation report permitting adhesive application.
- 5.3 Adhesive application must be in accordance with Section 4.2.4 of this report.
- 5.4 Installation of roof tiles with the adhesive system is restricted to areas in which the mean rainfall does not exceed 20 inches (508 mm) and the average of the daily lows for any month is at least 30°F (-1.1°C).
- 5.5 ICP Adhesives Polyset® AH-160 is manufactured in Tomball, TX, under a quality-control program with inspections provided by ICC-ES.

6.0 EVIDENCE SUBMITTED

Data and reports of tests in accordance with the [ICC-ES Acceptance Criteria for Adhesive Attachment of Concrete or Clay Roofing Tiles \(AC152\)](#), dated February 2016 (editorially revised June 2021).

7.0 IDENTIFICATION

- 7.1 The ICC-ES mark of conformity, electronic labeling or the evaluation report number (ICC-ES ESR-1709) along with the name, registered trademark, or registered logo of the report holder must be included in the product label.
- 7.2 In addition, containers of ICP Adhesives Polyset® AH-160 are labeled with the ICP Construction Inc. dba ICP Building Solutions. name and address, the product name, the batch number, and the evaluation report number ESR-1709. "A" components are identified with a red label; "B" components are identified with a blue label.
- 7.3 The report holder's contact information is the following:

**ICP CONSTRUCTION INC.
DBA ICP BUILDING SOLUTIONS
150 DASCUMB ROAD
ANDOVER, MASSACHUSETTS 01810
(866) 667-5119
www.icpadhesives.com**

TABLE 1—ALLOWABLE UPLIFT RESISTANCE FOR THE SINGLE-PLY UNDERLAYMENT SYSTEM

SINGLE-PLY UNDERLAYMENT FASTENING SYSTEM – (ONE ROW IN FIELD)(DIRECT TO DECK)							
Attachment ¹	Field (inches o/c)	Lap (inches o/c)	Backnail Cap Sheet (inches o/c)	Allowable Uplift Resistance (psf)			
				15/32"		19/32"	
				Smooth	Deformed ²	Smooth	Deformed ²
One row in the field, one row at the lap. (Direct to Deck)	12	6	N/A	23.8	27.1	30.2	34.3
	9	6	N/A	26.5	30.1	33.5	38.1
	6	6	N/A	31.8	36.1	40.2	45.7
	3	6	N/A	47.6	54.2	60.4	68.6

SINGLE-PLY UNDERLAYMENT FASTENING SYSTEM – (TWO ROWS IN FIELD)(DIRECT TO DECK)							
Attachment ¹	Field (inches o/c)	Lap (inches o/c)	Backnail Cap Sheet (inches o/c)	Allowable Uplift Resistance (psf)			
				15/32"		19/32"	
				Smooth	Deformed ²	Smooth	Deformed ²
Two rows staggered in field, one row at the lap. (Direct to Deck)	12	6	N/A	33.8	38.4	42.8	48.6
	9	6	N/A	39.0	44.4	49.5	56.2
	6	6	N/A	49.6	56.5	62.9	71.5
	3	6	N/A	81.4	92.6	103.1	117.2

SINGLE-PLY UNDERLAYMENT FASTENING SYSTEM – (THREE ROWS IN FIELD)(DIRECT TO DECK)							
Attachment ¹	Field (inches o/c)	Lap (inches o/c)	Backnail Cap Sheet (inches o/c)	Allowable Uplift Resistance (psf)			
				15/32"		19/32"	
				Smooth	Deformed ²	Smooth	Deformed ²
Three rows staggered in the field, on row at the lap. (Direct to Deck)	12	6	N/A	41.7	47.4	52.8	60.0
	9	6	N/A	49.6	56.5	62.9	71.5
	6	6	N/A	65.5	74.5	83.0	94.3
	3	6	N/A	113.2	128.8	143.3	163.0

For SI: 1 inch = 25.4 mm, 1 psf = 0.0479 kPa.

¹See Section 4.2.1 for fasteners.

²Deformed shank is inclusive of either a ring or screw shank nail.

TABLE 2—ALLOWABLE UPLIFT RESISTANCE FOR THE SINGLE-PLY UNDERLAYMENT WITH BATTENS SYSTEM

SINGLE-PLY WITH BATTENS UNDERLAYMENT FASTENING SYSTEM – (ONE ROW IN FIELD)							
Attachment ¹	Field (inches o/c)	Lap (inches o/c)	Backnail Cap Sheet (inches o/c)	Allowable Uplift Resistance (psf)			
				15/32"		19/32"	
				Smooth	Deformed ²	Smooth	Deformed ²
One row in the field, one row at the lap, and battens ³ 14" o/c.	12	6	N/A	40.3	43.6	51.0	55.1
	9	6	N/A	42.9	46.6	54.4	59.0
	6	6	N/A	48.2	52.6	61.1	66.6
	3	6	N/A	64.1	70.7	81.2	89.4

SINGLE-PLY WITH BATTENS UNDERLAYMENT FASTENING SYSTEM – (TWO ROWS IN FIELD)							
Attachment ¹	Field (inches o/c)	Lap (inches o/c)	Backnail Cap Sheet (inches o/c)	Allowable Uplift Resistance (psf)			
				15/32"		19/32"	
				Smooth	Deformed ²	Smooth	Deformed ²
Two rows staggered in the field, one row at the lap, and battens ² 14" o/c.	12	6	N/A	50.2	54.9	63.6	69.4
	9	6	N/A	55.5	60.9	70.3	77.0
	6	6	N/A	66.1	72.9	83.7	92.3
	3	6	N/A	97.8	109.7	123.9	138.0

SINGLE-PLY WITH BATTENS UNDERLAYMENT FASTENING SYSTEM – (THREE ROWS IN FIELD)							
Attachment ¹	Field (inches o/c)	Lap (inches o/c)	Backnail Cap Sheet (inches o/c)	Allowable Uplift Resistance (psf)			
				15/32"		19/32"	
				Smooth	Deformed ²	Smooth	Deformed ²
Three rows staggered in the field, one row at the lap, and battens ³ 14" o/c.	12	6	N/A	58.2	63.9	73.6	80.9
	9	6	N/A	66.1	72.9	83.7	92.3
	6	6	N/A	82.0	91.0	103.8	115.2
	3	6	N/A	129.6	145.2	164.2	183.8

For SI: 1 inch = 25.4 mm, 1 psf = 0.0479 kPa.

¹See Section 4.2.1 for fasteners.

²Deformed shank is inclusive of either a ring or screw shank nail.

³Batten density was based on 3 – 8d – 0.120 -inch diameter ring shank nails per 4 foot batten, spaced 14 inches o.c.

TABLE 3—ALLOWABLE UPLIFT RESISTANCE FOR THE TWO-PLY UNDERLAYMENT SYSTEM

TWO-PLY UNDERLAYMENT FASTENING SYSTEM - (TWO ROWS IN FIELD)							
Attachment ¹	Field (inches o/c)	Lap (inches o/c)	Backnail Cap Sheet (inches o/c)	Allowable Uplift Resistance (psf)			
				15/32"		19/32"	
				Smooth	Deformed ²	Smooth	Deformed ²
Two rows staggered in the field, one row at the lap and one row at the top of the cap sheet edge.	12	6	12	41.6	47.4	52.7	60.0
	9	6	12	47.0	53.5	59.5	67.7
	6	6	12	57.6	65.5	72.9	82.9
	3	6	12	89.3	101.6	113.2	128.6

TWO-PLY UNDERLAYMENT FASTENING SYSTEM - (THREE ROWS IN FIELD)							
Attachment ¹	Field (inches o/c)	Lap (inches o/c)	Backnail Cap Sheet (inches o/c)	Allowable Uplift Resistance (psf)			
				15/32"		19/32"	
				Smooth	Deformed ²	Smooth	Deformed ²
Three rows staggered in the field, one row at the lap and one row at the top of the cap sheet edge.	12	6	12	49.6	56.5	62.9	71.5
	9	6	12	57.6	65.5	72.9	82.9
	6	6	12	73.5	83.6	93.0	105.8
	3	6	12	121.1	137.8	153.4	174.4

TWO-PLY UNDERLAYMENT FASTENING SYSTEM - (FOUR ROWS IN FIELD)							
Attachment ¹	Field (inches o/c)	Lap (inches o/c)	Backnail Cap Sheet (inches o/c)	Allowable Uplift Resistance (psf)			
				15/32"		19/32"	
				Smooth	Deformed ²	Smooth	Deformed ²
Four rows staggered in the field, one row at the lap and one row at the top of the cap sheet edge.	12	6	12	58.6	66.6	74.2	84.3
	9	6	12	69.2	78.7	87.6	99.6
	6	6	12	90.3	102.8	114.4	130.1
	3	6	12	153.9	175.1	194.9	221.6

For SI: 1 inch = 25.4 mm. 1 psf = 0.0479kPa.

¹See Section 4.2.1 for fasteners.

²Deformed shank is inclusive of either a ring or screw shank nail.

TABLE 4A—ALLOWABLE AERODYNAMIC UPLIFT MOMENT VALUES — FIELD TILE

PROFILE ¹	MATERIAL	PADDY ^{2,3}	ALLOWABLE AERODYNAMIC UPLIFT MOMENT (ft-lb) ⁴
High	Clay	Single Paddy (Independent) / Large (10"x2") (~45 gram)	129
	Concrete	Single Paddy (Independent) / Large (10"x2") (~63 gram)	102
	Concrete or Clay	Single Paddy (Independent) / Medium (7"x2") (~30 gram)	57
	Concrete or Clay	Two Paddy (Interdependent) (4"x4" & 2"x4") (~12 gram per paddy)	32
Medium	Concrete or Clay	Single Paddy (Independent) / Large (10"x2") (~54 gram)	61
	Concrete or Clay	Single Paddy (Independent) / Medium (7"x2") (~30 gram)	33
	Concrete or Clay	Two Paddy (Interdependent) (4"x4" & 2"x4") (~12 gram per paddy)	52
Low/Flat	Concrete or Clay	Single Paddy (Independent) / Large (10"x2") (~45 gram)	104
	Concrete or Clay	Single Paddy (Independent) / Medium (7"x2") (~30 gram)	52
	Concrete or Clay	Two Paddy (Interdependent) (4"x4" & 2"x4") (~12 gram per paddy)	46
2-Piece Barrel	Clay	2x10-inch (~35 gram) for pans; 2 @ 1x10-inch (~17 gram) for cap	143
	Concrete	2x10-inch (~35 gram) for pans; 2 @ 1x10-inch (~17 gram) for cap	101

For SI: 1 inch = 25.4 mm 1 psf = 0.0479 kPa.

¹ See Section 3.5 for definition of tile profiles.

² See Figures 1 through 3 for typical installation details (approximate size and placement) of the paddy.

³ Select a paddy size and placement with an allowable uplift moment equal to or greater than the required aerodynamic uplift moment as determined in accordance with Section 4.1.3 of this report.

⁴ The tabulated allowable aerodynamic uplift moment is for the fixing (adhesive) only.

TABLE 4B—ALLOWABLE UPLIFT FORCE – HIP/RIDGE TILES

HIP/RIDGE TILE MATERIAL	SUBSTRATE	PADDY ^{1,2}	ALLOWABLE UPLIFT FORCE (lb) ³
Clay	2x wood stringer/ridge board	2" Bead Length of Tile less 2 inches (Independent Paddy) (~34 gram/ft)	111
		Interdependent Paddy (~10.5 gram) with #10 x 2 1/2" screw at head of tile and a 1x6" bead of adhesive at the overlap	85
Concrete	2x wood stringer/ridge board	2" Bead Length of Tile less 2 inches (Independent Paddy) (~34 gram/ft)	102
		Interdependent Paddy (~10.5 gram) with #10 x 2 1/2" screw at head of tile and a 1x6" bead of adhesive at the overlap	65
Concrete or Clay	Trim Lock™ (Aluminum, Galvanized, Galvalume)	1 1/2" Bead Length of Tile less 2 inches (~34 gram/ft)	160
	Trim Lock™ Plus (Aluminum, Galvanized, Galvalume)	1 1/2" Bead Length of Tile less 2 inches (~34 gram/ft)	155

For SI: 1 inch = 25.4 mm 1 psf = 0.0479 kPa.

¹ See Figures 1 through 4 for typical installation details (approximate size and placement) of the paddy.

² Select a paddy size and placement with an allowable uplift moment equal to or greater than the required aerodynamic uplift moment as determined in accordance with Section 4.1.3 of this report.

³ The tabulated allowable uplift force is for the fixing (adhesive) only.

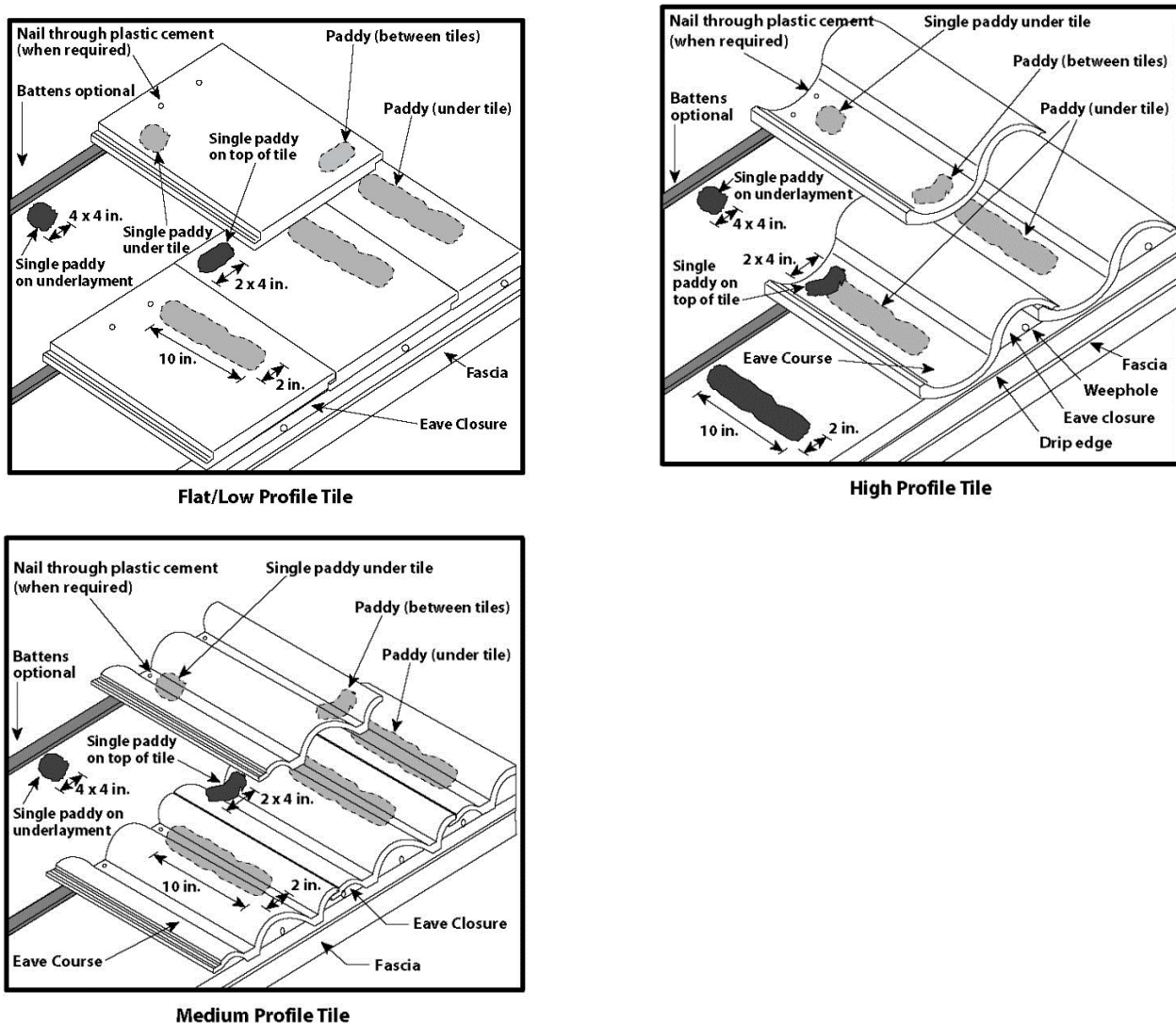
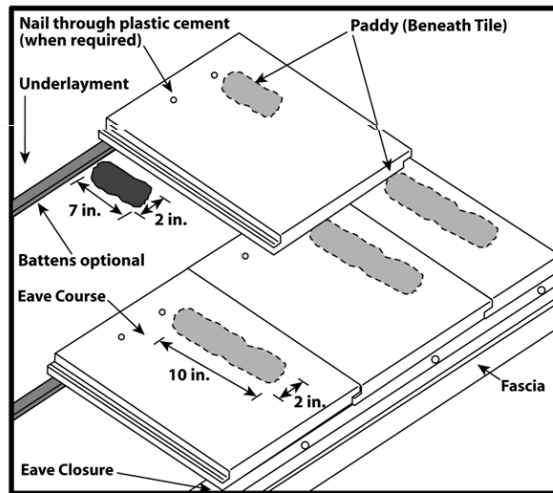
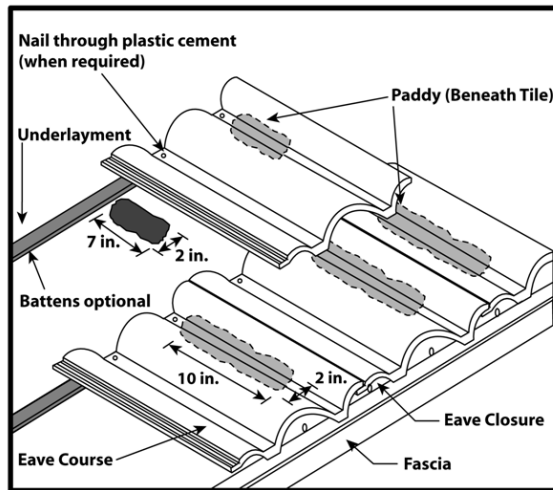

FIGURE 1—TWO PADDY PLACEMENT



Flat/Low Profile Tile



Medium Profile Tile

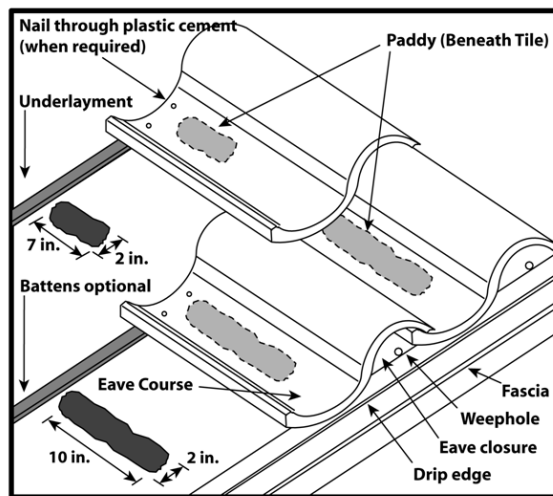

High Profile Tile

FIGURE 2—MEDIUM PADDY PLACEMENT

Large Paddy Placement

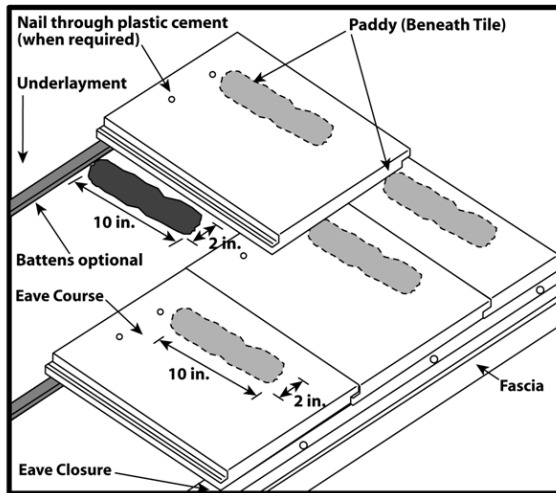

Flat/Low Profile Tile

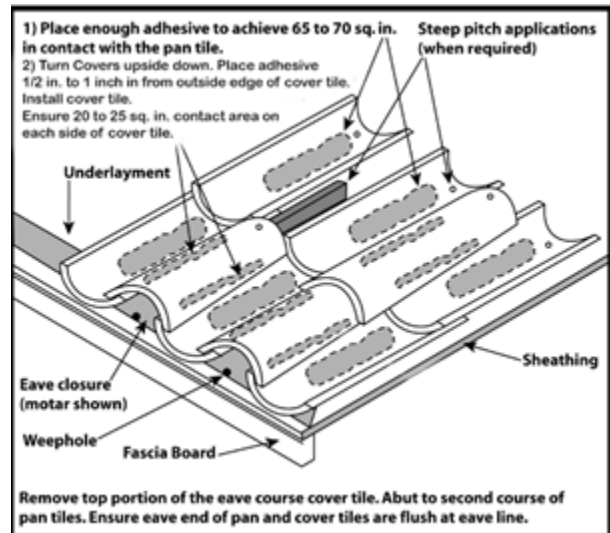

Two Piece Barrel - High Profile Tile

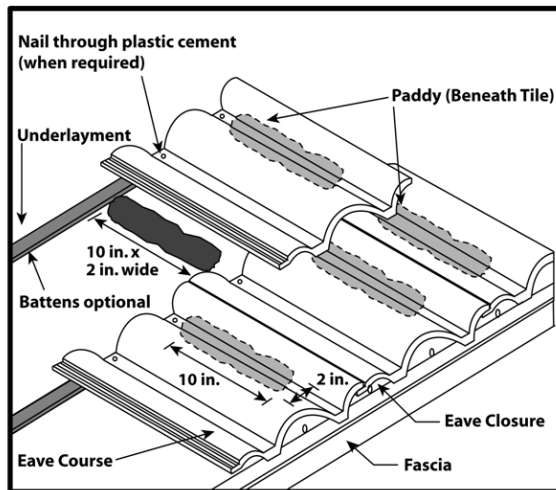

Medium Profile Tile

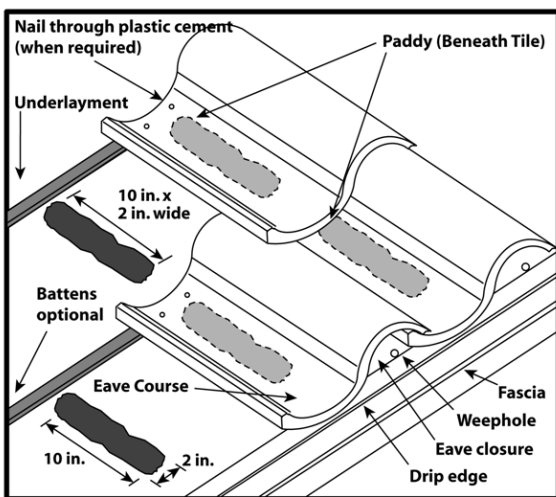

High Profile Tile

FIGURE 3—LARGE PADDY PLACEMENT

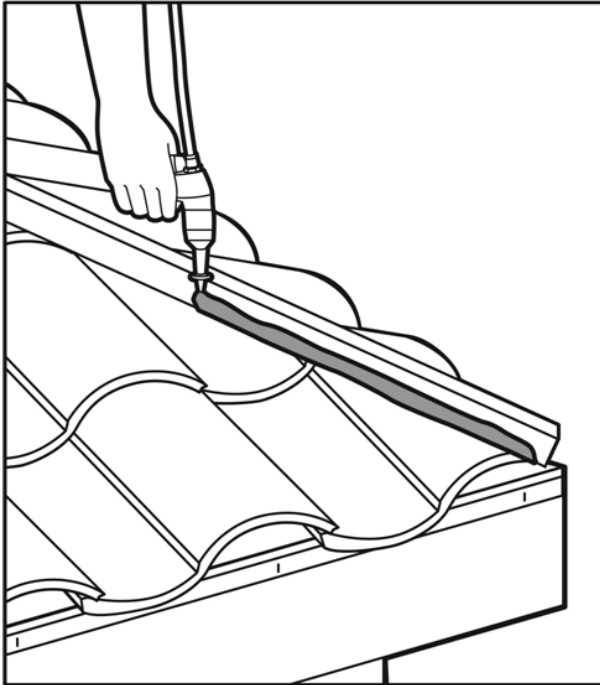

A bead of ICP Polyset®AH-160 may be applied above the field tile surface on both sides of the hip/ridge board or galvanized metal frame to provide weatherblocking.

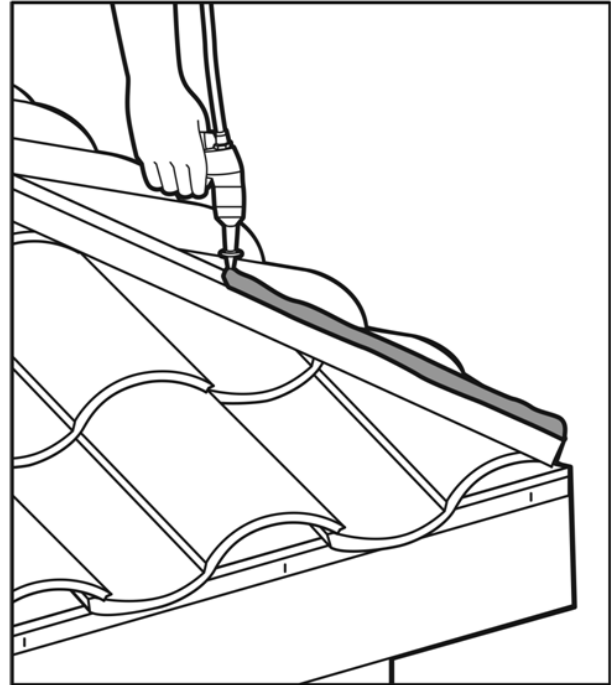

To attach hip/ridge tiles, a bead of ICP Polyset®AH-160 may be applied down the center of the hip/ridge board or galvanized frame.

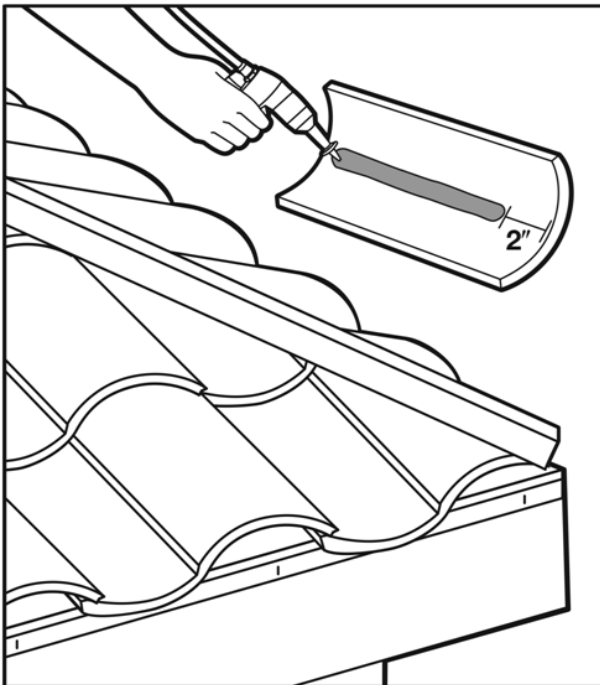

To attach hip/ridge tiles, a bead of ICP Polyset®AH-160 roof tile adhesive may be applied along the full length of the tile excluding 2 inches excluding 2 inches on the eave end of tile.

FIGURE 4A—INDEPENDENT APPLICATION - HIP AND RIDGE

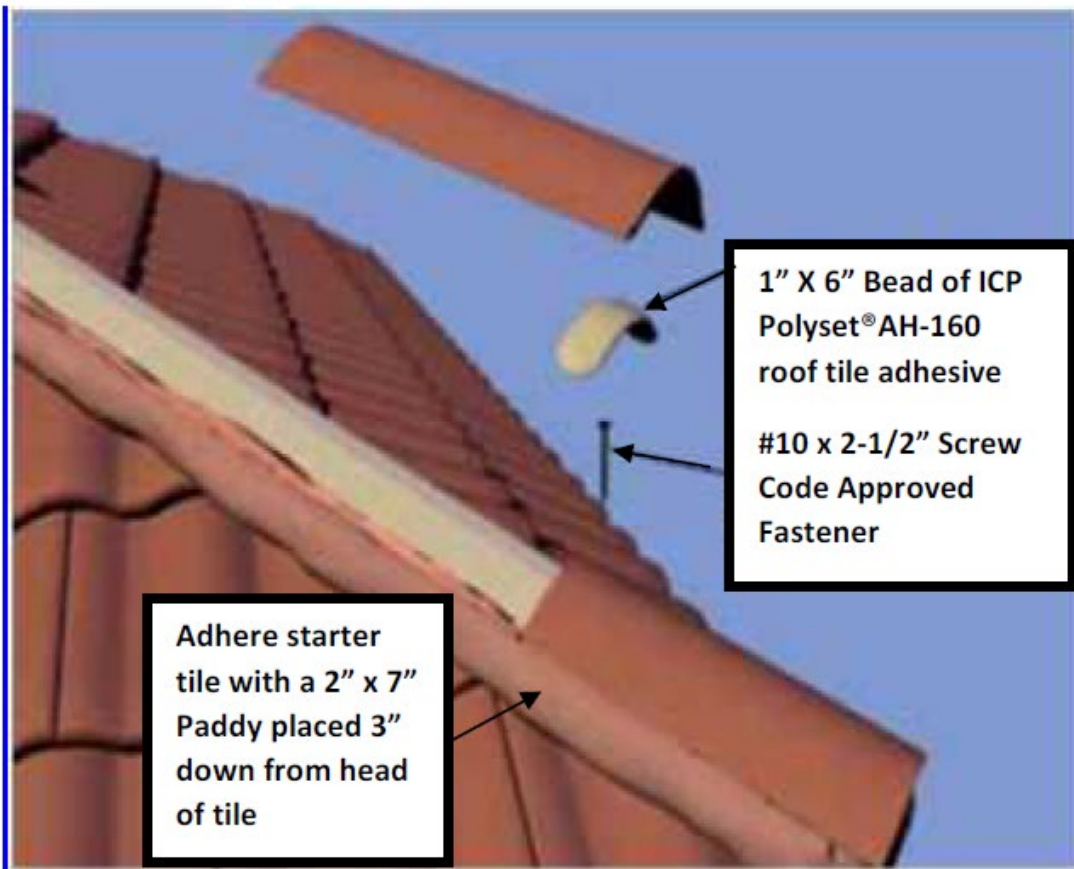

FIGURE 4B—INTERDEPENDANT APPLICATION – HIP AND RIDGE

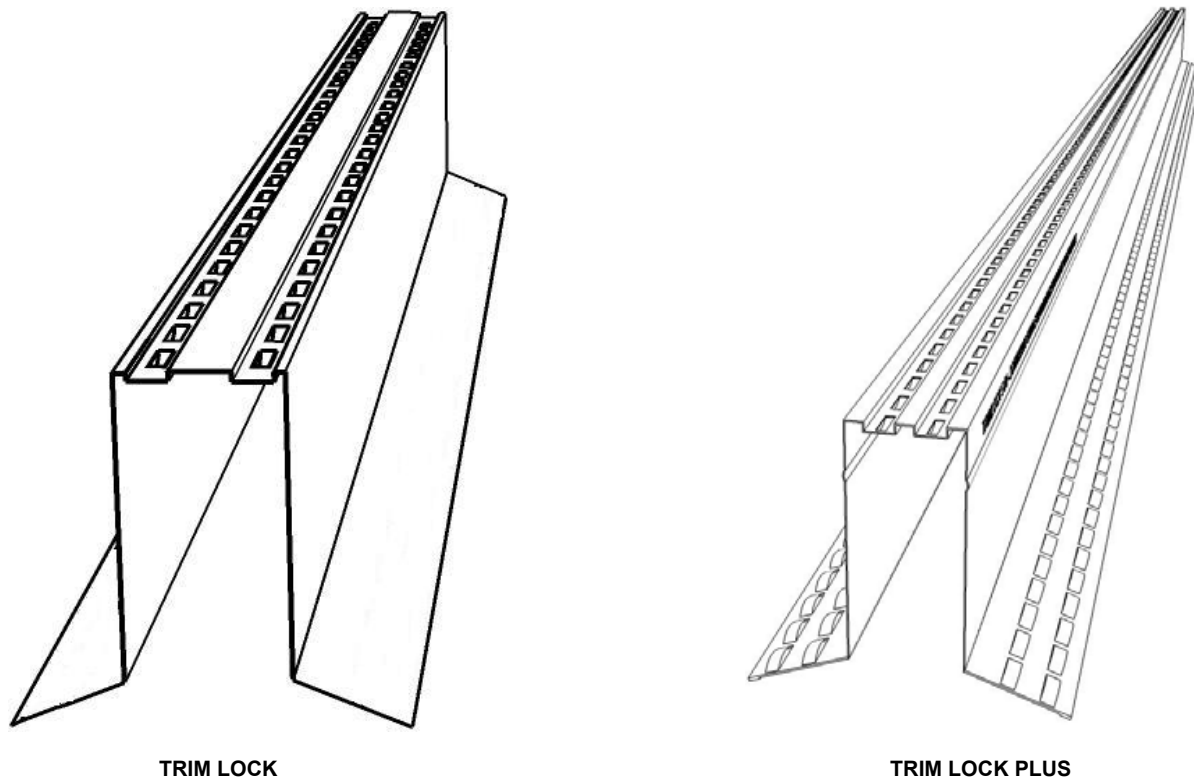

FIGURE 5—TRIM LOCK AND TRIM LOCK PLUS

Installation Verification Card

Date: _____

Permit Number: _____

Project Name or Owner: _____

Phone Number: _____

Project Address: _____

Tile Manufacturer and Tile Profile : _____

Required Aerodynamic Uplift Moment (ft.lbs): _____

Paddy Placement to be used: _____

Allowable Uplift Moment (ft.lbs): _____

(See ICC-ES ESR-1709 Section 4.1.3 for required aerodynamic uplift moment, [Tables 4A](#) and [4B](#) for allowable uplift moment for each tile type and paddy size and [Figures 1, 2](#) or [3](#) for paddy placement)

Note: Installer must check a minimum of 1 tile per square for the following paddy placement, contact area, and cured adhesive paddy properties:

Two Paddy Placement	Underside of tile Contact Area:
Flat/Low Profile Tile: Verify 4" X 4" x 1" paddy is applied just below second course line under the strengthening rib closest to the underlock side strengthening rib. * Apply a second 2" x 4" x 3/4" paddy on top of the course below the tile to be installed and position paddy on top of the strengthening rib nearest the underlock side of that tile. Apply tile in staggered pattern.	Min. 8-9 sq. in. *Min. 9-11 sq. in.*
Double Roll-Medium Profile Tile: Verify 4" X 4" x 1" paddy is applied just below course line under the pan portion of the tile, closest to the underlock side of the tile to be installed. * Apply a second 2" x 4" x 3/4" paddy on top of the course below the tile to be installed and position paddy over the pan portion of tile, closest to overlock side of that tile. Apply tile in staggered pattern.	Min. 8-9 sq. in. *Min. 9-11 sq. in.
Single Pan-High Profile Tile: Verify 4" X 4" x 1" paddy is applied just below second course line under the strengthening rib closest to the underlock side of the second course tile to be installed. * Apply a second 2" x 4" x 3/4" paddy on top of the course below the tile to be installed and position paddy over the pan portion of the tile, closest to the strengthening rib nearest the overlock side of that tile.	Min. 8-9 sq. in. *Min. 9-11 sq. in.
Eave Course - All Tile Profile: Verify 2"(w) x 10"(l) paddy is applied 3-4" from head of tile opposite the eave-end of the tile.	Min. 17-23 sq. in.

Medium Paddy Placement	Underside of tile Contact Area:
Flat/Low Profile Tile: Verify 2"(w) x 7"(l) paddy is applied 2-3" from head of tile placed under the overlock side strengthening rib.	Min. 10-12 sq. in.
Double Roll - Medium Profile Tile: Verify 2"(w) x 7"(l) paddy is applied 2-3" from head of tile placed under the pan of the overlock side.	Min. 12-14 sq. in.
Single Pan - High Profile Tile: Verify 2"(w) x 7"(l) paddy is applied 2-3" from head of tile placed under the pan portion of the tile.	Min. 17-19 sq. in.
Eave Course - All Tile Profile: Verify 2"(w) x 10"(l) paddy is applied 3-4" from head of the tile opposite the eave-end of the tile.	Min. 17-23 sq. in.

Large Paddy Placement	Underside of tile Contact Area:
Flat/Low Profile Tile: Verify 2"(w) x 10"(l) paddy is applied 3-4" from head of tile placed under the overlock side strengthening rib.	Min. 17-23 sq. in.
Double Roll-Medium Profile Tile: Verify 2"(w) x 10"(l) paddy is applied 3-4" from head of tile placed under the pan of the overlock side.	Min. 17-23 sq. in.
Single Pan - High Profile Tile: Verify 2"(w) x 10"(l) paddy is applied 3-4" from head of tile placed under the pan portion of the tile.	Min. 17-23 sq. in.
Eave Course - All Tile Profile: Verify 2"(w) x 10"(l) paddy is applied 3-4" from head tile opposite the eave-end of the tile.	Min. 17-23 sq. in.

Two-Piece Barrel (Cap and Pan Tile)	Underside of tile Contact Area:
Pan Tiles: Verify 2"(w) x 10"(l) paddy is applied 3-4" from head of tile placed under the pan tile.	Min. 65-70 sq. in.
Cap Tiles: Verify 1"(w) x 10"(l) bead is applied 3-4" from the head of the tile placed 1" in from each longitudinal edge of the cover tile.	Min. 20-25 sq. in.

Hip and Ridge	Underside of tile Contact Area:
Hip or Ridge Tiles Apply 2" x 7" paddy centered on underside of tile or apply continuous bead of adhesive onto ridge support member.	Min. 30-35 sq. in.
Hip or Ridge Tiles Interdependent Paddy with one #10 x 2 1/2" screw at head of tile and a 1" x 6" bead of adhesive at the overlap.	Min. 10-15 sq. in.

By my signature below, I verify I have checked a minimum of 1 tile per square of tile installed and the foam adhesive paddies are not soft/spongy or brittle/crunchy, the adhesive paddy placement is correct, and the appropriate contact area has been met for the applicable system:

Qualified Applicator Name (print), Signature and Date: _____
ICP Construction Inc. dba ICP Building Solutions. Qualified Applicator ID #: _____

FIGURE 6—INSTALLATION VERIFICATION CARD