



Most Widely Accepted and Trusted

ICC-ES Evaluation Report

ESR-2540

ICC-ES | (800) 423-6587 | (562) 699-0543 | www.icc-es.org

Reissued 08/2018
This report is subject to renewal 08/2020.

DIVISION: 03 00 00—CONCRETE
SECTION: 03 54 00—CEMENTITIOUS UNDERLAYMENT

REPORT HOLDER:

MAXXON CORPORATION

EVALUATION SUBJECT:

MAXXON GYPSUM CONCRETE UNDERLAYMENTS: GYP-CRETE®, GYP-CRETE 2000®/3.2K, THERMA-FLOOR®, DURA-CAP®, ORTECRETE®, RAPID FLOOR®, RAPID FLOOR® PLUS, RAPID FLOOR® ULTRA, RAPID RADIANT®, AND COMMERCIAL TOPPING® MAXXON CEMENTITIOUS UNDERLAYMENTS: LEVEL-RIGHT® AND MAXXEXTERIOR DEK C-MENT®



“2014 Recipient of Prestigious Western States Seismic Policy Council (WSSPC) Award in Excellence”



ICC-ES Evaluation Reports are not to be construed as representing aesthetics or any other attributes not specifically addressed, nor are they to be construed as an endorsement of the subject of the report or a recommendation for its use. There is no warranty by ICC Evaluation Service, LLC, express or implied, as to any finding or other matter in this report, or as to any product covered by the report.



ICC-ES Evaluation Report

ESR-2540

Reissued August 2018

This report is subject to renewal August 2020.

www.icc-es.org | (800) 423-6587 | (562) 699-0543

A Subsidiary of the International Code Council®

DIVISION: 03 00 00—CONCRETE

Section: 03 54 00—Cementitious Underlayment

REPORT HOLDER:

MAXXON CORPORATION

EVALUATION SUBJECT:

MAXXON GYPSUM CONCRETE UNDERLAYMENTS: GYP-CRETE®, GYP-CRETE 2000®/3.2K, THERMA-FLOOR®, DURA-CAP®, ORTECRETE®, RAPID FLOOR®, RAPID FLOOR® PLUS, RAPID FLOOR® ULTRA, RAPID RADIANT®, AND COMMERCIAL TOPPING® MAXXON CEMENTITIOUS UNDERLAYMENTS: LEVEL-RIGHT® AND MAXXEXTERIOR DEK C-MENT®

1.0 EVALUATION SCOPE

Compliance with the following codes:

- 2015, 2012 and 2009 *International Building Code*® (IBC)
- 2015, 2012 and 2009 *International Residential Code*® (IRC)
- 2013 *Abu Dhabi International Building Code* (ADIBC)[†]

[†]The ADIBC is based on the 2009 IBC. 2009 IBC code sections referenced in this report are the same sections in the ADIBC.

Properties evaluated:

- Sound transmission
- Fire-resistance-rated construction

2.0 USES

Maxxon Gypsum Concrete Underlayments are used as floor toppings and floor leveling agents. The underlayments are used in fire-resistance-rated floor/ceiling assemblies in accordance with IBC Section 703 and IRC Section R302 when installed in accordance with Section 4.1. The underlayments are used in sound-transmission-rated floor/ceiling assemblies in accordance with IBC Section 1207 and IRC Appendix K when installed and used in accordance with Section 4.2.

Therma-Floor® and Rapid Radiant® gypsum concrete poured floor underlayments are used in radiant heating applications using embedded hot water tubes or electric heating cables.

3.0 DESCRIPTION

Gyp-Crete®, Gyp-Crete 2000®/3.2K, Therma-Floor®, Dura-Cap®, Ortecrete®, Rapid Floor®, Rapid Floor® Plus, Rapid Floor® Ultra, Rapid Radiant®, and Commercial Topping®

are gypsum concrete, poured floor underlayments. Each product may be used for a variety of applications, and mixed in accordance with the manufacturer's specifications at various densities between 110 and 120 pcf (1.7–1.9 kg/m³) for a minimum 28-day compressive strength of 1 ksi (6.9 MPa), based on testing in accordance with ASTM C472. Therma-Floor and Rapid Radiant are used in radiant heating applications in both residential and commercial construction. Level-Right is a self-leveling, cementitious poured floor underlayment that can be used to level concrete or wood subfloors. MaxxExterior Dek C-Ment® is a cementitious underlayment for interior and exterior use on floors supported by code-complying wood frame, steel deck and concrete construction. The shelf-life information is included in the material specification sheets distributed to all Maxxon Corporation authorized applicators.

Maxxon underlayments are used with various Maxxon sound mats (see Table 1) and other products, including Maxxon Crack Suppression Mat (CSM), Maxxon Reinforcement (MR), Maxxon Floor Primer, and Maxxon Acrylic coating as components of floor/ceiling assemblies.

4.0 INSTALLATION

Maxxon underlayments must be installed in accordance with the manufacturer's published installation instructions. The underlayments are mixed with sand and water on the jobsite and pumped into place by Maxxon Corporation approved installers. The underlayments must have minimum density and compressive strength as specified in Section 3.0 of this report and the manufacturer's published installation instructions or, when applicable, as specified for the fire-resistance-rated assemblies described in Section 4.1. The underlayments are installed over the sound mats listed in Table 1.

4.1 Fire-resistance-rated Floor/Ceiling Assemblies:

4.1.1 1-hour and 2-hour Fire-resistance-rated Floor/Ceiling Assemblies: The 1-hour fire-resistance-rated floor/ceiling assemblies shown in Figures 6 through 9, and the 2-hour fire-resistance-rated floor/ceiling assembly shown in Figure 10, are based on UL designs. When using these assemblies, all details must be in accordance with the specifications contained in the UL *BXUV GuideInfo*. Dek C-Ment may be substituted for Dura-Cap in any of the assemblies shown in Figures 6 through 10.

4.1.2 1-hour Fire-resistance-rated Floor/Ceiling Assemblies Incorporating Wood Joists: Floor assemblies consisting of nominally 2-by-10-inch wood joists spaced 16 inches (406 mm) on center, with a 5/8-inch-thick (15.9 mm) Type X gypsum ceiling board

fastened with 1-inch (25.4 mm) Type S screws, spaced 12 inches (305 mm) on center to 1¹/₂-inch-wide (38.1 mm), No. 25 gage [0.021 inch (0.538 mm)] resilient channels, which are fastened to each joist with 1¹/₄-inch (31.8 mm) Type W or S screws, a ⁵/₈-inch-thick (15.9 mm) plywood subfloor and minimum ³/₄-inch-thick (19.1 mm) Maxxon underlayment topping and covered with one of the floor coverings as described in items 1 through 6 below, qualify as 1-hour fire-resistance-rated assemblies.

1. Residential high-grade carpet and cushion: 80-ounce-per-square-yard (2.7 kg/m²), 0.97-inch (25 mm) pile carpet and ⁹/₁₆-inch (14.3 mm) solid urethane-foam pad with reflective silver scrim with or without 3-inch-thick (76 mm) fiberglass insulation in the ceiling cavity.
2. Residential medium-grade carpet and cushion: 50-ounce-per-square-yard (1.7 kg/m²), 0.59-inch (15 mm) pile carpet and ¹/₂-inch (12.7 mm) marbled urethane-foam pad with clear scrim with 3-inch-thick (76 mm) fiberglass insulation in the ceiling cavity.
3. Residential low-grade carpet and cushion: 24-ounce-per-square-yard (0.814 kg/m²), 0.25-inch (6.4 mm) pile carpet and ⁹/₁₆-inch (14.3 mm) marbled foam pad with clear scrim with or without 3-inch-thick (76 mm) fiberglass insulation in the ceiling cavity.
4. Commercial high-grade carpet and cushion: 58-ounce-per-square-yard (1.97 kg/m²), 0.437-inch (11 mm) pile carpet and 0.265-inch (6.7 mm), 5 pcf (80 kg/m³) prime urethane pad with or without 3-inch-thick (76 mm) fiberglass insulation in the ceiling cavity.
5. Commercial medium-grade carpet and cushion: 48-ounce-per-square-yard (1.63 kg/m²), 0.375-inch (9.5 mm) pile carpet and 0.265-inch (6.7 mm), 4 pcf (64 kg/m³) prime urethane pad with or without 3-inch-thick (76 mm) fiberglass insulation in the ceiling cavity.
6. Commercial low-grade carpet and pad: 22-ounce-per-square-yard (0.746 kg/m²), 0.203-inch (5.2 mm) pile carpet and 0.25-inch (6.4 mm) solid yellow urethane pad with 3-inch-thick (76 mm) fiberglass insulation in the ceiling cavity.

4.2 Sound-transmission-rated Floor/ceiling Assemblies:

The assemblies pictured in Figures 1 through 5, which feature simplified descriptions of the fire-resistance-rated assemblies detailed in Figures 6 through 10, respectively, have a minimum Sound Transmission Class (STC) of 50 and a minimum Impact Isolation Class (IIC) of 50. The manufacturer-specified minimum poured underlayment depth over sound mats is as described in Table 1 for sound rated assemblies. The sound mat shown in Figures 1 through 5 can be removed from the assembly and have the assembly still maintain its sound rating, if carpet and pad are utilized as the floor covering materials. Table 1 identifies the minimum thickness of the underlayment needed if the sound mat is removed.

The assemblies described in Section 4.1.2 are sound-transmission-rated assemblies with a minimum STC of 50 and a minimum IIC of 50.

Care must be taken during the selection and installation of all building components to achieve the stated sound-transmission ratings. Sound flanking paths such as penetrations or openings in construction assemblies must

be sealed, lined, insulated, or otherwise treated to maintain the required ratings in accordance with Section 1207 of the IBC or Appendix K of the IRC, as applicable.

4.3 Alternate One-hour Fire-resistance-rated Construction to Double Wood Floor Assembly Shown in 2015 and 2012 IBC Table 721.1(3) (2009 IBC Table 720.1(3)) (Footnote m):

As an alternate to the double wood floor, ⁵/₈-inch-thick (15.9 mm) plywood subfloor covered with ³/₄-inch-thick (19.1 mm) underlayment, with one coat of latex bonder applied to the subfloor prior to installation of the underlayment, is acceptable. The latex bonder liquid latex, 48-50 percent solids diluted 1:1 with water, is applied at a rate of 300 square feet per gallon (7.4 m²/L).

Note: Since Footnote n of IBC Table 721.1(3) [2009 IBC Table 720.1(3)] applies to the assembly described in Footnote m of IBC Table 721.1(3) [2009 IBC Table 720.1(3)], they also apply to the alternate assembly described above.

5.0 CONDITIONS OF USE

The underlayments described in this report comply with, or are suitable alternatives to what is specified in, those codes listed in Section 1.0 of this report, subject to the following conditions:

- 5.1 Installation must comply with this report, the manufacturer's published instructions and the applicable code. In the event of a conflict between the manufacturer's published installation instructions and this report, this report governs.
- 5.2 Installation is by applicators authorized by Maxxon Corporation.
- 5.3 For the floor coverings specified in Section 4.1, compliance with the applicable requirements of IBC Section 804 is outside the scope of this report.
- 5.4 Use of Maxxon underlayments as components of fire classified roof coverings is outside the scope of this report.

6.0 EVIDENCE SUBMITTED

- 6.1 Product literature and quality documentation.
- 6.2 Report of fire resistance testing, and engineering analysis based on physical properties of the gypsum concrete underlayments.
- 6.3 Reports of sound transmission testing in accordance with ASTM E492, ASTM E90, ASTM E1007, and ASTM E336; and engineering analysis.
- 6.4 Reports of density and compressive strength testing.

7.0 IDENTIFICATION

- 7.1 The bags of underlayment mix are identified with the Maxxon Corporation name, the product name, the manufacturing plant identifier, the date of manufacture, and the evaluation report number (ESR-2540).
- 7.2 The report holder's contact information is the following:

MAXXON CORPORATION
920 HAMEL ROAD
HAMEL, MINNESOTA 55340
(763) 478-9600
www.maxxoncorporation.com

TABLE 1—MINIMUM UNDERLAYMENT DEPTH OVER SOUND MAT¹

| SOUND MAT MATERIALS | MINIMUM UNDERLAYMENT DEPTH |
|--|---|
| Acousti-Mat® I | 3/4" |
| Acousti-Mat® II (including HP) | 1" |
| Acousti-Mat® 3 (including HP) (w/ optional reinforcement) | 1 1/2" |
| Enkasonic® 9110 (including HP) | 1" |
| Acousti-Mat® SD (w/ optional reinforcement) | 1 1/2" |
| Acousti-Mat® LP | 3/4" |
| Acousti-Mat® LPR | 3/4" |
| Where no sound mat is installed, minimum depth of underlayment must be as follows: | 3/4" over wood, 1" over steel, 3/8" over precast concrete |

¹For SI: 1 inch = 25.4 mm.

TABLE 2—ABBREVIATIONS USED IN ASSEMBLY DESCRIPTIONS

| ABBREVIATION | FLOOR TOPPING TYPE | ABBREVIATION | FLOOR TOPPING TYPE |
|--------------|---------------------|--------------|--------------------|
| GC | Gyp-Crete | RFP | Rapid Floor Plus |
| GC 2000 | Gyp-Crete 2000/3.2k | RFU | Rapid Floor Ultra |
| T-F | Therma-Floor | RFR | Rapid Radiant |
| D-C | Dura-Cap | L-R | Level Right |
| Ortecrete | Ortecrete | DCM | Dek C-Ment |
| RF | Rapid Floor | CT | Commercial Topping |

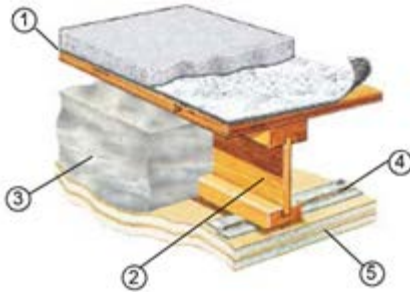

1. Flooring system.
 - a. Subflooring topped with Maxxon Corp Type D-C, GC, GC 2000, L-R, T-F, CT, DCM, or Rapid Floor Systems Type RF, RFP, RFU, RFR, or Ortecrete floor topping mixture with optional metal lath, Maxxon Corp Crack Suppression Mat (CSM) or Maxxon Reinforcement, and floor mat options as follows:
 - i. Maxxon Floor Primer and Maxxon Corp Acousti-Mat I or Acousti-Mat II.
 - ii. Maxxon Floor Primer and Acousti-Mat 3 with optional CSM, MR, or metal lath.
 - iii. Maxxon Floor Primer and Maxxon Corp Enkasonic 9110.
 - iv. Maxxon Corp Acousti-Mat LPR. Maxxon Floor Primer optional.
2. I-Joists.
3. Insulation.
4. Resilient channels.
5. Gypsum board.
6. Finish system (not shown).

FIGURE 1—SOUND RATED ASSEMBLY INCORPORATING I-JOISTS



1. Flooring system.
 - a. Subflooring topped with Maxxon Corp Type D-C, GC, GC 2000, L-R, T-F, CT, DCM, or Rapid Floor Systems Type RF, RFP, RFU, RFR, or Ortecrete floor topping mixture with optional metal lath, Maxxon Corp Crack Suppression Mat (CSM) or Maxxon Reinforcement (MR) and floor mat options as follows:
 - i. Maxxon Floor Primer and Maxxon Corp Acousti-Mat I or Acousti-Mat II.
 - ii. Maxxon Floor Primer and Acousti-Mat 3 with optional CSM, MR, or metal lath.
 - iii. Maxxon Floor Primer and Maxxon Corp Enkasonic 9110.
 - iv. Maxxon Corp Acousti-Mat LPR. Maxxon Floor Primer optional.
2. Trusses.
3. Insulation.
4. Resilient channels.
5. Gypsum board.
6. Finish system (not shown).

FIGURE 2—SOUND RATED ASSEMBLY INCORPORATING TRUSSES



1. Flooring system.
 - a. Subflooring topped with Maxxon Corp Type D-C, GC, GC 2000, L-R, T-F, CT, DCM, or Rapid Floor Systems Type RF, RFP, RFU, RFR, or Orcrete floor topping mixture with optional metal lath, Maxxon Corp Crack Suppression Mat (CSM), or Maxxon Reinforcement (MR) and floor mat options as follows:
 - i. Maxxon Floor Primer and Maxxon Corp Acousti-Mat I or Acousti-Mat II.
 - ii. Maxxon Floor Primer and Acousti-Mat 3 with optional CSM, MR, or metal lath.
 - iii. Maxxon Floor Primer and Maxxon Corp Enkasonic 9110.
 - iv. Maxxon Corp Acousti-Mat LPR. Maxxon Floor Primer optional.
2. Cross bridging (not shown).
3. Wood joists.
4. Insulation.
5. Resilient channels.
6. Gypsum board.
7. Battens (not shown).
8. Finish system (not shown).

FIGURE 3—SOUND RATED ASSEMBLY INCORPORATING WOOD JOISTS

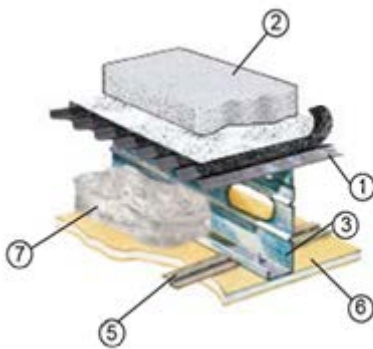

1. Steel deck.
2. Floor topping and floor mat. Maxxon Corp Type D-C, L-R, or CT; Maxxterior D-CM; Rapid Floor Systems RFU or Orcrete floor topping mixture over acrylic by Maxxon Corp and floor mat options as follows:
 - i. Maxxon Corp Acousti-Mat I, Acousti-Mat II, Acousti-Mat 3, or Enkasonic 9110.
 - ii. Maxxon Corp Acousti-Mat LPR.
 - iii. Maxxon Corp Acousti-Mat SD.
3. Steel joists.
4. Joist bridging (not shown).
5. Resilient channels.
6. Gypsum board.
7. Insulation.
8. Finish system (not shown).

FIGURE 4—SOUND RATED ASSEMBLY INCORPORATING STEEL JOISTS



1. Floor topping.
 - a. Maxxon Corp Type D-C, GC, GC 2000, L-R, T-F, CT, DCM or Rapid Floor Systems RF, RFP, RFU, RFR, or Orcrete floor topping mixture floor topping mixture with optional metal lath, Maxxon Corp Crack Suppression Mat (CSM), or Maxxon Reinforcement (MR) and floor mat options as follows:
 - i. Maxxon Floor Primer and Maxxon Corp Acousti-Mat I or Acousti-Mat II.
 - ii. Maxxon Floor Primer and Acousti-Mat 3 with optional CSM, MR, or metal lath.
 - iii. Maxxon Floor Primer and Maxxon Corp Enkasonic 9110.
 - iv. Maxxon Corp Acousti-Mat LPR. Maxxon Floor Primer optional.
2. Precast concrete units.
3. Grouted full length expansion joint.

FIGURE 5—SOUND RATED ASSEMBLY INCORPORATING PRECAST CONCRETE UNITS

**Fire Resistance Ratings - ANSI/UL 263
Unrestrained Assembly Rating — 1 Hr.**

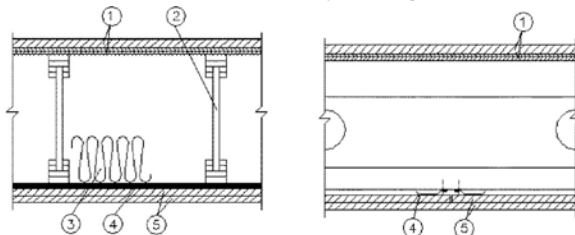

1. **Flooring System** — The flooring system shall consist of the following:

Subflooring — Min 19/32 in. thick T & G wood structural panels installed perpendicular to trusses with joints staggered 4 ft. Plywood or nonveneer

APA rated panels secured to trusses with construction adhesive and No. 6d ring shank nails spaced 12 in. OC along each truss. Staples having equal or greater withdrawal and lateral resistance strength may be substituted for the 6d nails.

Vapor Barrier - (Optional) — Nom 0.030 in. thick commercial asphalt saturated felt.

Floor Mat Materials* - (Optional) — Nom 1/4 in. thick floor mat material loose laid over the subfloor. Maxxon Floor Primer to be applied to the surface of the mat prior to the floor topping placement. When floor mat material is used, min thickness of floor topping mixture is 1 in. Floor topping thickness a min 3/4 in. over Acousti-Mat I floor mat.

MAXXON CORP — Type Acousti-Mat I, Acousti-Mat II, Acousti-Mat II HP.

Alternate Floor Mat Materials* — Nom 0.8 in. thick floor mat material loose laid over the subfloor with Crack Suppression Mat (CSM) loose laid over the floor mat material. Floor topping thickness shall be min 1-1/2 in.

MAXXON CORP — Type Acousti-Mat 3, Acousti-Mat 3 HP, Crack Suppression Mat (CSM), Maxxon Reinforcement (MR)

Metal Lath — (Alternate to Crack Suppression Mat (CSM)) — 3/8 in. expanded galvanized steel diamond mesh, 3.4 lbs/sq yd loose laid over the floor mat material. Floor topping thickness shall be min 1-1/2 in.

Alternate Floor Mat Materials* — Nom 0.4 in. thick floor mat material loose laid over the subfloor. Maxxon Floor Primer to be applied to the surface of the mat prior to the floor topping placement. Floor topping thickness shall be min 1 in.

MAXXON CORP — Type Enkasonic 9110, Enkasonic 9110 HP.

Metal Lath (Optional) — For use with floor mat materials, 3/8 in. expanded galvanized steel diamond mesh, 3.4 lbs/sq yd or Maxxon Corp. UL Classified Crack Suppression Mat (CSM) loose laid over the floor mat material. Floor topping thickness shall be min 1 in.

MAXXON CORP — Type Crack Suppression Mat (CSM), Maxxon Reinforcement (MR)

Fiber Glass Mesh Reinforcement — (Optional) — Maxxon Corp's "Maxxon Reinforcement (MR)" for use with or as an alternate to CSM or metal lath reinforcement, the materials consists of a plastic coated non-woven fiber glass mesh grid intended to suppress cracks in the Floor Topping Mixture.

Alternate Floor Mat Materials* — (Optional) — Nom 0.2 in. thick floor mat material loose laid over the subfloor. Maxxon Floor Primer may be applied to the surface of the mat prior to the floor topping placement. Floor topping thickness shall be as specified under Floor Topping Mixture.

MAXXON CORP — Type Acousti-Mat LP-R

Finish Flooring - Floor Topping Mixture* — Min 3/4 in. thickness of floor topping mixture depending upon floor mat system as specified above, having a min compressive strength of 1000 psi. Mixture shall consist of 3 to 7 gal of water to 80 lbs of floor topping mixture to 1.0 to 2.1 cu ft of sand.

MAXXON CORP — Type D-C, GC, GC2000, L-R, T-F, CT

Alternate Finish Flooring - Floor Topping Mixture* — Min 3/4 in. thickness of floor topping mixture depending upon floor mat system as specified above, having a min compressive strength of 1200 psi. Mixture shall consist of 4 to 7 gal of water to 80 lbs of floor topping mixture to 1.4 to 1.9 cu ft of sand.

RAPID FLOOR SYSTEMS — Type RF, RFP, RFU, RFR, Orcrete

2. Structural Wood Members* — Min 9-1/2 in. deep "I" shaped wood joists spaced at a max of 19.2 in. OC, and blocked at the ends using 2 in. by 10 in. wood members. Min joists bearing on plates shall be 5-1/2 in. Joists secured to the bearing plates with two 8d or 10d nails at each end. Spacing may be increased when **Batts and Blankets*** (Item 3B) is used.

WEYERHAEUSER NR — Types TJI® 360, TJI® 560, TJI®/L65, TJI®/L90, TJI®/H90, TJI®/HD90, TJI®/HS90, TJI® 100C, TJI® 300C .

3. Insulation - Batts and Blankets* — (Optional) — Glass fiber insulation, secured to the subflooring with staples, or to the wood joists with 0.090 in. diam galv steel wires, or draped over the resilient channel/gypsum panel (or Steel Framing Members/gypsum panel) ceiling membrane. Any thickness of glass fiber insulation bearing the UL Classification Marking as to Surface Burning Characteristics and/or Fire Resistance.

3A. Insulation - Loose Fill Material* — As an alternate to Item 3 — Any thickness of loose fill material bearing the UL Classification Marking for Surface Burning Characteristics, applied within the concealed space, over the resilient or furring channel/gypsum panel or Steel Framing Members/gypsum panel ceiling membrane.

3B. Insulation - Batts and Blankets* — (For Use When **Structural Wood Members*** are spaced 24 in OC) — Min. 1 in. thick glass fiber insulation bearing the UL Classification Marking as to Surface Burning Characteristics and/or Fire Resistance draped over the resilient channel/gypsum panel (or Steel Framing Members/gypsum panel) ceiling membrane.

4. Furring Channels — Resilient channels formed of 25 MSG thick galv steel. Installed perpendicular to the joists, spaced a max of 24 in. OC when no insulation is fitted in the concealed space, or 16 in. OC when insulation is fitted in the concealed space. Two courses of resilient channel positioned 6 in. OC at gypsum panel butt-joints (3 in. from each end of wallboard). Channels oriented opposite at gypsum panel butt-joints. Channel splices overlapped 4 in. beneath wood trusses. Channels secured to each truss with 1-1/4 in. long Type S screws.

5. Gypsum Board* — Two layers of 1/2 in. or 5/8 in. thick by 4 ft wide gypsum panels, installed perpendicular to resilient channels (Item 4). The base layer of panels screw-attached to the resilient channels with 1 in. long Type S screws spaced 8 in. OC at the butt joints and 16 in. OC in the field of the panel. The face layer screw-attached to the resilient channels with 1-5/8 in. Type S screws spaced 8 in. OC and 1-1/2 in. Type G screws spaced 8 in. OC at the butt joints located mid-span between resilient channels.

CGC INC — 1/2 in. Type C, IP-X2, IPC-AR; 5/8 in. Type C, SCX, IP-X1, IP-X2.

GEORGIA-PACIFIC GYPSUM L L C — Types 5, DAPC

UNITED STATES GYPSUM CO — 1/2 in. Type C, IP-X2, IPC-AR; 5/8 in. Type C, SCX, IP-X1, IP-X2.

USG MEXICO S A DE C V — 1/2 in. Type C, IP-X2, IPC-AR; 5/8 in. Type C, SCX, IP-X1, IP-X2.

6. Finishing System — Fiber tape embedded in compound over joints and exposed nail heads, covered with compound with edges of compound feathered out. As an alternate, nom 3/32 in. thick gypsum veneer plaster may be applied to the entire surface of classified veneer baseboard. Joints reinforced.

*Bearing the UL Classification Mark

FIGURE 6—1-HOUR FLOOR/CEILING ASSEMBLY INCORPORATING WOOD I-JOISTS

**Fire Resistance Ratings - ANSI/UL 263
Unrestrained Assembly Rating — 1 Hr.
Finish Rating — 24 or 25 Min (See Item 5)**

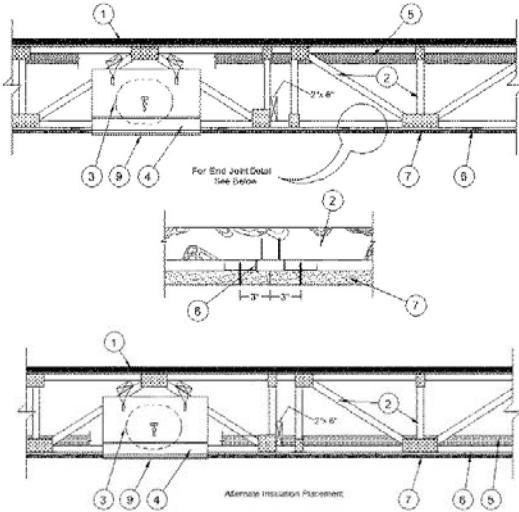

1. Flooring System — The flooring system shall consist of the following:

Subflooring — Min 15/32 or 19/32 in. thick wood structural panels, min grade "C-D" or "Sheathing". Face grain of plywood or strength axis of panel to be perpendicular to trusses with joints staggered.

Floor Mat Materials* - (Optional) — Nom 1/4 in. thick floor mat material loose laid over the subfloor. Maxxon Floor Primer to be applied to the surface of the mat prior to the floor topping placement. When floor mat material is used, min thickness of floor topping mixture is 1 in. Floor topping thickness a min 3/4 in. over Acousti-Mat I floor mat.

MAXXON CORP — Type Acousti-Mat I, Acousti-Mat II, Acousti-Mat II HP.

Alternate Floor Mat Materials* - (Optional) - Nom 0.8 in. thick floor mat material loose laid over the subfloor with Crack Suppression Mat (CSM) loose laid over the floor mat material. Floor topping thickness shall be min 1-1/2 in.

MAXXON CORP — Type Acousti-Mat 3, Acousti-Mat 3 HP, Crack Suppression Mat (CSM), Maxxon Reinforcement (MR)

Metal Lath (Alternate to Crack Suppression Mat (CSM)) - 3/8 in. expanded galvanized steel diamond mesh, 3.4 lbs/sq yd loose laid over the floor mat material. Floor topping thickness shall be min 1-1/2 in.

Alternate Floor Mat Materials* - (Optional) — Nom 0.4 in. thick floor mat material loose laid over the subfloor. Maxxon Floor Primer to be applied to the surface of the mat prior to the floor topping placement. Floor topping thickness shall be min 1 in.

MAXXON CORP — Type Enkasonic 9110, Enkasonic 9110 HP.

Metal Lath (Optional) — For use with floor mat materials, 3/8 in. expanded galvanized steel diamond mesh, 3.4 lbs/sq yd or Maxxon Corp. UL Classified Crack Suppression Mat (CSM) loose laid over the floor mat material. Floor topping thickness shall be min 1 in.

MAXXON CORP — Type Crack Suppression Mat (CSM), Maxxon Reinforcement (MR)

Fiber Glass Mesh Reinforcement — (Optional) — Maxxon Corp's "Maxxon Reinforcement (MR)" for use with or as an alternate to CSM or metal lath reinforcement, the materials consists of a plastic coated non-woven fiber glass mesh grid intended to suppress cracks in the Floor Topping Mixture.

Alternate Floor Mat Materials* - (Optional) — Nom 0.2 in. thick floor mat material loose laid over the subfloor. Maxxon Floor Primer may be applied to the surface of the mat prior to the floor topping

placement. Floor topping thickness shall be as specified under Floor Topping Mixture.

MAXXON CORP — Type Acousti-Mat LP-R

Finish Flooring - Floor Topping Mixture* — Min 3/4 or 1 in. thickness of floor topping mixture for min 19/32 or min 15/32 in. thick wood structural panels respectively, having a min compressive strength of 1000 psi. Mixture shall consist of 3 to 7 gal of water mixed with 80 lbs of floor topping mixture and 1.0 to 2.1 cu ft of sand.

MAXXON CORP — Types D-C, GC, GC 2000, L-R, T-F, CT

Alternate Finish Flooring - Floor Topping Mixture* — Min 3/4 or 1 in. thickness of floor topping mixture for min 19/32 or min 15/32 in. thick wood structural panels respectively, having a min compressive strength of 1200 psi. Mixture shall consist of 4 to 7 gal of water mixed with 80 lbs of floor topping mixture and 1.4 to 1.9 cu ft of sand.

RAPID FLOOR SYSTEMS — Types RF, RFP, RFU, RFR, Orcrete

Alternate Floor Mat Materials* - (Optional with Alternate Finish Flooring) — Nom 0.2 in. thick floor mat material loose laid over the subfloor. Maxxon Floor Primer may be applied to the surface of the mat prior to the floor topping placement. Floor topping thickness shall be as specified under **Floor Topping Mixture**.

MAXXON CORP — Type Acousti-Mat LP-R

2. Trusses — Parallel chord trusses spaced a max of 24 in. OC fabricated from nom 2 by 4 lumber, with lumber oriented vertically or horizontally. Min truss depth is 18 in. Min truss depth is 12 in. when used with Item 7C and Item 4, 4A and 4B are not employed. Truss members secured together with min 0.036 in. thick galv steel plates. Plates have 5/16 in. long teeth projecting perpendicular to the plane of the plate. The teeth are in pairs facing each other (made by the same punch), forming a split tooth type plate. Each tooth has a chisel point on its outside edge with these points being diagonally opposite each other for each pair. The top half of each tooth has a twist for stiffness. The pairs are repeated on approximately 7/8 in. centers with four rows of teeth per inch of plate width.

3. Air Duct* (Optional) — Any UL Class 0 or Class 1 flexible air duct installed in accordance with the instructions provided by the damper manufacturer

4. Ceiling Damper* - (Optional. To be used with Air Duct Item 3.) — For use with min 18 in. deep trusses. Max nom area shall be 324 sq in. Max square size shall be 18 in. by 18 in. Rectangular sizes not to exceed 324 sq in. with a max width of 18 in. Max height of damper shall be 14 in. Aggregate damper openings shall not exceed 162 sq in. per 100 sq ft of ceiling area. Damper installed in accordance with the manufacturers installation instructions provided with the damper. A steel grille (Item 9) shall be installed in accordance with installation instructions.

C&S AIR PRODUCTS — Model RD-521

POTTORFF — Model CFD-521

4A. Alternate Ceiling Damper* — Max nom area shall be 196 sq in. Max square size shall be 14 in. by 14 in. Rectangular sizes not to exceed 196 sq in. with a max width of 26 in. Max height of damper shall be 7 in. Aggregate damper openings shall not exceed 98 sq in. per 100 sq ft of ceiling area. Damper installed in accordance with the manufacturers installation instructions provided with the damper. A steel grille (Item 9) not to exceed 144 in.² shall be installed in accordance with installation instructions.

C&S AIR PRODUCTS — Model RD-521-BT

POTTORFF — Model CFD-521-BT.

4B. Alternate Ceiling Damper* — For use with min. 18 in. deep trusses. Max. nom area shall be 349 sq in. Max. overall length and width shall not exceed 18-11/16 in. by 18-11/16 in. with max. 16 in. by 16 in. register opening. Aggregate damper openings shall not exceed 175 sq in. per 100 sq ft of ceiling area. Damper installed in accordance with the manufacturers installation instructions provided with the damper. An aluminum or steel grille (Item 9) shall be installed in accordance with installation instructions.

MIAMI TECH INC — Model Series RxCRD, RxCRDS or RxCRPD

5. Batts and Blankets* - (Optional With Items 7 and 7B; Required With Item 7A) — Glass fiber or mineral wool insulation

bearing the UL Classification Marking as to Surface Burning Characteristics and/or Fire Resistance. When the resilient channels (Item 6) or furring channels (Item 6A) are spaced 16 in. OC, the insulation shall be a max of 3-1/2 in. thick, and shall be secured against the subflooring with staples at 12 in. OC or held suspended in the concealed space with 0.090 in. diam galv steel wires attached to the wood trusses at 12 in. OC. When the resilient channels (Item 6) or furring channels (Item 6A) are spaced a max of 12 in. OC or when the Steel Framing Members (Item 6B) are used, there is no limit in the overall thickness of insulation, and the insulation can be secured against the subflooring, held suspended in the concealed space or draped over the resilient or furring channels (or Steel Framing Members) and gypsum panel membrane. When **Steel Framing Members** (Item 6C) are used, max 3-1/2 in. thick insulation shall be draped over the furring channels (Item 6Ca) and gypsum board ceiling membrane, and friction-fitted between trusses and Steel Framing Members (Item 6Cd). The finished rating has only been determined when the insulation is secured to the subflooring.

5A. Fiber, Sprayed* — (Dry Dense Packed 100% Borate Formulation) — As an alternate to Item 5 — When used, the resilient channel and gypsum board attachment is modified as specified in Items 6 and 7 and wire mesh (Item 10) shall be attached to the furring channels to facilitate installation of the material. The finished rating when Fiber, Sprayed is used has not been determined. The fiber is applied without water or adhesive at a nominal dry density of 3.5 lb/ft³, in accordance with the application instructions supplied with the product. When Item 5A (Fiber, Sprayed) is used, two layers of gypsum board required as described in Item 7. Not evaluated for use with Item 6B, 6C or 6D.

U S GREENFIBER L L C — INS735, INS745, INS765LD & INS770LD to be used with dry application only.

5B. Fiber, Sprayed* — (Loose Fill 100% Borate Formulation) — As an alternate to Items 5 and 5A — The finished rating when Fiber, Sprayed is used has not been determined. The fiber is applied without water or adhesive at a minimum dry density of 0.5 lb/ft³ and at a max thickness of 3-1/2 in., in accordance with the application instructions supplied with the product. Wire mesh (Item 10) shall be attached to the furring channels to facilitate installation of the material. When Item 5B (Fiber, Sprayed) is used, two layers of gypsum board required as described in Item 7. Not evaluated for use with Item 6B, 6C or 6D.

U S GREENFIBER L L C — INS735, INS745, INS765LD & INS770LD to be used with dry application only.

6. Furring Channels — Resilient channels, formed of 25 MSG thick galv steel, spaced 16 in. OC perpendicular to trusses. When insulation (Items 5, 5A, 5B) is draped over the resilient channel/gypsum board ceiling membrane, the spacing shall be reduced to 12 in. OC. Channels secured to each truss with 1-1/4 in. long Type S bugle head steel screws. Channels overlapped 4 in. at splices. Two channels, spaced 6 in OC, oriented opposite each gypsum board end joint as shown in the above illustration. Additional channels shall extend 6 in beyond each side edge of board.

7. Gypsum Board* — Nom 5/8 in. thick, 48 in. wide gypsum board. When resilient channels (Item 6) are used, gypsum board installed with long dimension perpendicular to resilient channels. Gypsum board secured with 1 in. long Type S bugle head screws spaced 12 in. OC and located a min of 1/2 in. from side joints and 3 in. from end joints. End joints secured to both resilient channels as shown in end joint detail. When batt insulation (Item 5) is draped over the resilient channel/gypsum board ceiling membrane, screws spacing shall be 8 in. OC.

AMERICAN GYPSUM CO — Type AG-C
CGC INC — Types C, IP-X2, IPC-AR

GEORGIA-PACIFIC GYPSUM L L C — Types 5, DAPC.
UNITED STATES GYPSUM CO — Types C, IP-X2, IPC-AR
USG MEXICO S A DE C V — Types C, IP-X2, IPC-AR

7A. Gypsum Board* — Nom 5/8 in. thick, 48 in. wide gypsum board, installed with long dimension perpendicular to resilient channels. Gypsum board secured with 1-1/8 in. long Type S bugle head screws spaced 8 in. OC and located a min of 1/2 in. from side joints and 3 in. from the end joints. End joints secured to both resilient channels as shown in end joint detail. When Item 7A is used, the insulation must be used and must be draped over the resilient channel/gypsum board.

NATIONAL GYPSUM CO — Types FSW-G, FSW-C, FSK-G, FSK-C

7B. Gypsum Board* — Nom 5/8 in. thick, 48 in. wide gypsum board, installed with long dimension perpendicular to resilient channels. Gypsum board secured with 1-1/8 in. long Type S bugle head screws spaced 12 in. OC and located a min of 5/8 in. from side joints and 3 in. from the end joints. End joints secured to both resilient channels as shown in end joint detail. When Item 5 is used, the insulation must be secured to the plywood subfloor.

LAFARGE NORTH AMERICA INC — Type LGFC-C/A

7C. Gypsum Board* — Nom 5/8 in. thick, 48 in. wide gypsum panels. When resilient channels (Item 6) are used, gypsum panels installed with long dimension perpendicular to resilient channels. Gypsum panels secured with 1 in. long Type S bugle head steel screws spaced 12 in. OC and located a min of 1/2 in. from side joints and 3 in. from the end joints. When insulation (Items 5 or 5A) is applied over the resilient channel/gypsum panel ceiling membrane screw spacing shall be reduced to 8 in. OC. End joints secured to both resilient channels as shown in end joint detail. When **Fiber, Sprayed** (Items 5A or 5B) is used, two layers of nom 5/8 in. thick, 4 ft wide gypsum board are installed with long dimensions perpendicular to furring channels. Base layer gypsum board secured with 1 in. long Type S bugle head steel screws spaced 12 in. OC and located a min of 1/2 in. from side joints and 3 in. from the end joints. End joints secured to both resilient channels as shown in end joint detail. Outer layer gypsum board secured with 1-5/8 in. long Type S bugle head steel screws spaced 12 in. OC and located a min of 1/2 in. from side joints and 3 in. from the end joints. Outer layer shall be finished as described in Item 8.

CGC INC — Types C, IP-X2, IPC-AR

GEORGIA-PACIFIC GYPSUM L L C — Types 5, DAPC.
UNITED STATES GYPSUM CO — Types C, IP-X2, IPC-AR
USG MEXICO S A DE C V — Types C, IP-X2, IPC-AR

8. Finishing System - (Not Shown) — Vinyl, dry or premixed joint compound, applied in two coats to joints and screw-heads. Nom 2 in. wide paper tape embedded in first layer of compound over all joints. As an alternate, nom 3/32 in. thick veneer plaster may be applied to the entire surface of gypsum board.

9. Grille — Steel grille, installed in accordance with the installation instructions provided with the ceiling damper.

10. Wire Mesh — (Not shown) — For use with Item 5A and 5B — 1 in. 20 gauge galvanized poultry netting installed between the furring channels and gypsum board. The poultry netting is attached with washers and 1/2 in. wafer head screws, spaced 24 in. OC., to the furring channels. The **Fiber, Sprayed** (Item 5A or 5B) is installed through cut-openings in the poultry netting, in-between trusses. The cut-openings in the poultry netting shall be staggered at a maximum of 6 ft.

*Bearing the UL Classification Mark

FIGURE 7—1-HOUR FLOOR/CEILING ASSEMBLY INCORPORATING WOOD TRUSSES

Fire Resistance Ratings - ANSI/UL 263 Unrestrained Assembly Rating — 1 Hr

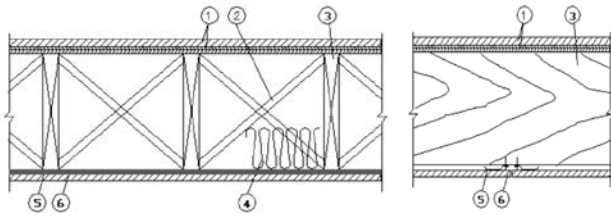

1. **Flooring System** — The flooring system shall consist of one of the following:

Subflooring — Nom 15/32 in. thick wood structural panels installed perpendicular to the joists with end joints staggered. Plywood or panels secured to joists with construction adhesive and No. 6d ringed shank nails, spaced 12 in. OC along each joist. Staples having equal or greater withdrawal and lateral resistance strength may be substituted for the 6d nails.

Vapor Barrier - (Optional) — Nom 0.030 in thick commercial asphalt saturated felt.

Floor Mat Materials* - (Optional) — Nom 1/4 in. thick floor mat material loose laid over the subfloor. Maxxon Floor Primer to be applied to the surface of the mat prior to the floor topping placement. When floor mat material is used, min thickness of floor topping mixture is 1 in. Floor topping thickness a min 3/4 in. over Acousti-Mat I floor mat.

MAXXON CORP — Type Acousti-Mat I, Acousti-Mat II, Acousti-Mat II HP.

Alternate Floor Mat Materials* - (Optional) — Nom 0.8 in. thick floor mat material loose laid over the subfloor with Crack Suppression Mat (CSM) loose laid over the floor mat material. Floor topping thickness shall be min 1-1/2 in.

MAXXON CORP — Type Acousti-Mat 3, Acousti-Mat 3 HP, Crack Suppression Mat (CSM), Maxxon Reinforcement (MR)

Metal Lath (Alternate to Crack Suppression Mat (CSM)) — 3/8 in. expanded galvanized steel diamond mesh, 3.4 lbs/sq yd loose laid over the floor mat material. Floor topping thickness shall be min 1-1/2 in.

Alternate Floor Mat Materials* - (Optional) — Nom 0.4 in. thick floor mat material loose laid over the subfloor. Maxxon Floor Primer to be applied to the surface of the mat prior to the floor topping placement. Floor topping thickness shall be min 1 in.

MAXXON CORP — Type Enkasonic 9110, Enkasonic 9110 HP.

Metal Lath (Optional) — For use with floor mat materials, 3/8 in. expanded galvanized steel diamond mesh, 3.4 lbs/sq yd or Maxxon Corp. UL Classified Crack Suppression Mat (CSM) loose laid over the floor mat material. Floor topping thickness shall be min 1 in.

MAXXON CORP — Type Crack Suppression Mat (CSM), Maxxon Reinforcement (MR)

Fiber Glass Mesh Reinforcement — (Optional) — Maxxon Corp's "Maxxon Reinforcement (MR)" for use with or as an alternate to CSM or metal lath reinforcement, the materials consists of a plastic coated non-woven fiber glass mesh grid intended to suppress cracks in the Floor Topping Mixture.

Alternate Floor Mat Materials* — (Optional) — Nom 0.2 in. thick floor mat material loose laid over the subfloor. Maxxon Floor Primer may be applied to the surface of the mat prior to the floor topping placement. Floor topping thickness shall be as specified under Floor Topping Mixture.

MAXXON CORP — Type Acousti-Mat LP-R

Finish Flooring - Floor Topping Mixture* — Min 3/4 in. thickness of floor topping mixture having a min compressive strength of 1000 psi. Mixture shall consist of 3 to 7 gal of water to 80 lbs of floor topping mixture to 1.0 to 2.1 cu ft of sand.

MAXXON CORP — Types D-C, GC, GC 2000, L-R, T-F, CT

Alternate Finish Flooring - Floor Topping Mixture* - Min 3/4 in. thickness of floor topping mixture having a min compressive strength of 1200 psi. Mixture shall consist of 4 to 7 gal of water to 80 lbs of floor topping mixture to 1.4 to 1.9 cu ft of sand.

RAPID FLOOR SYSTEMS — Type RF, RFP, RFU, RFR, Ortecrete

2. **Cross Bridging** — 1 by 3 in.

3. **Wood Joists** — 2 by 10 in., spaced 16 in. OC, firestopped. Spacing may increased to 24 in. OC when Item 7, Battens, are used.

4. **Batts and Blankets*** — (Optional) — Glass fiber or mineral wool insulation bearing the UL Classification Marking as to Surface Burning Characteristics and/or Fire Resistance. - When the resilient channels (Item 5) are spaced 16 in. OC, the insulation shall be a max of 3-1/2 in. thick, and shall be secured against the subflooring with staples at 12 in. OC or held suspended in the concealed space with 0.090 in. diam galv steel wires attached to the wood trusses at 12 in. OC. When the resilient channels (Item 5) are spaced a max of 12 in. OC, there is no limit in the overall thickness of insulation, and the insulation can be secured against the subflooring, held suspended in the concealed space or draped over the resilient channels and gypsum panel membrane.

4A. **Loose Fill Material*** — As an alternate to Item 5, when the resilient channels (Item 5) are spaced a max of 12 in. OC - Any loose fill material bearing the UL Classification Marking for Surface Burning Characteristics. There is no limit in the overall thickness of insulation.

5. **Resilient Channels** — Nom 1/2 in. deep by 2-3/8 in. wide at the base and 1-3/8 in. wide at the face, formed from 0.020 in. thick galv steel. Installed perpendicular to the wood joists, spaced a max of 24 in. OC when no insulation is fitted in the concealed space. Otherwise, the spacing shall be as specified under Item 4 or 4A. Two courses of resilient channel positioned 6 in. OC at gypsum panel butt-joints (3 in. from each end of panel). Channels oriented opposite at panel butt-joints. Channel splices overlapped 4 in. beneath wood trusses. Channels secured to each truss with 1-1/4 in. long Type S screws.

6. **Gypsum Board*** — Nom 5/8 in. thick, 48 in. wide gypsum panels. When resilient channels (Items 5) are used, gypsum panels installed with long dimension perpendicular to resilient channels. Gypsum panels secured with 1 in. long Type S bugle head steel screws spaced 12 in. OC and located a min of 1/2 in. from side joints and 3 in. from end joints. End joints secured to both resilient channels as shown in end joint detail. **CGC INC** — Types C, IP-X2, IPC-AR.

GEORGIA-PACIFIC GYPSUM L L C — Types 5, DAPC

UNITED STATES GYPSUM CO — Types C, IP-X2, IPC-AR.

USG MEXICO S A DE C V — Types C, IP-X2, IPC-AR.

7. **Battens** — Nom 6 by 22-1/2 by 5/8 in. thick pieces of gypsum board (Item 6) centered under subfloor joints and fastened with staples spaced 7 in. OC along each edge. Staples formed of 16 SWG (0.062 in. thick) steel with 1-1/8 in. legs and 1/2 in. crown, driven flush with gypsum board batten strips. The battens and staples are optional when the finish flooring consists of **Floor Topping Mixture***.

8. **Finishing System** — (Not shown) - Vinyl, dry or premixed joint compound, applied in two coats to joints and screw-heads. Nom 2 in. wide paper tape embedded in first layer of compound over all joints. As an alternate, nom 3/32 in. thick veneer plaster may be applied to the entire surface of gypsum panels.

*Bearing the UL Classification Mark

FIGURE 8—1-HOUR FLOOR/CEILING ASSEMBLY INCORPORATING WOOD JOISTS

Fire Resistance Ratings - ANSI/UL 263 Unrestrained Assembly Rating — 1 or 2 Hr.

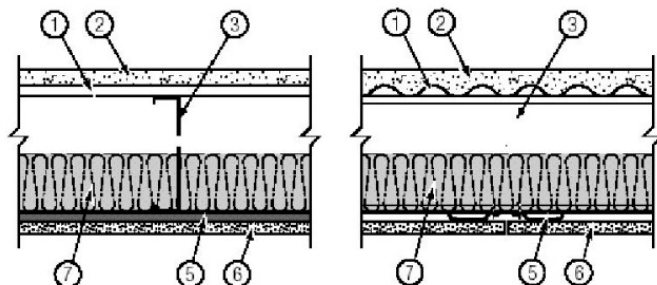

1. Steel Deck — Min 9/16 in. deep, 22 MSG galv corrugated fluted steel deck. Overlapped one corrugation at each side and attached to each joist with 3/4 in. long #10-16 TEK screws 10 in OC max.

2. Floor Topping Mixture* — Compressive strength to be 3000 psi min. Minimum thickness to be 1 in. as measured from the top plane of the deck or the top plane of the Floor Mat Material*. Refer to manufacturer's instructions accompanying the material for specific mix design. An acrylic provided by the floor-topping manufacturer shall be applied to the steel deck prior to the installation of the floor topping mixture at a maximum application rate of 300 ft²/gallon. Minimum 1-1/2 in. thickness as measured from the top of the mat, to be applied, when Acousti-Mat SD is used.

MAXXON CORP — Types D-C, L-R, CT

MAXXEXTERIOR L L C — Type D-CM

RAPID FLOOR SYSTEMS — Types RFU, Orcretec

2A. Floor Mat Materials* — (Optional) - Not Shown - Min 0.25 in. to max 0.8 in. thick floor mat material loose laid over the crests of the steel deck. Flutes of the steel deck to be filled with Floor Topping Mixture* prior to the application of the Floor Mat Materials*. Minimum 1 in. with Acousti-Mat I.

MAXXON CORP — Acousti-Mat I, Acousti-Mat II, Acousti-Mat II HP, Acousti-Mat 3, Acousti-Mat 3 HP, Enkasonic 9110, Enkasonic 9110 HP.

Alternate Floor Mat Materials* - (Optional) - Not Shown — Nom 0.2 in. thick floor mat material loose laid over the crests of the steel deck. Flutes of the steel deck to be filled with Floor Topping Mixture* prior to the application of the Floor Mat Materials*.

MAXXON CORP — Type Acousti-Mat LP-R

Alternate Floor Mat Materials* - (Optional) - Not Shown — Nom 0.80 in. thick floor mat material loose laid over the crests of the steel deck. Minimum 1-1/2 in thick floor topping mixture applied over the floor mat.

MAXXON CORP — Type Acousti-Mat SD

3. Steel Joists — C-shaped, galvanized steel sections, 9-1/4 in. min depth with 1-7/8 in. min. flanges and 1/2 in. min. stiffening flanges. The web of each joist may be provided with maximum 6-1/4 in. high by 9 in. long oval knockouts at the joist mid-depth. Knockouts spaced 48 in. OC minimum. The minimum coated steel thickness shall be 0.055 in. The minimum yield strength of the steel shall be 50 ksi. Joists spaced max 24 in. OC. Joists attached to joist rim with three 3/4 in. long self-drilling #10-16 TEK screws through tab to the outside of the web. At joist rim splices bearing on supports, joist rims are connected using an overlapping section of a 12 in. long splice plate (a joist piece), with four 3/4 in. long self-drilling #10-16 TEK screws to each rim piece.

3A. Steel Joists — As an alternate to Item 3 - C shaped galvanized steel sections with min 8 in. deep, min 1-9/16 in. flanges and min 3/8 in. min. stiffening flanges, fabricated from min No. 16 MSG galv steel with a min yield strength of 33 ksi. When the clear span is a max of 8 ft and when fabricated from min No. 18 MSG, the min depth is 6 in. The web of each joist may be provided with circular or oval knockouts at the joist mid-depth. Knockouts spaced min 48 in. OC. Joists spaced max 24 in. OC. Joists attached to joist rim with three 3/4 in. long self-drilling #10-16 TEK screws through tab to the outside of the web. At joist rim splices bearing on supports, joist rims are connected using an overlapping section of a 12 in. long splice plate (a joist piece), with four 3/4 in. long self-drilling #10-16 TEK screws to each rim piece.

4. Joist Bridging — Not shown — Installed immediately after joists are erected and before construction loads are applied. The bridging consists of min 1-1/4 in. deep, 2-3/4 in. wide and 21-3/4 in. long, formed galvanized steel installed in a staggered formation a maximum of every 8' along the joist span. Bridging secured to joist bottom flange with one 3/4 in. long self-drilling #10-16 TEK screw at each end tab. Minimum coated steel thickness for bridging is 0.048 in. Solid blocking must be provided in the two end joist bays and a maximum of 8 ft. OC (every 4 joist spaces). Solid blocking consisting of cut to length joist sections secured to the joists with clips. Clips are min 4 in. by 1-1/2 in. by 7 in. long, 0.054 in. thick, 50 ksi yield strength and secured with two 3/4 in. long self-drilling #10-16 TEK screws per leg.

5. Resilient Channels — 1/2 in. deep, 2-1/4 in. wide formed of 26 MSG galv steel with a 1 in. fastening surface, spaced 12 in. OC perpendicular to joists. Channel splices overlapped 5 in. beneath steel joists. Channels secured to each joist with 1/2 in. Type S-12 pan head screws. Channels oriented opposite at wallboard butt joints (spaced 6 in. OC) as shown in the above illustration.

5A. Alternate Steel Framing Members — (Not Shown) - **For 1 Hr Rating Only.** - As an alternate to Item 5, main runners, cross tees, cross channels and wall angle as listed below:

a. **Main Runners** — Nom 10 or 12 ft long, 15/16 in. or 1-1/2 in. wide face, spaced 4 ft. OC. Main runners suspended by min 12 SWG galv steel hanger wires spaced 48 in. OC. Hanger wires to be located adjacent to main runner/cross tee intersections. Hanger wires inserted through holes drilled through web of joists and twist-tied.

b. **Cross Tees** — Nom 4 ft long, 1-1/2 in. wide face, installed perpendicular to the main runners, spaced 16 in. OC. Additional cross tees or cross channels used at 8 in. from each side of butted gypsum panel end joints. The cross tees or cross channels may be riveted or screw attached to the wall angle or channel to facilitate the ceiling installation.

c. **Cross Channels** — Nom 4 or 12 ft long, installed perpendicular to main runners, spaced 16 in. OC.

d. **Wall Angle or Channel** — Painted or galv steel angle with 1 in. legs or channel with 1 in. legs, 1-9/16 in. deep attached to walls at perimeter of ceiling with fasteners 16 in. OC. To support steel framing member ends and for screw-attachment of the gypsum panel.

CGC INC — Type DGL or RX.

USG INTERIORS LLC — Type DGL or RX.

5B. Alternate Steel Framing Members — (Not Shown) - As an alternate to Item 5, main runners, cross tees, and wall angle as listed below. Steel framing members shall be suspended min 5 in. below bottom of structural steel members. :

a. **Main Runners** — Nom 12 ft long, spaced 4 ft. OC. Main runners suspended by min 12 SWG galv steel hanger wires spaced 32 in. OC. Hanger wires to be located adjacent to main runner/cross tee intersections. Hanger wires inserted through holes drilled through web of joists and twist-tied. The main runners may be riveted or screw-attached to the wall angle or channel to facilitate the ceiling installation.

b. **Cross Tees** — Nom 4 ft long, installed perpendicular to the main runners, spaced 16 in. OC. Additional cross tee required at each gypsum board end joint with butted end joint centered between cross tees spaced 8 in. OC. The cross tees may be riveted or screw attached to the wall angle or channel to facilitate the ceiling installation.

c. **Wall Angle or Channel** — Painted or galv steel angle with 1 in. legs or channel with 1 in. legs, 1-9/16 in. deep attached to walls at perimeter of ceiling with fasteners 16 in. OC. To support steel framing member ends and for screw-attachment of the gypsum panel.

ARMSTRONG WORLD INDUSTRIES INC — Type DFR-8000

6. Gypsum Board* — Nom 5/8 in. thick, 48 in. wide gypsum panels installed with long dimension perpendicular to resilient channels and side joints centered between joints. Gypsum panels secured with 1 in. long Type S bugle-head screws. Screws provided 1-1/2 and 4 in. and from side edges of the board 8 in. OC in the field.

CGC INC — Types C, IP-X2, IPC-AR

GEORGIA-PACIFIC GYPSUM L L C — Types 5, DAPC

NATIONAL GYPSUM CO — Type FSW-C, FSK-C

UNITED STATES GYPSUM CO — Type C, IP-X2, IPC-AR

USG MEXICO S A DE C V — Types C, IP-X2, IPC-AR

6A. Gypsum Board* — When Steel Framing Members (Item 5A) are used. Nom 5/8 in. thick, 48 in. wide gypsum panels installed with long dimension perpendicular to cross tees with side joints centered along main runners and end joints centered along cross tees. Panels fastened to cross tees with 1 in long Typs S bugle-head screws spaced 8 in. OC in the field and along end joints. Panels fastened to main runners with 1 in. long Type S bugle-head screws spaced midway between cross tees. Screws along sides and ends of panels spaced 3/8 to 1/2 in. from panel edge. End joints of panels shall be staggered with spacing between joints on adjacent panels not less than 2 ft OC.

CGC INC — Types C, IP-X2, IPC-AR

GEORGIA-PACIFIC GYPSUM L L C — Types 5, DAPC

NATIONAL GYPSUM CO — Type FSW-C, FSK-C

UNITED STATES GYPSUM CO — Types C, IP-X2, IPC-AR

USG MEXICO S A DE C V — Types C, IP-X2, IPC-AR

6B. Gypsum Board* — When Steel Framing Members (Item 5B) are used. Nom 5/8 in. thick, 48 in. wide gypsum panels installed with long dimension perpendicular to cross tees with side joints centered along main runners and end joints centered between cross tees spaced 8 in. OC. Prior to installation of the gypsum board sheets, backer strips consisting of nom 7-3/4 in. wide pieces of gypsum board are to be laid atop the cross tee flanges and centered over each butted end joint location. The backer strips are to be secured

to the flanges of the cross tees at opposite corners of the backer strip to prevent the backer strips from being uplifted during screw-attachment of the gypsum board sheets. Gypsum board fastened to cross tees with drywall screws spaced 1 in. and 4 in. from the side joints and max 8 in. OC in the field of the board. The butted end joints are to be secured to the backer strip with No. 10 by 1-1/2 in. long Type G laminating screws located 1 in. from each side of the butted end joint and spaced 1 in. and 4 in. from the side joints and max 8 in. OC in the field of the board.

CGC INC — Types C, IP-X2, IPC-AR

GEORGIA-PACIFIC GYPSUM L L C — Types 5, DAPC

NATIONAL GYPSUM CO — Type FSW-C, FSK-C

UNITED STATES GYPSUM CO — Types C, IP-X2, IPC-AR

USG MEXICO S A DE C V — Types C, IP-X2, IPC-AR

7. Batts and Blankets* — Mineral wool or glass fiber insulation, min 3-1/2 in. thick, bearing the UL Classification Marking for Surface Burning Characteristics. Insulation fitted in the concealed space, draped over the resilient channels.

8. Joint System — Not Shown — Vinyl, dry or premixed joint compound, applied in two coats to joints and screw heads; paper tape, 2 in. wide, embedded in first layer of compound over all joints.

*Bearing the UL Classification Mark

FIGURE 9—1-HOUR FLOOR/CEILING ASSEMBLY INCORPORATING STEEL JOISTS

Fire Resistance Ratings - ANSI/UL 263
Restrained Assembly Ratings — 2 Hr.
Unrestrained Assembly Rating — 1 1/2 Hr.

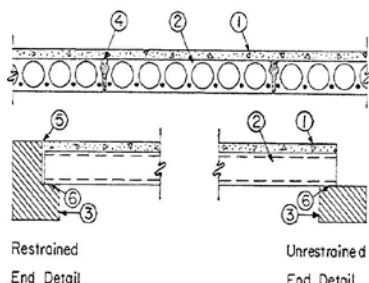

1. Finish Flooring-Floor Topping Mixture* — 3 to 7 gal of water mixed with 80 lbs of floor topping mixture and 1.0 to 2.1 cu ft of sand. Compressive strength to be 1000 psi min. Min thickness to be 3/4 in.

MAXXON CORP — Type D-C, GC, GC 2000, L-R, T-F, CT .

Or — 4 to 7 gal of water mixed with 80 lbs of floor topping mixture and 1.4 to 1.9 cu ft of sand. Compressive strength to be 1200 psi min. Min thickness to be 3/4 in.

RAPID FLOOR SYSTEMS — TYPE RF, RFP, RFU, RFR, Ortercrete

Floor Mat Materials* (Optional) — Floor mat material nom 1/4 in. thick loose laid over the subfloor. Maxxon Floor Primer to be applied to the surface of the mat prior to the floor topping placement. Floor topping thickness a min 1 in. over the floor mat. Floor topping thickness a min 3/4 in. over Acousti-Mat I floor mat.

MAXXON CORP — Type Acousti-Mat I, Acousti-Mat II, Acousti-Mat II HP.

Alternate Floor Mat Materials* - (Optional) — Nom 0.8 in. thick floor mat material loose laid over the subfloor with Crack Suppression Mat (CSM) loose laid over the floor mat material. Floor topping thickness shall be min 1-1/2 in.

MAXXON CORP — Type Acousti-Mat 3, Acousti-Mat 3 HP, Crack Suppression Mat (CSM), Maxxon Reinforcement (MR)

Metal Lath (Alternate to Crack Suppression Mat (CSM)) — 3/8 in. expanded galvanized steel diamond mesh, 3.4 lbs/sq yd loose laid over the floor mat material. Floor topping thickness shall be min 1-1/2 in.

Alternate Floor Mat Materials* - (Optional) — Nom 0.4 in. thick floor mat material loose laid over the subfloor. Maxxon Floor Primer

to be applied to the surface of the mat prior to the floor topping placement. Floor topping thickness shall be min 1 in.

MAXXON CORP — Type Enkasonic 9110, Enkasonic 9110 HP.

Metal Lath (Optional) — For use with floor mat materials, 3/8 in. expanded galvanized steel diamond mesh, 3.4 lbs/sq yd or Maxxon Corp. UL Classified Crack Suppression Mat (CSM) loose laid over the floor mat material. Floor topping thickness shall be min 1 in.

MAXXON CORP — Type Crack Suppression Mat (CSM), Maxxon Reinforcement (MR)

Fiber Glass Mesh Reinforcement — (Optional) — Maxxon Corp's "Maxxon Reinforcement (MR)" for use with or as an alternate to CSM or metal lath reinforcement, the materials consists of a plastic coated non-woven fiber glass mesh grid intended to suppress cracks in the Floor Topping Mixture.

Alternate Floor Mat Materials* (Optional) — Nom 0.2 in. thick floor mat material loose laid over the subfloor. Maxxon Floor Primer may be applied to the surface of the mat prior to the floor topping placement. Floor topping thickness shall be min 3/4 in.

MAXXON CORP — Type Acousti-Mat LP-R

2. Precast Concrete Units* — Nom 8, 10, 12 or 14 in. thick units. Normal weight aggregate. Cross section similar to the above illustration.

BOCCELLA PRECAST L L C

HOLLOWCORE INC

PRESTRESSED SLABS INC

SEQUATCHIE CONCRETE SERVICE INC

STRES CORE INC

3. End Details — Restrained and unrestrained.

4. Joint — Clearance between slabs at bottom, full length, 1/16 in. min., 5/16 in. max, grouted full length with sand-cement grout (3500 psi min compressive strength) to a max depth of 4 1/2 in. This depth may be maintained by placing a compressible material in the bottom of the joint before applying grout.

Note: — A 3/4-in. lateral expansion joint to be provided the full length and depth of the slabs every 14 ft. Expansion should be obtained with noncombustible, compressible material, for example, 24 sheets of 1/16 in. thick ceramic fiber paper (total thickness equals 1-1/2 in.).

5. End Clearance — Clearance for expansion at each end of slabs shall be equal to (3/16 +or- 1/16 in.) L/17 in., where "L" is equal to length of span in feet.

6. Min Bearing — 1-1/2 in.

*Bearing the UL Classification Mark

FIGURE 10—2-HOUR FLOOR/CEILING ASSEMBLY INCORPORATING PRECAST CONCRETE UNITS