

# ICC-ES Evaluation Report

**ESR-2582**

Reissued February 2024

This report also contains:

- LABC Supplement

Subject to renewal February 2025

- FBC Supplement

ICC-ES Evaluation Reports are not to be construed as representing aesthetics or any other attributes not specifically addressed, nor are they to be construed as an endorsement of the subject of the report or a recommendation for its use. There is no warranty by ICC Evaluation Service, LLC, express or implied, as to any finding or other matter in this report, or as to any product covered by the report.

Copyright © 2024 ICC Evaluation Service, LLC. All rights reserved.

<p><b>DIVISION: 03 00 00— CONCRETE</b></p> <p><b>Section: 03 16 00— Concrete Anchors</b></p> <p><b>DIVISION: 05 00 00— METALS</b></p> <p><b>Section: 05 05 19—Post- installed Concrete Anchors</b></p>	<p><b>REPORT HOLDER: DEWALT</b></p>	<p><b>EVALUATION SUBJECT: AC100+ GOLD® ADHESIVE ANCHOR SYSTEM IN CRACKED AND UNCRACKED CONCRETE (DEWALT)</b></p>	
--	---	--	---

## 1.0 EVALUATION SCOPE

### Compliance with the following codes:

- 2021, 2018, 2015, and 2012 [International Building Code® \(IBC\)](#)
- 2021, 2018, 2015, and 2012 [International Residential Code® \(IRC\)](#)

For evaluation for compliance with codes adopted by [Los Angeles Department of Building and Safety \(LADBS\)](#), see [ESR-2582 LABC and LARC Supplement](#).

For evaluation for compliance with the [National Building Code of Canada® \(NBCC\)](#), see listing report [ELC-2582](#).

### Property evaluated:

Structural

## 2.0 USES

The AC100+ Gold adhesive anchor system is used as anchorage in cracked and uncracked normal weight concrete or lightweight concrete having a specified compressive strength,  $f'_c$ , of 2,500 psi to 8,500 psi (17.2 MPa to 58.6 MPa) to resist static, wind, or earthquake (Seismic Design Categories A through F) tension and shear loads in  $1/2$ -,  $5/8$ -,  $3/4$ -,  $7/8$ -, 1- and  $1 1/4$ -inch-diameter (12.7, 15.9, 19.1, 22.2, 25.4 and 31.8 mm) threaded steel rods and No. 4 through No. 10 steel reinforcing bars; and used as anchorage in uncracked normal weight concrete only having a specified compressive strength,  $f'_c$ , of 2,500 psi to 8,500 psi (17.2 MPa to 58.6 MPa) to resist static, wind and earthquake (IBC Seismic Design Categories A and B only) tension and shear loads in  $3/8$ -inch-diameter (9.5 mm) threaded steel rods and No. 3 steel reinforcing bars in hammer-drilled holes.

The anchor system complies with anchors as described in Section 1901.3 of the 2021, 2018 and 2015 IBC, Section 1909 of the 2012 IBC and is an alternative to anchors described in Sections 1908 of the 2012 IBC. The anchor systems may also be used where an engineered design is submitted in accordance with Section R301.1.3 of the IRC.

## 3.0 DESCRIPTION

### 3.1 General:

The AC100+ Gold Adhesive is comprised of AC100+ Gold two-component adhesive filled in cartridges, static mixing nozzles, manual or powered dispensing tools, hole cleaning equipment, and adhesive injection accessories. The AC100+ Gold adhesive may be used with continuously threaded steel rods or deformed steel reinforcing bars.

Product names for the report holder is presented in the following table of this report.

Company Name	Adhesive Product Name
DEWALT	AC100+ Gold®
	AC100-PRO (outside the Americas)

The primary components of the AC100+ Gold Adhesive Anchor System, including the AC100+ Gold adhesive cartridge, static mixing nozzle, the nozzle extension tube and steel anchor elements, are shown in [Figure 3](#) of this report. Manufacturer's printed installation instructions (MPII) and parameters, included with each adhesive unit package, are shown in [Figure 4](#) of this report.

### 3.2 Materials:

**3.2.1 AC100+ Gold Adhesive:** The AC100+ Gold adhesive is an injectable two-component vinylester adhesive. The two components are kept separate by means of a labeled dual-cylinder cartridge. The two components combine and react when dispensed through a static mixing nozzle, supplied by DEWALT, which is attached to the cartridge. AC100+ Gold is available in: coaxial cartridges: 9.5-ounce (280 mL) and 14-ounce (420 mL), and side-by-side cartridges: 11.5-ounce (345 mL), and 28-ounce (825 mL). Each cartridge label is marked with the adhesive expiration date. The shelf life, as indicated by the expiration date, applies to an unopened cartridge stored in a dry, dark, and cool environment.

**3.2.2 Hole Cleaning Equipment:** Hole cleaning equipment is comprised of steel wire brushes supplied by DEWALT, and air blowers which are shown in [Figure 4](#) of this report.

**3.2.3 Dispensers:** AC100+ Gold adhesive must be dispensed with manual dispensers, pneumatic dispensers, or electric powered dispensers supplied by DEWALT.

#### 3.2.4 Steel Anchor Elements:

**3.2.4.1 Threaded Steel Rods:** Threaded steel rods must be clean and continuously threaded (all-thread) in diameters described in [Table 1](#) of this report. The embedded portions of the threaded rods must be clean, straight, and free of mill scale, rust and other coatings (other than zinc) that may impair the bond with the adhesive. Specifications for grades of threaded rod, including the mechanical properties, and corresponding nuts, are included in [Table 2](#). Carbon steel threaded rods may be furnished with a minimum 0.0002-inch-thick (0.005 mm) zinc electroplated coating complying with ASTM B633SC 1 or a minimum 0.0021-inch-thick (0.053 mm) mechanically deposited zinc coating complying with ASTM B695, Class 55; or hot dip galvanized zinc coating complying with ASTM A153, Class C or D. The stainless steel threaded rods must comply with [Table 2](#) of this report. Steel grades and types of material (carbon, stainless) for the washers and nuts must match the threaded rods. Threaded steel rods must be clean, straight and free of indentations or other defects along their length. The embedded end may be flat cut or cut on the bias to a chisel point.

**3.2.4.2 Steel Reinforcing Bars:** Steel reinforcing bars must be deformed reinforcing bars (rebar) in sizes as described in [Table 1](#) of this report. The embedded portions of reinforcing bars must be clean, straight, and free of mill scale, rust and other coatings (other than zinc) that may impair the bond with the adhesive. Reinforcing bars must not be bent after installation except as set forth in ACI 318-19 Section 26.6.3.2 (b), ACI 318-14 26.6.3.1 (b) or ACI 318-11 7.3.2, as applicable, with the additional condition that the bars must be bent cold, and heating of reinforcing bars to facilitate field bending is not permitted.

**3.2.4.3 Ductility:** In accordance with ACI 318 (-19 and -14) Section 2.3 or ACI 318-11 D.1, as applicable, in order for a steel anchor element to be considered ductile, the tested elongation must be at least 14 percent and reduction of area must be at least 30 percent. Steel elements with a tested elongation of less than 14 percent or a reduction of area less than 30 percent, or both, are considered brittle. Values for various steel materials are provided in [Table 2](#) of this report. Where values are nonconforming or unstated, the steel must be considered brittle.

### 3.3 Concrete:

Normal weight concrete and lightweight concrete must comply with Sections 1903 and 1905 of the IBC, as applicable. The specified compressive strength of the concrete must be from 2,500 psi to 8,500 psi (17.2 MPa to 58.6 MPa).

## 4.0 DESIGN AND INSTALLATION

### 4.1 Strength Design:

**General:** The design strength of anchors under the 2021 IBC, as well as the 2021 IRC must be determined in accordance with ACI 318-19 and this report. The design strength of anchors under the 2018 and 2015 IBC, as well as the 2018 and 2015 IRC, must be determined in accordance with ACI 318-14 and this report. The design strength of anchors under the 2012 IBC, as well as the 2012 IRC must be determined in accordance with ACI 318-11 and this report.

The strength design of anchors must comply with ACI 318-19 17.5.1.2, ACI 318-14 17.3.1 or ACI 318-11 D.4.1, as applicable, except as required in ACI 318-19 17.10, ACI 318-14 17.2.3 or ACI 318-11 D.3.3, as applicable.

Design parameters are provided in [Table 4](#) through [Table 8](#) of this report. Strength reduction factors,  $\phi$ , as given in ACI 318-19 17.5.3, ACI 318-14 17.3.3 or ACI 318-11 D.4.3, as applicable, must be used for load combinations calculated in accordance with Section 1605.1 of the 2021 IBC, Section 1605.2 of the 2018, 2015, and 2012 IBC, ACI 318 (-19 and -14) 5.3 or ACI 318-11 9.2, as applicable. Strength reduction factors,  $\phi$ , as described in ACI 318-11 D.4.4 must be used for load combinations calculated in accordance with ACI 318-11 Appendix C.

**4.1.1 Static Steel Strength in Tension:** The nominal static steel strength of a single anchor in tension,  $N_{sa}$ , in accordance with ACI 318-19 17.6.1.2, ACI 318-14 17.4.1.2 or ACI 318-11 D.5.1.2, as applicable, and the associated strength reduction factors,  $\phi$ , in accordance with ACI 318-19 17.5.3, ACI 318-14 17.3.3 or ACI 318-11 D.4.3, as applicable, are provided in [Table 4](#) and [Table 5](#) of this report for the anchor element types included in this report. See [Table 1](#) for design use and table index.

**4.1.2 Static Concrete Breakout Strength in Tension:** The nominal concrete breakout strength of a single anchor or group of anchors in tension,  $N_{cb}$  or  $N_{cbg}$ , must be calculated in accordance with ACI 318-19 17.6.2, ACI 318-14 17.4.2 or ACI 318-11 D.5.2, as applicable, with the following addition:

The basic concrete breakout strength of a single anchor in tension,  $N_b$ , must be calculated in accordance with ACI 318-19 17.6.2.2, ACI 318-14 17.4.2.2 or ACI 318-11 D.5.2.2, as applicable using the selected values of  $k_{c,cr}$  and  $k_{c,uncr}$  as provided in the tables of this report. Where analysis indicates no cracking in accordance with ACI 318-19 17.6.2.5, ACI 318-14 17.4.2.6 or ACI 318-11 D.5.2.6, as applicable,  $N_b$  must be calculated using  $k_{c,uncr}$  and  $\Psi_{c,N} = 1.0$ . See [Table 1](#) for additional design information. See ACI 318-19 17.2.4, ACI 318-14 17.2.6 or ACI 318-11 D.3.6, as applicable, for modification factor,  $\lambda_a$ , for lightweight concrete. The value of  $f'_c$  used for calculation must be limited to 8,000 psi (55 MPa) in accordance with ACI 318-19 17.3.1, ACI 318-14 17.2.7 or ACI 318-11 D.3.7, as applicable. Additional information for the determination of nominal bond strength in tension is given in Section 4.1.4 of this report.

**4.1.3 Static Bond Strength in Tension:** The nominal static bond strength of a single adhesive anchor or group of adhesive anchors in tension,  $N_a$  or  $N_{ag}$ , must be calculated in accordance with ACI 318-19 17.6.5, ACI 318-14 17.4.5 or ACI 318-11 D.5.5, as applicable. Bond strength values ( $\tau_{k,cr}$ ,  $\tau_{k,uncr}$ ) are a function of concrete compressive strength ( $f'_c$ ), concrete state (cracked, uncracked), and installation conditions (dry concrete, water-saturated concrete, water-filled holes). Bond strength values must further be modified with the factor  $K_{nn}$  for cases where the holes are water-filled at the time of anchor installation ( $K_{wf}$ ). Special inspection level is qualified as periodic for all anchors except as noted in Section 4.4 of this report. The selection of continuous special inspection level does not provide an increase in anchor category or associated strength reduction factors for design. The following table summarizes the requirements:

CONCRETE STATE	DRILLING METHOD	BOND STRENGTH	CONCRETE STRENGTH	PERMISSIBLE INSTALLATION CONDITIONS	ASSOCIATED STRENGTH REDUCTION FACTOR
Cracked and uncracked	Hammer-drill	$\tau_{k,cr}$ or $\tau_{k,uncr}$	$f'_c$	Dry concrete	$\phi_d$
				Water-saturated concrete	$\phi_{ws}$
				Water-filled hole (flooded)	$\phi_{wf}$

The bond strength values in [Table 7](#) and [Table 8](#) for hammer-drilled holes, correspond to concrete compressive strength  $f'_c$  equal to 2,500 psi (17.2 MPa) in normal weight concrete. For concrete compressive strength,  $f'_c$  between 2,500 psi and 8,000 psi (17.2 MPa and 55.2 MPa), the tabulated characteristic bond strength may be increased by a factor of  $(f'_c / 2,500)^{0.13}$  [For **SI**:  $(f'_c / 17.2)^{0.13}$ ]. Where applicable, the modified

bond strength values must be used in lieu of  $\tau_{k,cr}$  and  $\tau_{k,uncr}$  in ACI 318-19 Equations (17.6.5.1.2b) and (17.6.5.2.1), ACI 318-14 Equations (17.4.5.1d) and (17.4.5.2) or ACI 318-11 Equations (D-21) and (D-22), as applicable. The resulting nominal bond strength must be multiplied by the associated strength reduction factor  $\phi_d$ ,  $\phi_{ws}$  or  $\phi_{wf}$ , as applicable.

Figure 2 of this report presents a bond strength design selection flowchart. Strength reduction factors for determination of the bond strength are given in Table 7 and Table 8 of this report. See Table 1 for index of design tables. Adjustments to the bond strength may also be made for increased concrete compressive strength as noted above and in the footnotes to the corresponding tables. For anchors in lightweight concrete see ACI 318-19 17.2.4, ACI 318-14 17.2.6 or ACI 318-11 D.3.6, as applicable.

**4.1.4 Static Steel Strength in Shear:** The nominal static strength of a single anchor in shear, as governed by the steel,  $V_{sa}$ , in accordance with ACI 318-19 17.7.1.2, ACI 318-14 17.5.1.2 or ACI 318-11 D.6.1.2, as applicable, and the strength reduction factors,  $\phi$ , in accordance with ACI 318-19 17.5.3, ACI 318-14 17.3.3 or ACI 318-11 D.4.3, as applicable, are given in Table 4 and Table 5 of this report for the anchor element types included in this report. See Table 1 for index of design tables.

**4.1.5 Static Concrete Breakout Strength in Shear:** The nominal concrete breakout strength of a single anchor or group of anchors in shear,  $V_{cb}$  or  $V_{cbg}$ , must be calculated in accordance with ACI 318-19 17.7.2, ACI 318-14 17.5.2 or ACI 318-11 D.6.2, as applicable, based on information given in Table 6 of this report. The basic concrete breakout strength of a single anchor in shear,  $V_b$ , must be calculated in accordance with ACI 318-19 17.7.2.2, ACI 318-14 17.5.2.2 or ACI 318-11 D.6.2.2, as applicable, using the values of  $d$  given in Table 6 for the corresponding anchor steel in lieu of  $d_a$ . In addition,  $h_{ef}$  must be substituted for  $\ell_e$ . In no case must  $\ell_e$  exceed  $8d$ . See ACI 318-19 17.2.4, ACI 318-14 17.2.6 or ACI 318-11 D.3.6, as applicable, for modification factor,  $\lambda_a$ , for lightweight concrete. The value of  $f'_c$  must be limited to a maximum of 8,000 psi (55 MPa) in accordance with ACI 318-19 17.3.1, ACI 318-14 17.2.7 or D.3.7 ACI 318-11 D.3.7, as applicable.

**4.1.6 Static Concrete Pryout Strength in Shear:** The nominal static pryout strength of a single anchor or group of anchors in shear,  $V_{cp}$  or  $V_{cpg}$ , shall be calculated in accordance with ACI 318-19 17.7.3, ACI 318-14 17.5.3 or ACI 318-11 D.6.3, as applicable.

**4.1.7 Interaction of Tensile and Shear Forces:** For designs that include combined tension and shear, the interaction of tension and shear loads must be calculated in accordance with ACI 318-19 17.8, ACI 318-14 17.6 or ACI 318-11 D.7, as applicable.

**4.1.8 Minimum Member Thickness  $h_{min}$ , Anchor Spacing  $s_{min}$ , Edge Distance  $c_{min}$ :** In lieu of ACI 318-19 17.9.2, ACI 318-14 17.7.1 and 17.7.3 or ACI 318-11 D.8.1 and D.8.3, as applicable, values of  $s_{min}$  and  $c_{min}$  described in this report must be observed for anchor design and installation. The minimum member thicknesses,  $h_{min}$ , described in this report must be observed for anchor design and installation. For adhesive anchors that will remain untorqued, ACI 318-19 17.9.3, ACI 318-14 17.7.4 or ACI 318-11 D.8.4, as applicable, applies.

For anchors that will be torqued during installation, the maximum torque,  $T_{max}$ , must be reduced for edge distances less than five anchor diameters ( $5d$ ).  $T_{max}$  is subject to the edge distance,  $c_{min}$ , and anchor spacing,  $s_{min}$ , and shall comply with the following requirements:

MAXIMUM TORQUE SUBJECT TO EDGE DISTANCE			
NOMINAL ANCHOR SIZE, $d$	MIN. EDGE DISTANCE, $c_{min}$	MIN. ANCHOR SPACING, $s_{min}$	MAXIMUM TORQUE, $T_{max}$
all sizes	$5d$	$5d$	$1.0 \cdot T_{max}$
$\frac{3}{8}$ in. to 1 in. #3 to #8	1.75 in. (45 mm)	$5d$	$0.45 \cdot T_{max}$
$1\frac{1}{4}$ in. #9 to #10	2.75 in. (70 mm)		

For values of  $T_{max}$ , see Table 9 and Figure 4 of this report.

**4.1.9 Critical Edge Distance  $c_{ac}$  and  $\psi_{cp,Na}$ :** The modification factor  $\psi_{cp,Na}$ , must be determined in accordance with ACI 318-19 17.6.5.5, ACI 318-14 17.4.5.5 or ACI 318-11 D.5.5.5, as applicable, except as noted below:

For all cases where  $c_{Na}/c_{ac} < 1.0$ ,  $\psi_{cp,Na}$  determined from ACI 318-19 Eq. 17.6.5.5.1b, ACI 318-14 Eq. 17.4.5.5b or ACI 318-11 Eq. D-27, as applicable, need not be taken less than  $c_{Na}/c_{ac}$ . For all other cases,  $\psi_{cp,Na}$  shall be taken as 1.0.

The critical edge distance,  $c_{ac}$  must be calculated according to Eq. 17.6.5.5.1c for ACI 318-19, Eq. 17.4.5.5c for ACI 318-14 or Eq. D-27a for ACI 318-11, in lieu of ACI 318-19 17.9.5, ACI 318-14 17.7.6 or ACI 318-11 D.8.6, as applicable.

$$c_{ac} = h_{ef} \cdot \left( \frac{\tau_{k, uncr}}{1160} \right)^{0.4} \cdot \left[ 3.1 - 0.7 \frac{h}{h_{ef}} \right]$$

(Eq. 17.6.5.5.1c for ACI 318-19, Eq. 17.4.5.5c for ACI 318-14 or Eq. D-27a for ACI 318-11)

where

$\left[ \frac{h}{h_{ef}} \right]$  need not be taken as larger than 2.4; and

$\tau_{k, uncr}$  = the characteristic bond strength stated in the tables of this report whereby  $\tau_{k, uncr}$  need not be taken as larger than:

$$\tau_{k, uncr} = \frac{k_{uncr} \sqrt{h_{ef} f'_c}}{\pi \cdot d_a} \quad \text{Eq. (4-1)}$$

**4.1.10 Design Strength in Seismic Design Categories C, D, E and F:** In structures assigned to Seismic Design Category C, D, E or F under the IBC or IRC, anchors must be designed in accordance with ACI 318-19 17.10, ACI 318-14 17.2.3 or ACI 318-11 D.3.3, as applicable, except as described below.

The nominal steel shear strength,  $V_{sa}$ , must be adjusted by  $\alpha_{V, seis}$  as given in [Tables 4](#) and [5](#) for the corresponding anchor steel. The nominal bond strength  $\tau_{k, cr}$  must be adjusted by  $\alpha_{N, seis}$  as given in [Table 7](#) for threaded rods. An adjustment to the nominal bond strength  $\tau_{k, cr}$  is not required for reinforcing bars ( $\alpha_{N, seis} = 1.0$ .)

As an exception to ACI 318-11 D.3.3.4.2: Anchors designed to resist wall out-of-plane forces with design strengths equal to or greater than the force determined in accordance with ASCE 7 Equation 12.11-1 or 12.14-10 shall be deemed to satisfy ACI 318-11 D.3.3.4.3(d).

Under ACI 318-11 D.3.3.4.3(d), in lieu of requiring the anchor design tensile strength to satisfy the tensile strength requirements of ACI 318-11 D.4.1.1, the anchor design tensile strength shall be calculated from ACI 318-11 D.3.3.4.4.

The following exceptions apply to ACI 318-11 D.3.3.5.2:

1. For the calculation of the in-plane shear strength of anchor bolts attaching wood sill plates of bearing or non-bearing walls of light-frame wood structures to foundations or foundation stem walls, the in-plane shear strength in accordance with ACI 318-11 D.6.2 and D.6.3 need not be computed and ACI 318-11 D.3.3.5.3 need not apply provided all of the following are satisfied:
  - 1.1. The allowable in-plane shear strength of the anchor is determined in accordance with AF&PA NDS Table 11E for lateral design values parallel to grain.
  - 1.2. The maximum anchor nominal diameter is  $5/8$  inch (16 mm).
  - 1.3. Anchor bolts are embedded into concrete a minimum of 7 inches (178 mm).
  - 1.4. Anchor bolts are located a minimum of  $1\ 3/4$  inches (45 mm) from the edge of the concrete parallel to the length of the wood sill plate.
  - 1.5. Anchor bolts are located a minimum of 15 anchor diameters from the edge of the concrete perpendicular to the length of the wood sill plate.
  - 1.6. The sill plate is 2-inch or 3-inch nominal thickness.
2. For the calculation of the in-plane shear strength of anchor bolts attaching cold-formed steel track of bearing or non-bearing walls of light-frame construction to foundations or foundation stem walls, the in-plane shear strength in accordance with ACI 318-11 D.6.2 and D.6.3 need not be computed and ACI 318-11 D.3.3.5.3 need not apply provided all of the following are satisfied:
  - 2.1. The maximum anchor nominal diameter is  $5/8$  inch (16 mm).
  - 2.2. Anchors are embedded into concrete a minimum of 7 inches (178 mm).
  - 2.3. Anchors are located a minimum of  $1\ 3/4$  inches (45 mm) from the edge of the concrete parallel to the length of the track.
  - 2.4. Anchors are located a minimum of 15 anchor diameters from the edge of the concrete perpendicular to the length of the track.
  - 2.5. The track is 33 to 68 mil designation thickness. Allowable in-plane shear strength of exempt anchors, parallel to the edge of concrete shall be permitted to be determined in accordance with AISI S100 Section E3.3.1.

3. In light-frame construction, bearing or nonbearing walls, shear strength of concrete anchors less than or equal to 1 inch [25 mm] in diameter attaching a sill plate or track to foundation or foundation stem wall need not satisfy ACI 318-11 D.3.3.5.3(a) through (c) when the design strength of the anchors is determined in accordance with ACI 318-11 D.6.2.1(c).

#### 4.2 Allowable Stress Design (ASD):

**4.2.1 General:** For anchors designed using load combinations in accordance with Section 1605.1 of the 2021 IBC, or Section 1605.3 of the 2018, 2015, and 2012 IBC (Allowable Stress Design) loads must be established using the equations below:

$$T_{allowable,ASD} = \phi N_n / \alpha \quad (\text{Eq. 4-2})$$

and

$$V_{allowable,ASD} = \phi V_n / \alpha \quad (\text{Eq. 4-3})$$

where

$$T_{allowable,ASD} = \text{Allowable tension load (lbf or kN).}$$

$$V_{allowable,ASD} = \text{Allowable shear load (lbf or kN).}$$

$$\phi N_n = \text{Lowest design strength of an anchor or anchor group in tension as determined in accordance with ACI 318 (-19 and -14) Chapter 17 and 2021, 2018 or 2015 IBC Section 1905.1.8; ACI 318-11 Appendix D, and Section 4.1 of this report, as applicable (lbf or kN). For the 2012 IBC, Section 1905.1.9 shall be omitted.}$$

$$\phi V_n = \text{Lowest design strength of an anchor or anchor group in shear as determined in accordance with ACI 318 (-19 and -14) Chapter 17 and 2021, 2018 or 2015 IBC Section 1905.1.8; ACI 318-11 Appendix D, and Section 4.1 of this report, as applicable (lbf or kN). For the 2012 IBC, Section 1905.1.9 shall be omitted.}$$

$$\alpha = \text{Conversion factor calculated as a weighted average of the load factors for the controlling load combination. In addition, } \alpha \text{ must include all applicable factors to account for non-ductile failure modes and required over-strength.}$$

**4.2.2 Interaction of Tensile and Shear Forces:** Interaction must be calculated in accordance with ACI 318-19 17.8, ACI 318-14 17.6 or ACI 318-11 D.7, as applicable, as follows:

For shear loads  $V \leq 0.2 V_{allowable,ASD}$ , the full allowable load in tension shall be permitted.

For tension loads  $T \leq 0.2 T_{allowable,ASD}$ , the full allowable load in shear shall be permitted.

For all other cases:

$$\frac{T}{T_{allowable,ASD}} + \frac{V}{V_{allowable,ASD}} \leq 1.2 \quad \text{Eq. (4-4)}$$

#### 4.3 Installation:

Installation parameters are illustrated in [Figure 4](#) of this report. Installation must be in accordance with ACI 318-19 26.7.2, ACI 318-14 17.8.1 and 17.8.2 or ACI 318-11 D.9.1 and D.9.2, as applicable. Anchor locations must comply with this report and the plans and specifications approved by the code official. Installation of the AC100+ Gold Adhesive Anchor System must conform to the manufacturer's printed installation instructions (MPII) as reproduced in each unit package as described in [Figure 4](#). The injection tools, mixing nozzles, wire brushes, air blowers, and piston plugs along with the adhesive cartridges must be supplied by the manufacturer, as described in [Figure 4](#) of this report.

The adhesive anchor system may be used for upwardly inclined orientation applications (e.g. overhead). Upwardly inclined and horizontal orientation applications are to be installed using piston plugs for the  $\frac{5}{8}$ -inch through  $1\frac{1}{4}$ -inch diameter threaded steel rods and No. 5 through No. 10 steel reinforcing bars, installed in the specified hole diameter, and attached to the mixing nozzle and extension tube supplied by DEWALT as described in [Figure 4](#) in this report. Upwardly inclined and horizontal orientation installation for the  $\frac{3}{8}$ -inch and  $\frac{1}{2}$ -inch diameter threaded steel rods, and No. 3 and No. 4 steel reinforcing bars may be injected directly to the end of the hole using a mixing nozzle with a hole depth  $h_0 \leq 10"$  (250 mm).

Installation of anchors in horizontal or upwardly inclined orientations shall be fully restrained from movement throughout the specified curing period through the use of temporary wedges, external supports, or other methods. Where temporary restraint devices are used, their use shall not result in impairment of the anchor shear resistance.

#### 4.4 Special Inspection:

Periodic special inspection must be performed where required in accordance with Section 1705.1.1 and Table 1705.3 of the 2021, 2018, 2015 and 2012 IBC and this report. The special inspector must be on the jobsite initially during anchor installation to verify the anchor type, anchor dimensions, concrete type, concrete compressive strength, adhesive identification and expiration date, hole dimensions, hole cleaning procedures, anchor spacing, edge distances, concrete thickness, anchor embedment, tightening torque and adherence to the manufacturer's printed installation instructions (MPII). The special inspector must verify the initial installations of each type and size of adhesive anchor by construction personnel on site. Subsequent installations of the same anchor type and size by the same construction personnel are permitted to be performed in the absence of the special inspector. Any change in the anchor product being installed or the personnel performing the installation requires an initial inspection. For ongoing installations over an extended period, the special inspector must make regular inspections to confirm correct handling and installation of the product.

Continuous special inspection of adhesive anchors installed in horizontal or upwardly inclined orientations to resist sustained tension loads shall be performed in accordance with ACI 318-19 26.13.3.2(e), ACI 318-14 17.8.2.4, 26.7.1(h) and 26.13.3.2(c) or ACI 318-11 D.9.2.4, as applicable.

Under the IBC, additional requirements as set forth in Sections 1705, 1706 or 1707 must be observed, where applicable.

#### 4.5 Compliance with NSF/ANSI Standard 61:

The AC100+ Gold Adhesive Anchor System complies with the requirements of NSF/ANSI Standard 61, as referenced in Section 605 of the 2021, 2018, 2015, and 2012 *International Plumbing Code*<sup>®</sup> (IPC), and is certified for use as an anchoring adhesive for installing threaded rods less than or equal to 1.3 inches (33 mm) in diameter in concrete for water treatment applications. An NSF/ANSI Standard 61 listing is provided by NSF International.

### 5.0 CONDITIONS OF USE:

The AC100+ Gold Adhesive Anchor System described in this report complies with or is a suitable alternative to what is specified in the codes listed in Section 1.0 of this report, subject to the following conditions:

- 5.1 The AC100+ Gold adhesive anchors must be installed in accordance with this report and the manufacturer's printed installation instructions (MPII) as included with each cartridge and described in [Figure 4](#) of this report.
- 5.2 The anchors described in this report must be installed in cracked or uncracked normal-weight concrete or lightweight concrete having a specified compressive strength,  $f'_c = 2,500$  psi to 8,500 psi (17.2 MPa to 58.6 MPa).
- 5.3 The values of  $f'_c$  used for calculation purposes must not exceed 8,000 psi (55 MPa).
- 5.4 The concrete shall have attained its minimum design strength prior to installation of the anchors.
- 5.5 Anchors must be installed in concrete base materials in holes predrilled in accordance with the instructions provided in [Figure 4](#) of this report.
- 5.6 Loads applied to the anchors must be adjusted in accordance with Section 1605.2 of the IBC for strength design and in accordance with Section 1605.3 of the IBC for allowable stress design.
- 5.7 The AC100+ Gold adhesive anchors are recognized for use to resist short- and long-term loads, including wind and earthquake, subject to the conditions of this report.
- 5.8 In structures assigned to Seismic Design Categories C, D, E, and F under the IBC or IRC, anchor strength must be adjusted in accordance with Section 4.1.11 of this report.
- 5.9 The AC100+ Gold Adhesive Anchor System is permitted to be installed in concrete that is cracked or that may be expected to crack during the service life of the anchor, subject to the conditions of this report.
- 5.10 Strength design values are established in accordance with Section 4.1 of this report.
- 5.11 Allowable stress design values are established in accordance with Section 4.2 of this report.
- 5.12 Minimum anchor spacing and edge distance, as well as minimum member thickness, must comply with the values described in this report.
- 5.13 Prior to installation, calculations and details demonstrating compliance with this report must be submitted to the code official. The calculations and details must be prepared by a registered design professional where required by the statutes of the jurisdiction in which the project is to be constructed.

- 5.14 Anchors are not permitted to support fire-resistive construction. Where not otherwise prohibited by the code, AC100+ Gold adhesive anchors are permitted for installation in fire-resistive construction provided that at least one of the following conditions is fulfilled:
- Anchors are used to resist wind or seismic forces only.
  - Anchors that support gravity load-bearing structural elements are within a fire-resistive envelope or a fire-resistive membrane, are protected by approved fire-resistive materials, or have been evaluated for resistance to fire exposure in accordance with recognized standards.
  - Anchors are used to support nonstructural elements.
- 5.15 Since an ICC-ES acceptance criteria for evaluating data to determine the performance of adhesive anchors subjected to fatigue or shock loading is unavailable at this time, the use of these anchors under such conditions is beyond the scope of this report.
- 5.16 Use of zinc-plated carbon steel threaded rods or steel reinforcing bars is limited to dry, interior locations.
- 5.17 Use of hot-dipped galvanized carbon steel and stainless steel rods is permitted for exterior exposure or damp environments.
- 5.18 Steel anchoring materials in contact with preservative-treated wood and fire-retardant-treated wood must be of zinc-coated carbon steel or stainless steel. The minimum coating weights for zinc-coated steel must comply with ASTM A153.
- 5.19 Periodic special inspection must be provided in accordance with Section 4.4 in this report. Continuous special inspection for anchors installed in horizontal or upwardly inclined orientations to resist sustained tension loads must be provided in accordance with Section 4.4 of this report.
- 5.20 Installation of anchors in horizontal or upwardly inclined orientations to resist sustained tension loads shall be performed by personnel certified by an applicable certification program in accordance with ACI 318-19 26.7.1(l) and 26.7.2(e), ACI 318-14 17.8.2.2 or 17.8.2.3 or ACI 318-11 D.9.2.2 or D.9.2.3, as applicable.
- 5.21 Anchors shall not be used for installations where the in-service concrete temperature can vary from 40°F (5°C) or less to 80°F (27°C) or higher within a 12-hour period. Such applications may include but are not limited to anchorage of building facade systems and other applications subject to direct sun exposure.
- 5.22 AC100+ Gold adhesive is manufactured, under a quality-control program with inspections by ICC-ES.

## 6.0 EVIDENCE SUBMITTED

Data in accordance with the [ICC-ES Acceptance Criteria for Post-installed Adhesive Anchors in Concrete \(AC308\)](#), dated June 2019 (editorially revised February 2021), which incorporates requirements in ACI 355.4-19 and ACI 355.4-11 for use in cracked and uncracked concrete; including, but not limited to, tests under freeze/thaw conditions, tests under sustained load, tests for installation direction, tests at elevated temperatures, tests for resistance to alkalinity, tests for resistance to sulfur and tests for seismic tension and shear.

## 7.0 IDENTIFICATION

- 7.1 AC100+ Gold adhesive and additional listee product name described in Section 3.1 of this report are identified by packaging labelled with the lot number; expiration date; company name (DEWALT); and the evaluation report number (ESR-2582). Steel anchor elements including threaded rods, nuts, washers, and deformed reinforcing bars must conform to applicable national specifications as set forth in Section 3.2.4 and [Tables 2](#) and [3](#) of this evaluation report or equivalent.
- 7.2 The report holder's contact information is the following:

**DEWALT**  
**701 EAST JOPPA ROAD**  
**TOWSON, MARYLAND 21286**  
**(800) 524-3244**  
[www.DEWALT.com](http://www.DEWALT.com)  
[anchors@DEWALT.com](mailto:anchors@DEWALT.com)



TABLE 1—DESIGN USE AND TABLE INDEX

DESIGN STRENGTH <sup>1</sup>		THREADED ROD (FRACTIONAL) <sup>5</sup>		DEFORMED REINFORCING BAR <sup>5</sup>	
Steel	$N_{sa}, V_{sa}$	<a href="#">Table 4</a>		<a href="#">Table 5</a>	
Concrete	$N_{cb}, N_{cbg}, V_{cb}, V_{cbg}, V_{cp}, V_{cpb}$	<a href="#">Table 6</a>		<a href="#">Table 6</a>	
Bond <sup>2</sup>	$N_b, N_{bg}$	<a href="#">Table 7</a>		<a href="#">Table 8</a>	

CONCRETE TYPE	CONCRETE STATE	THREADED ROD DIAMETER (inch)	REINFORCING BAR SIZE (No.)	DRILLING METHOD <sup>4</sup>	MINIMUM EMBEDMENT	MAXIMUM EMBEDMENT	SEISMIC DESIGN CATEGORIES <sup>3</sup>
Normal-weight and lightweight	Cracked	1/2, 5/8, 3/4, 7/8, 1 and 1 1/4	4, 5, 6, 7, 8, 9, 10	Hammer-drill	See Table 7 and Table 8	See Table 7 and Table 8	A through F
	Uncracked	3/8, 1/2, 5/8, 3/4, 7/8, 1 and 1 1/4	3, 4, 5, 6, 7, 8, 9, 10	Hammer-drill	See Table 7 and Table 8	See Table 7 and Table 8	A and B

For SI: 1 inch = 25.4 mm. For pound-inch units: 1 mm = 0.03937 inch.

<sup>1</sup>Reference ACI 318-19 17.5.1, ACI 318-14 17.3.1.1 or ACI 318-11 D.4.1.1, as applicable. The controlling strength is decisive from all appropriate failure modes (i.e. steel, concrete, bond) and design assumptions.

<sup>2</sup>See Section 4.1.4 of this report for bond strength determination of post-installed adhesive anchors.

<sup>3</sup>See Section 4.1.11 for requirements for seismic design where applicable.

<sup>4</sup>Hammer-drill, i.e. rotary impact drills or rock drills with a carbide bit (including hollow drill bits).

<sup>5</sup>Anchors with 1/2-, 5/8-, 3/4-, 7/8-, 1- and 1 1/4-inch-diameter (12.7, 15.9, 19.1, 22.2, 25.4 and 31.8 mm) threaded steel rods and No. 4 through No. 10 steel reinforcing bars may be installed in normal-weight concrete that is cracked or that may be expected to crack during the service life of the anchor when installed in hammer-drilled holes. Anchors with 3/8-inch-diameter (9.5 mm) threaded steel rods and No. 3 steel reinforcing bars are limited to installation in uncracked concrete when installed in hammer-drilled holes.



The DEWALT drilling systems shown below collect and remove dust with a HEPA dust extractor during the hole drilling operation in dry base materials using hammer-drills (see step 1 of the manufacturer’s published installation instructions).

FIGURE 1—EXAMPLES DEWALT DUST REMOVAL DRILLING SYSTEMS WITH HEPA DUST EXTRACTORS FOR ILLUSTRATION

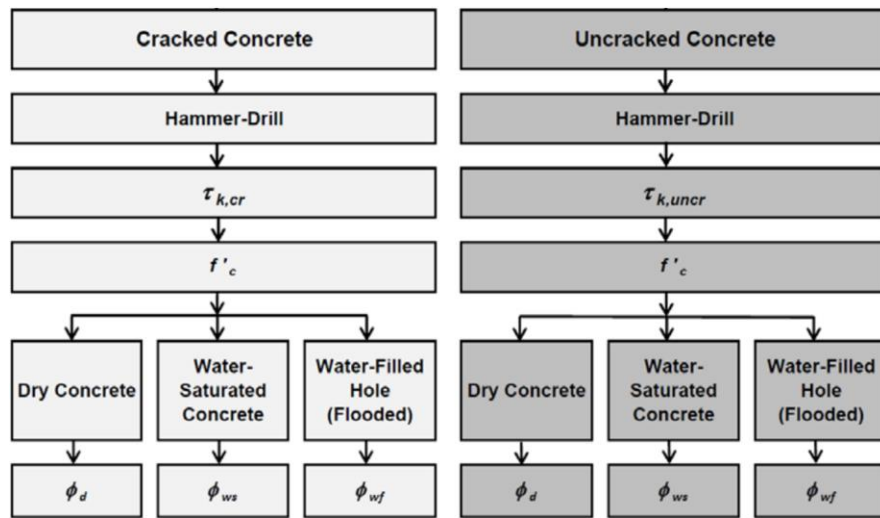

FIGURE 2—FLOW CHART FOR THE ESTABLISHMENT OF DESIGN BOND STRENGTH

TABLE 2—SPECIFICATIONS AND PHYSICAL PROPERTIES OF COMMON FRACTIONAL THREADED CARBON AND STAINLESS STEEL ROD MATERIALS<sup>1</sup>

THREADED ROD SPECIFICATION	UNITS	MIN. SPECIFIED ULTIMATE STRENGTH, $f_{uta}$	MIN. SPECIFIED YIELD STRENGTH 0.2 PERCENT OFFSET, $f_{ya}$	$\frac{f_{uta}}{f_{ya}}$	ELONGATION MINIMUM PERCENT <sup>8</sup>	REDUCTION OF AREA MINIMUM PERCENT	NUT SPECIFICATION <sup>9</sup>	
Carbon Steel	ASTM A36 <sup>2</sup> and F1554 <sup>3</sup> Grade 36	psi (MPa)	58,000 (400)	36,000 (248)	1.61	23	40 <sup>10</sup>	ASTM A194 / A563 Grade A
	ASTM F1554 <sup>3</sup> Grade 55	psi (MPa)	75,000 (517)	55,000 (380)	1.36	23	40	
	ASTM F1554 <sup>3</sup> Grade 105	psi (MPa)	125,000 (862)	105,000 (724)	1.19	15	45	ASTM A194 / A563 Grade D
	ASTM A193 <sup>4</sup> Grade B7	psi (MPa)	125,000 (860)	105,000 (720)	1.19	16	50	
	ASTM A449 <sup>5</sup> (3/8 to 1 inch dia.)	psi (MPa)	120,000 (828)	92,000 (635)	1.30	14	35	ASTM A194 / A563 Grade DH
	ASTM A449 <sup>5</sup> (1 1/4 inch dia.)	psi (MPa)	105,000 (720)	81,000 (559)	1.30	14	35	
Stainless Steel (Types 304 and 316)	ASTM F593 <sup>6</sup> CW1 (3/8 to 1/2 inch dia.)	psi (MPa)	100,000 (690)	65,000 (450)	1.54	20	- <sup>11</sup>	ASTM F594 Alloy Group 1, 2 or 3
	ASTM F593 <sup>6</sup> CW2 (3/4 to 1 1/4 inch dia.)	psi (MPa)	85,000 (590)	45,000 (310)	1.89	25	- <sup>11</sup>	
	ASTM A193 <sup>7</sup> Grade B8/B8M, Class 1	psi (MPa)	75,000 (517)	30,000 (207)	2.50	30	50	ASTM F594 Alloy Group 1, 2 or 3
	ASTM A193 <sup>7</sup> Grade B8/B8M2, Class 2B	psi (MPa)	95,000 (655)	75,000 (517)	1.27	25	40	

For **SI**: 1 inch = 25.4 mm, 1 psi = 0.006897 MPa. For **pound-inch** units: 1 mm = 0.03937 inch, 1 MPa = 145.0 psi.

<sup>1</sup>Adhesive must be used with continuously threaded carbon or stainless steels (all-thread) that have thread characteristics comparable with ANSI B1.1 UNC Coarse Thread Series. Tabulated values correspond to anchor diameters included in this report. See Section 3.2.4.3 of this report for ductility of steel anchor elements.

<sup>2</sup>Standard Specification for Carbon Structural Steel.

<sup>3</sup>Standard Specification for Anchor Bolts, Steel, 36, 55, and 105-ksi Yield Strength.

<sup>4</sup>Standard Specification for Alloy-Steel and Stainless Steel Bolting Materials for High Temperature or High Pressure Service and Other Special Purpose Applications.

<sup>5</sup>Standard Specification for Hex Cap Screws, Bolts and Studs, Steel, Heat Treated, 120/105/90 ksi Minimum Tensile Strength, General Use.

<sup>6</sup>Standard Specification for Stainless Steel Bolts, Hex Cap Screws, and Studs.

<sup>7</sup>Standard Standard Specification for Alloy-Steel and Stainless Steel Bolting for High Temperature or High Pressure Service and Other Special Purpose Applications.

<sup>8</sup>Based on 2-inch (50 mm) gauge length except ASTM A193, which are based on a gauge length of 4d.

<sup>9</sup>Nuts of other grades and style having specified proof load stress greater than the specified grade and style are also suitable. Nuts must have specified proof load stresses equal to or greater than the minimum tensile strength of the specified threaded rod. Material types of the nuts and washers must be matched to the threaded rods.

<sup>10</sup>Minimum percent reduction of area reported in ASTM A36 is 50 percent.

<sup>11</sup>Minimum percent reduction of area not reported in the referenced ASTM standard.

TABLE 3—SPECIFICATIONS AND PHYSICAL PROPERTIES OF COMMON STEEL REINFORCING BARS<sup>1</sup>

REINFORCING SPECIFICATION	UNITS	MINIMUM SPECIFIED ULTIMATE STRENGTH, $f_{uta}$	MINIMUM SPECIFIED YIELD STRENGTH, $f_{ya}$
ASTM A615 <sup>2</sup> , A767 <sup>4</sup> , Grade 75	psi (MPa)	100,000 (690)	75,000 (520)
ASTM A615 <sup>2</sup> , A767 <sup>4</sup> , Grade 60	psi (MPa)	90,000 (620)	60,000 (414)
ASTM A706 <sup>3</sup> , A767 <sup>4</sup> , Grade 60	psi (MPa)	80,000 (550)	60,000 (414)
ASTM A615 <sup>2</sup> , A767 <sup>4</sup> , Grade 40	psi (MPa)	60,000 (415)	40,000 (275)

For **SI**: 1 psi = 0.006897 MPa. For **pound-inch** units: 1 MPa = 145.0 psi.

<sup>1</sup>Adhesive must be used with specified deformed reinforcing bars. Tabulated values correspond to bar sizes included in this report.

<sup>2</sup>*Standard Specification for Deformed and Plain Carbon-Steel Bars for Concrete Reinforcement.* Grade 60 and Grade 40 bars may be considered ductile elements. In accordance with ACI 318-19 17.10.5.3(a)(vi), ACI 318-14 17.2.3.4.3(a)vi or ACI 318-11 D.3.3.4.3(a)6, as applicable, deformed reinforcing bars meeting this specification used as ductile steel elements to resist earthquake effects shall be limited to reinforcing bars satisfying the requirements of ACI 318 (-19 or -14) 20.2.2.4 and 20.2.2.5 or ACI 318-11 21.1.5.2(a) and (b). Grade 75 bars furnished to specification are considered brittle elements unless evidence is otherwise shown to the satisfaction of the registered design professional and code official in accordance with Section 3.2.4.3 of this report.

<sup>3</sup>*Standard Specification for Low-Alloy Steel Deformed and Plain Bars for Concrete Reinforcement.* Bars furnished to specification are considered ductile elements.

<sup>4</sup>*Standard Specification for Zinc-Coated (Galvanized) Steel Bars for Concrete Reinforcement.* Bars furnished to specification are considered brittle elements unless evidence is otherwise shown to the satisfaction of the registered design professional and code official in accordance with Section 3.2.4.3 of this report.

TABLE 4—STEEL DESIGN INFORMATION FOR FRACTIONAL THREADED ROD

DESIGN INFORMATION		SYMBOL	UNITS	NOMINAL ROD DIAMETER (inch) <sup>1</sup>						
				3/8	1/2	5/8	3/4	7/8	1	1 1/4
Threaded rod nominal outside diameter		<i>d</i>	inch (mm)	0.375 (9.5)	0.500 (12.7)	0.625 (15.9)	0.750 (19.1)	0.875 (22.2)	1.000 (25.4)	1.250 (31.8)
Threaded rod effective cross-sectional area		<i>A<sub>se</sub></i>	inch <sup>2</sup> (mm <sup>2</sup> )	0.0775 (50)	0.1419 (92)	0.2260 (146)	0.3345 (216)	0.4617 (298)	0.6057 (391)	0.9691 (625)
ASTM A36 and F1554, Grade 36	Nominal strength as governed by steel strength (for a single anchor)	<i>N<sub>sa</sub></i>	lbf (kN)	4,495 (20.0)	8,230 (36.6)	13,110 (58.3)	19,400 (86.3)	26,780 (119.1)	35,130 (156.3)	56,210 (250.0)
		<i>V<sub>sa</sub></i>	lbf (kN)	2,695 (12.0)	4,940 (22.0)	7,860 (35.0)	11,640 (51.8)	16,070 (71.4)	21,080 (93.8)	33,725 (150.0)
	Reduction factor for seismic shear	$\alpha_{V,seis}$	-	Not applicable	0.85	0.85	0.85	0.85	0.85	0.80
	Strength reduction factor for tension <sup>2</sup>	$\phi$	-	0.75						
	Strength reduction factor for shear <sup>2</sup>	$\phi$	-	0.65						
ASTM F1554, Grade 55	Nominal strength as governed by steel strength (for a single anchor)	<i>N<sub>sa</sub></i>	lbf (kN)	5,810 (25.9)	10,640 (47.3)	16,950 (75.4)	25,085 (111.6)	34,625 (154.0)	45,425 (202.0)	72,680 (323.3)
		<i>V<sub>sa</sub></i>	lbf (kN)	3,485 (15.5)	6,385 (28.4)	10,170 (45.2)	15,050 (67.0)	20,775 (92.4)	27,255 (121.2)	43,610 (194.0)
	Reduction factor for seismic shear	$\alpha_{V,seis}$	-	Not applicable	0.85	0.85	0.85	0.85	0.85	0.80
	Strength reduction factor for tension <sup>2</sup>	$\phi$	-	0.75						
	Strength reduction factor for shear <sup>2</sup>	$\phi$	-	0.65						
ASTM A193 Grade B7 and F1554, Grade 105	Nominal strength as governed by steel strength (for a single anchor)	<i>N<sub>sa</sub></i>	lbf (kN)	9,685 (43.1)	17,735 (78.9)	28,250 (125.7)	41,810 (186.0)	57,710 (256.7)	75,710 (336.8)	121,135 (538.8)
		<i>V<sub>sa</sub></i>	lbf (kN)	5,815 (25.9)	10,640 (47.3)	16,950 (75.4)	25,085 (111.6)	34,625 (154.0)	45,425 (202.1)	72,680 (323.3)
	Reduction factor for seismic shear	$\alpha_{V,seis}$	-	Not applicable	0.85	0.85	0.85	0.85	0.85	0.80
	Strength reduction factor for tension <sup>2</sup>	$\phi$	-	0.75						
	Strength reduction factor for shear <sup>2</sup>	$\phi$	-	0.65						
ASTM A449	Nominal strength as governed by steel strength (for a single anchor)	<i>N<sub>sa</sub></i>	lbf (kN)	9,300 (41.4)	17,025 (75.7)	27,120 (120.6)	40,140 (178.5)	55,905 (248.7)	63,600 (282.9)	101,755 (452.6)
		<i>V<sub>sa</sub></i>	lbf (kN)	5,580 (24.8)	10,215 (45.4)	16,270 (72.4)	24,085 (107.1)	33,540 (149.2)	38,160 (169.7)	61,050 (271.6)
	Reduction factor for seismic shear	$\alpha_{V,seis}$	-	Not applicable	0.80	0.80	0.80	0.80	0.80	0.80
	Strength reduction factor for tension <sup>2</sup>	$\phi$	-	0.75						
	Strength reduction factor for shear <sup>2</sup>	$\phi$	-	0.65						
ASTM F593 CW Stainless (Types 304 and 316)	Nominal strength as governed by steel strength (for a single anchor)	<i>N<sub>sa</sub></i>	lbf (kN)	7,750 (34.5)	14,190 (63.1)	22,600 (100.5)	28,430 (126.5)	39,245 (174.6)	51,485 (229.0)	82,370 (366.4)
		<i>V<sub>sa</sub></i>	lbf (kN)	4,650 (20.7)	8,515 (37.9)	13,560 (60.3)	17,060 (75.9)	23,545 (104.7)	30,890 (137.4)	49,425 (219.8)
	Reduction factor for seismic shear	$\alpha_{V,seis}$	-	Not applicable	0.85	0.85	0.85	0.85	0.85	0.80
	Strength reduction factor for tension <sup>2</sup>	$\phi$	-	0.65						
	Strength reduction factor for shear <sup>2</sup>	$\phi$	-	0.60						
ASTM A193 Grade B8/B8M, Class 1 Stainless (Types 304 and 316)	Nominal strength as governed by steel strength (for a single anchor) <sup>3</sup>	<i>N<sub>sa</sub></i>	lbf (kN)	4,420 (19.7)	8,090 (36.0)	12,880 (57.3)	19,065 (84.8)	26,315 (117.1)	34,525 (153.6)	55,240 (245.7)
		<i>V<sub>sa</sub></i>	lbf (kN)	2,650 (11.8)	4,855 (21.6)	7,730 (34.4)	11,440 (50.9)	15,790 (70.2)	20,715 (92.1)	33,145 (147.4)
	Reduction factor for seismic shear	$\alpha_{V,seis}$	-	Not applicable	0.85	0.85	0.85	0.85	0.85	0.80
	Strength reduction factor for tension <sup>2</sup>	$\phi$	-	0.75						
	Strength reduction factor for shear <sup>2</sup>	$\phi$	-	0.65						
ASTM A193 Grade B8/B8M2, Class 2B Stainless (Types 304 and 316)	Nominal strength as governed by steel strength (for a single anchor)	<i>N<sub>sa</sub></i>	lbf (kN)	7,365 (32.8)	13,480 (60.0)	21,470 (95.5)	31,775 (141.3)	43,860 (195.1)	57,545 (256.0)	92,065 (409.5)
		<i>V<sub>sa</sub></i>	lbf (kN)	4,470 (19.7)	8,085 (36.0)	12,880 (57.3)	19,065 (84.8)	26,315 (117.1)	34,525 (153.6)	55,240 (245.7)
	Reduction factor for seismic shear	$\alpha_{V,seis}$	-	Not applicable	0.85	0.85	0.85	0.85	0.85	0.80
	Strength reduction factor for tension <sup>2</sup>	$\phi$	-	0.75						
	Strength reduction factor for shear <sup>2</sup>	$\phi$	-	0.65						

For **SI**: 1 inch = 25.4 mm, 1 lbf = 4.448 N. For **pound-inch** units: 1 mm = 0.03937 inches, 1 N = 0.2248 lbf.

<sup>1</sup>Values provided for steel element material types based on minimum specified strengths and calculated in accordance with ACI 318-19 Eq. 17.6.1.2 and Eq. 17.7.1.2(b), ACI 318-14 Eq. 17.4.1.2 and Eq. 17.5.1.2b or ACI 318-11 Eq. D-2 and Eq. D-29, as applicable. Nuts must be appropriate for the rod, as listed in Table 2 of this report.

<sup>2</sup>The strength reduction factor applies when the load combinations from the IBC or ACI 318 are used and the requirements of ACI 318-19 17.5.3, ACI 318-14 17.3.3 or ACI 318-11 D.4.3, as applicable, are met. If the load combinations of ACI 318-11 Appendix C are used, the appropriate strength reduction factor must be determined in accordance with ACI 318-11 D.4.4.

<sup>3</sup>In accordance with ACI 318-19 Eq. 17.6.1.2 and Eq. 17.7.1.2, ACI 318-14 26.12.3.1(a) and 26.11.1.2(c) or ACI 318-11 D.5.1.2 and D.6.1.2, as applicable the calculated values for nominal tension and shear strength for ASTM A193 Grade B8/B8M Class 1 stainless steel threaded rods are based on limiting the specified tensile strength of the anchor steel to 1.9 $f_u$  or 57,000 psi (393 MPa).

TABLE 5—STEEL DESIGN INFORMATION FOR REINFORCING BARS

DESIGN INFORMATION		SYMBOL	UNITS	NOMINAL REINFORCING BAR SIZE (REBAR) <sup>1</sup>							
				No. 3	No. 4	No. 5	No. 6	No. 7	No. 8	No. 9	No. 10
Rebar nominal outside diameter		<i>d</i>	inch (mm)	0.375 (9.5)	0.500 (12.7)	0.625 (15.9)	0.750 (19.1)	0.875 (22.2)	1.000 (25.4)	1.125 (28.7)	1.250 (32.3)
Rebar effective cross-sectional area		<i>A<sub>se</sub></i>	inch <sup>2</sup> (mm <sup>2</sup> )	0.110 (71)	0.200 (129)	0.310 (200)	0.440 (284)	0.600 (387)	0.790 (510)	1.000 (645)	1.270 (819)
ASTM A615, Grade 75	Nominal strength as governed by steel strength (for a single anchor)	<i>N<sub>sa</sub></i>	lbf (kN)	11,000 (48.9)	20,000 (89.0)	31,000 (137.9)	44,000 (195.7)	60,000 (266.9)	79,000 (351.4)	100,000 (444.8)	127,000 (564.9)
		<i>V<sub>sa</sub></i>	lbf (kN)	6,600 (29.4)	12,000 (53.4)	18,600 (82.7)	26,400 (117.4)	36,000 (160.1)	47,400 (210.8)	60,000 (266.9)	76,200 (338.9)
	Reduction factor for seismic shear	$\alpha_{V,seis}$	-	Not applicable	0.70	0.70	0.70	0.70	0.70	0.70	0.70
	Strength reduction factor for tension <sup>2</sup>	$\phi$	-	0.65							
	Strength reduction factor for shear <sup>2</sup>	$\phi$	-	0.60							
ASTM A615, Grade 60	Nominal strength as governed by steel strength (for a single anchor)	<i>N<sub>sa</sub></i>	lbf (kN)	9,900 (44.0)	18,000 (80.1)	27,900 (124.1)	39,600 (176.1)	54,000 (240.2)	71,100 (316.3)	90,000 (400.3)	114,300 (508.4)
		<i>V<sub>sa</sub></i>	lbf (kN)	5,940 (26.4)	10,800 (48.0)	16,740 (74.5)	23,760 (105.7)	32,400 (144.1)	42,660 (189.8)	54,000 (240.2)	68,580 (305.0)
	Reduction factor for seismic shear	$\alpha_{V,seis}$	-	Not applicable	0.70	0.70	0.70	0.70	0.70	0.70	0.70
	Strength reduction factor for tension <sup>2</sup>	$\phi$	-	0.65							
	Strength reduction factor for shear <sup>2</sup>	$\phi$	-	0.60							
ASTM A706, Grade 60	Nominal strength as governed by steel strength (for a single anchor)	<i>N<sub>sa</sub></i>	lbf (kN)	8,800 (39.1)	16,000 (71.2)	24,800 (110.3)	35,200 (156.6)	48,000 (213.5)	63,200 (281.1)	80,000 (355.9)	101,600 (452.0)
		<i>V<sub>sa</sub></i>	lbf (kN)	5,280 (23.5)	9,600 (42.7)	14,880 (66.2)	21,120 (94.0)	28,800 (128.1)	37,920 (168.7)	48,000 (213.5)	60,960 (271.2)
	Reduction factor for seismic shear	$\alpha_{V,seis}$	-	Not applicable	0.70	0.70	0.70	0.70	0.70	0.70	0.70
	Strength reduction factor for tension <sup>2</sup>	$\phi$	-	0.75							
	Strength reduction factor for shear <sup>2</sup>	$\phi$	-	0.65							
ASTM A615, Grade 40	Nominal strength as governed by steel strength (for a single anchor)	<i>N<sub>sa</sub></i>	lbf (kN)	6,600 (29.4)	12,000 (53.4)	18,600 (82.7)	26,400 (117.4)	In accordance with ASTM A615, Grade 40 bars are furnished only in sizes No. 3 through No. 6			
		<i>V<sub>sa</sub></i>	lbf (kN)	3,960 (17.6)	7,200 (32.0)	11,160 (49.6)	15,840 (70.5)				
	Reduction factor for seismic shear	$\alpha_{V,seis}$	-	Not applicable	0.70	0.70	0.70				
	Strength reduction factor for tension <sup>2</sup>	$\phi$	-	0.65							
	Strength reduction factor for shear <sup>2</sup>	$\phi$	-	0.60							

For **SI**: 1 inch = 25.4 mm, 1 lbf = 4.448 N. For **pound-inch** units: 1 mm = 0.03937 inches, 1 N = 0.2248 lbf.

<sup>1</sup>Values provided for reinforcing bar material types based on minimum specified strengths and calculated in accordance with ACI 318-19 Eq. 17.6.1.2 and Eq. 17.7.1.2(b), ACI 318-14 Eq. 17.4.1.2 and Eq. 17.5.1.2b or ACI 318-11 Eq. D-2) and Eq. D-29, as applicable.

<sup>2</sup>The strength reduction factor applies when the load combinations from the IBC or ACI 318 are used and the requirements of ACI 318-19 17.5.3, ACI 318-14 17.3.3 or ACI 318-11 D.4.3, as applicable, are met. If the load combinations of ACI 318-11 Appendix C are used, the appropriate strength reduction factor must be determined in accordance with ACI 318-11 D.4.4.

TABLE 6—CONCRETE BREAKOUT AND PRYOUT DESIGN INFORMATION FOR FRACTIONAL THREADED ROD AND REINFORCING BARS IN HOLES DRILLED WITH A HAMMER DRILL AND CARBIDE BIT<sup>1</sup>

DESIGN INFORMATION	SYMBOL	UNITS	NOMINAL ROD DIAMETER (inch) / REINFORCING BAR SIZE							
			<sup>3</sup> / <sub>8</sub> or #3	<sup>1</sup> / <sub>2</sub> or #4	<sup>5</sup> / <sub>8</sub> or #5	<sup>3</sup> / <sub>4</sub> or #6	<sup>7</sup> / <sub>8</sub> or #7	1 or #8	#9	<sup>1</sup> / <sub>4</sub> or #10
Effectiveness factor for cracked concrete	<i>k<sub>c,cr</sub></i>	- (SI)	Not Applicable		17 (7.1)					
Effectiveness factor for uncracked concrete	<i>k<sub>c,uncr</sub></i>	- (SI)	24 (10.0)							
Minimum embedment	<i>h<sub>ef,min</sub></i>	inch (mm)	2 <sup>3</sup> / <sub>8</sub> (60)	2 <sup>3</sup> / <sub>4</sub> (70)	3 <sup>1</sup> / <sub>8</sub> (79)	3 <sup>1</sup> / <sub>2</sub> (89)	3 <sup>1</sup> / <sub>2</sub> (89)	4 (102)	4 <sup>1</sup> / <sub>2</sub> (114)	5 (127)
Maximum embedment	<i>h<sub>ef,max</sub></i>	inch (mm)	4 <sup>1</sup> / <sub>2</sub> (114)	6 (152)	7 <sup>1</sup> / <sub>2</sub> (191)	9 (229)	10 <sup>1</sup> / <sub>2</sub> (267)	12 (305)	13 <sup>1</sup> / <sub>2</sub> (343)	15 (381)
Minimum anchor spacing	<i>s<sub>min</sub></i>	inch (mm)	1 <sup>7</sup> / <sub>8</sub> (48)	2 <sup>1</sup> / <sub>2</sub> (64)	3 <sup>1</sup> / <sub>8</sub> (79)	3 <sup>3</sup> / <sub>4</sub> (95)	4 <sup>3</sup> / <sub>8</sub> (111)	5 (127)	5 <sup>5</sup> / <sub>8</sub> (143)	6 <sup>1</sup> / <sub>4</sub> (159)
Minimum edge distance	<i>c<sub>min</sub></i>	inch (mm)	5 <i>d</i> where <i>d</i> is nominal outside diameter of the anchor; see Section 4.1.9 of this report for design with reduced minimum edge distances (with reduced torque)							
Minimum member thickness	<i>h<sub>min</sub></i>	inch (mm)	<i>h<sub>ef</sub></i> + 1 <sup>1</sup> / <sub>4</sub> ( <i>h<sub>ef</sub></i> + 30)			<i>h<sub>ef</sub></i> + 2 <i>d<sub>o</sub></i> where <i>d<sub>o</sub></i> is hole diameter; for installation parameters see Table 9 of this report				
Critical edge distance—splitting (for uncracked concrete only)	<i>c<sub>ac</sub></i>	inch (mm)	See Section 4.1.10 of this report							
Strength reduction factor for tension, concrete failure modes, Condition B <sup>2</sup>	$\phi$	-	0.65							
Strength reduction factor for shear, concrete failure modes, Condition B <sup>2</sup>	$\phi$	-	0.70							

For **SI**: 1 inch = 25.4 mm, 1 lbf = 4.448 N. For **pound-inch** units: 1 mm = 0.03937 inch, 1 N = 0.2248 lbf.

<sup>1</sup>Additional setting information is described in the installation instructions, Figure 4 of this report.

<sup>2</sup>The strength reduction factor applies when the load combinations from the IBC or ACI 318 are used and the requirements of ACI 318-19 17.5.3, ACI 318-14 17.3.3 or ACI 318-11 D.4.3, as applicable, are met. If the load combinations of ACI 318-11 Appendix C are used, the appropriate strength reduction factor must be determined in accordance with ACI 318-11 D.4.4.

**TABLE 7—BOND STRENGTH DESIGN INFORMATION FOR FRACTIONAL THREADED RODS IN HOLES DRILLED WITH A HAMMER DRILL AND CARBIDE BIT<sup>1</sup>**

DESIGN INFORMATION		SYMBOL	UNITS	NOMINAL ROD DIAMETER (inch)						
				3/8	1/2	5/8	3/4	7/8	1	1 1/4
Minimum embedment		$h_{ef,min}$	inch (mm)	2 3/8 (60)	2 3/4 (70)	3 1/8 (79)	3 1/2 (89)	3 1/2 (89)	4 (102)	5 (127)
Maximum embedment		$h_{ef,max}$	inch (mm)	4 1/2 (114)	6 (152)	7 1/2 (191)	9 (229)	10 1/2 (267)	12 (305)	15 (381)
122°F (50°C) Maximum long-term service temperature; 176°F (80°C) maximum short-term service temperature <sup>2,3</sup>	Characteristic bond strength in cracked concrete <sup>4,6</sup>	$\bar{\tau}_{k,cr}$	psi (N/mm <sup>2</sup> )	Not applicable	498 (3.4)	519 (3.6)	519 (3.6)	519 (3.6)	519 (3.6)	525 (3.6)
	Characteristic bond strength in cracked concrete, short-term loads only <sup>6</sup>	$\bar{\tau}_{k,cr}$	psi (N/mm <sup>2</sup> )	Not applicable	712 (4.9)	742 (5.1)	742 (5.1)	742 (5.1)	742 (5.1)	751 (5.2)
	Characteristic bond strength in uncracked concrete <sup>4,7</sup>	$\bar{\tau}_{k,uncr}$	psi (N/mm <sup>2</sup> )	823 (5.7)	823 (5.7)	823 (5.7)	823 (5.7)	823 (5.7)	743 (5.1)	588 (4.1)
	Characteristic bond strength in uncracked concrete, short-term loads only <sup>7</sup>	$\bar{\tau}_{k,uncr}$	psi (N/mm <sup>2</sup> )	1,177 (8.1)	1,177 (8.1)	1,177 (8.1)	1,177 (8.1)	1,177 (8.1)	1,062 (7.3)	841 (5.8)
162°F (72°C) Maximum long-term service temperature; 248°F (120°C) maximum short-term service temperature <sup>2,3</sup>	Characteristic bond strength in cracked concrete <sup>4,6</sup>	$\bar{\tau}_{k,cr}$	psi (N/mm <sup>2</sup> )	Not applicable	245 (1.7)	255 (1.8)	255 (1.8)	255 (1.8)	255 (1.8)	255 (1.8)
	Characteristic bond strength in cracked concrete, short-term loads only <sup>6</sup>	$\bar{\tau}_{k,cr}$	psi (N/mm <sup>2</sup> )	Not applicable	544 (3.7)	566 (3.9)	566 (3.9)	566 (3.9)	566 (3.9)	566 (3.9)
	Characteristic bond strength in uncracked concrete <sup>4,7</sup>	$\bar{\tau}_{k,uncr}$	psi (N/mm <sup>2</sup> )	405 (2.8)	405 (2.8)	405 (2.8)	405 (2.8)	405 (2.8)	366 (2.5)	Not applicable
	Characteristic bond strength in uncracked concrete, short term loads only <sup>7</sup>	$\bar{\tau}_{k,uncr}$	psi (N/mm <sup>2</sup> )	899 (6.2)	899 (6.2)	899 (6.2)	899 (6.2)	899 (6.2)	813 (5.6)	Not applicable
Permissible installation conditions <sup>5</sup>	Dry concrete	$\phi_d$	-	0.65				0.65	0.65	0.65
	Water-saturated concrete	$\phi_{ws}$	-	0.55				0.55	0.55	0.55
	Water-filled hole (flooded)	$\phi_{wf}$	-	0.45				0.45	0.45	0.45
		$\kappa_{wf}$	-	0.78				0.70	0.69	0.67
Reduction factor for seismic tension		$\alpha_{N,seis}$	-	0.95						

For SI: 1 inch = 25.4 mm, 1 psi = 0.006894 MPa. For pound-inch units: 1 mm = 0.03937 inch, 1 MPa = 145.0 psi.

<sup>1</sup>Bond strength values correspond to concrete compressive strength  $f'_c = 2,500$  psi. For concrete compressive strength,  $f'_c$  between 2,500 psi and 8,000 psi, the tabulated characteristic bond strength may be increased by a factor of  $(f'_c / 2,500)^{0.13}$  [For SI:  $(f'_c / 17.2)^{0.13}$ ]. See Section 4.1.4 of this report.

<sup>2</sup>Long-term and short-term temperatures meet and exceed the requirements of Section 8.5 of ACI 355.4 and Table 9.1, Temperature Category A.

<sup>3</sup>Short-term elevated concrete temperatures are those that occur over brief intervals, e.g. as a result of diurnal cycling. Long-term concrete temperatures are roughly constant over significant periods of time.

<sup>4</sup>Characteristic bond strengths are for sustained loads including dead and live loads.

<sup>5</sup>Permissible installation conditions include dry concrete, water-saturated concrete and water-filled holes. Water-filled holes include applications in dry or water-saturated concrete where the drilled holes contain standing water during anchor installation. For installation instructions see Figure 4 of this report.

<sup>6</sup>For structures assigned to Seismic Design Categories C, D, E or F, bond strength values for cracked concrete must be adjusted by an additional reduction factor,  $\alpha_{N,seis}$ , as given in the table. See Section 4.1.11 of this report.

<sup>7</sup>Bond strength values for uncracked concrete are applicable for structures assigned to Seismic Design Categories A and B only.

**TABLE 8—BOND STRENGTH DESIGN INFORMATION FOR REINFORCING BARS IN HOLES DRILLED WITH A HAMMER DRILL AND CARBIDE BIT<sup>1</sup>**

DESIGN INFORMATION		SYMBOL	UNITS	REINFORCING BAR SIZE							
				#3	#4	#5	#6	#7	#8	#9	#10
Minimum embedment		$h_{ef,min}$	inch (mm)	2 <sup>3</sup> / <sub>8</sub> (60)	2 <sup>3</sup> / <sub>4</sub> (70)	3 <sup>1</sup> / <sub>8</sub> (79)	3 <sup>1</sup> / <sub>2</sub> (89)	3 <sup>1</sup> / <sub>2</sub> (89)	4 (102)	4 <sup>1</sup> / <sub>2</sub> (114)	5 (127)
Maximum embedment		$h_{ef,max}$	inch (mm)	4 <sup>1</sup> / <sub>2</sub> (114)	6 (152)	7 <sup>1</sup> / <sub>2</sub> (191)	9 (229)	10 <sup>1</sup> / <sub>2</sub> (267)	12 (305)	13 <sup>1</sup> / <sub>2</sub> (343)	15 (381)
122°F (50°C) Maximum long-term service temperature; 176°F (80°C) maximum short-term service temperature <sup>2,3</sup>	Characteristic bond strength in cracked concrete <sup>4,6</sup>	$\tau_{k,cr}$	psi (N/mm <sup>2</sup> )	Not applicable	331 (2.3)	345 (2.4)	345 (2.4)	345 (2.4)	345 (2.4)	349 (2.4)	349 (2.4)
	Characteristic bond strength in cracked concrete, short-term loads only <sup>6</sup>	$\tau_{k,cr}$	psi (N/mm <sup>2</sup> )	Not applicable	473 (3.3)	493 (3.4)	493 (3.4)	493 (3.4)	493 (3.4)	499 (3.4)	499 (3.4)
	Characteristic bond strength in uncracked concrete <sup>4,7</sup>	$\tau_{k,uncr}$	psi (N/mm <sup>2</sup> )	823 (5.7)	823 (5.7)	823 (5.7)	823 (5.7)	823 (5.7)	743 (5.1)	655 (5.1)	588 (4.1)
	Characteristic bond strength in uncracked concrete, short-term loads only <sup>7</sup>	$\tau_{k,uncr}$	psi (N/mm <sup>2</sup> )	1,117 (8.1)	1,117 (8.1)	1,117 (8.1)	1,117 (8.1)	1,117 (8.1)	1,062 (7.3)	951 (6.6)	841 (5.8)
162°F (72°C) Maximum long-term service temperature; 248°F (120°C) maximum short-term service temperature <sup>2,3</sup>	Characteristic bond strength in cracked concrete <sup>4,6</sup>	$\tau_{k,cr}$	psi (N/mm <sup>2</sup> )	Not applicable	163 (1.1)	170 (1.2)	170 (1.2)	170 (1.2)	170 (1.2)	170 (1.2)	170 (1.2)
	Characteristic bond strength in cracked concrete, short-term loads only <sup>6</sup>	$\tau_{k,cr}$	psi (N/mm <sup>2</sup> )	Not applicable	362 (2.5)	377 (2.6)	377 (2.6)	377 (2.6)	377 (2.6)	382 (2.6)	382 (2.6)
	Characteristic bond strength in uncracked concrete <sup>4,7</sup>	$\tau_{k,uncr}$	psi (N/mm <sup>2</sup> )	405 (2.8)	405 (2.8)	405 (2.8)	405 (2.8)	405 (2.8)	405 (2.8)	366 (2.5)	329 (2.3)
	Characteristic bond strength in uncracked concrete, short-term loads only <sup>7</sup>	$\tau_{k,uncr}$	psi (N/mm <sup>2</sup> )	899 (6.2)	899 (6.2)	899 (6.2)	899 (6.2)	899 (6.2)	899 (6.2)	813 (5.6)	730 (5.0)
Permissible installation conditions <sup>5</sup>	Dry concrete	$\phi_d$	-	0.65			0.65	0.65	0.65	0.65	0.65
	Water-saturated concrete	$\phi_{ws}$	-	0.55			0.55	0.55	0.55	0.55	0.55
	Water-filled hole (flooded)	$\phi_{wf}$	-	0.45			0.45	0.45	0.45	0.45	0.45
$K_{wf}$		-	0.78			0.70	0.69	0.68	0.67	0.67	
Reduction factor for seismic tension		$\alpha_{N,seis}$	-	1.0							

For **SI**: 1 inch = 25.4 mm, 1 psi = 0.006894 MPa. For **pound-inch** units: 1 mm = 0.03937 inch, 1 MPa = 145.0 psi.

<sup>1</sup>Bond strength values correspond to concrete compressive strength  $f'_c = 2,500$  psi. For concrete compressive strength,  $f'_c$  between 2,500 psi and 8,000 psi, the tabulated characteristic bond strength may be increased by a factor of  $(f'_c / 2,500)^{0.13}$  [For **SI**:  $(f'_c / 17.2)^{0.13}$ ]. See Section 4.1.4 of this report.

<sup>2</sup>Long-term and short-term temperatures meet and exceed the requirements of Section 8.5 of ACI 355.4 and Table 9.1, Temperature Category A.

<sup>3</sup>Short-term elevated concrete temperatures are those that occur over brief intervals, e.g. as a result of diurnal cycling. Long-term concrete temperatures are roughly constant over significant periods of time.

<sup>4</sup>Characteristic bond strengths are for sustained loads including dead and live loads.

<sup>5</sup>Permissible installation conditions include dry concrete, water-saturated concrete and water-filled holes. Water-filled holes include applications in dry or water-saturated concrete where the drilled holes contain standing water during anchor installation. For installation instructions see [Figure 4](#) of this report.

<sup>6</sup>For structures assigned to Seismic Design Categories C, D, E or F, the tabulated bond strength values for cracked concrete do not require an additional reduction factor applied for seismic tension ( $\alpha_{N,seis} = 1.0$ ), where seismic design is applicable. See Section 4.1.11 of this report for requirements for seismic design.

<sup>7</sup>Bond strength values for uncracked concrete are applicable for structures assigned to Seismic Design Categories A and B only.

TABLE 9—INSTALLATION PARAMETERS FOR FRACTIONAL THREADED ROD AND REINFORCING BARS

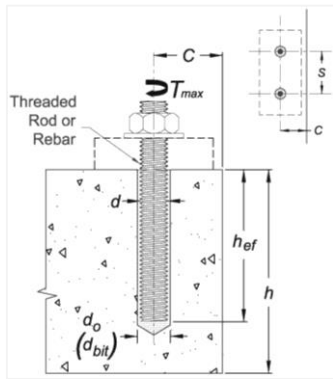

PARAMETER	SYMBOL	UNITS	NOMINAL ROD DIAMETER (inch) / REINFORCING BAR SIZE									
			<sup>3</sup> / <sub>8</sub> or #3	<sup>1</sup> / <sub>2</sub>	#4	<sup>5</sup> / <sub>8</sub> or #5	<sup>3</sup> / <sub>4</sub> or #6	<sup>7</sup> / <sub>8</sub> or #7	1 or #8	#9	1 <sup>1</sup> / <sub>4</sub>	#10
Threaded rod outside diameter	<i>d</i>	inch (mm)	0.375 (9.5)	0.500 (12.7)	0.625 (15.9)	0.750 (19.1)	0.875 (22.2)	1.000 (25.4)	N/A <sup>1</sup>	1.250 (31.8)	N/A <sup>1</sup>	
Rebar nominal outside diameter	<i>d</i>	inch (mm)	0.375 (9.5)	0.500 (12.7)	0.625 (15.9)	0.750 (19.1)	0.875 (22.2)	1.000 (25.4)	1.125 (28.7)	N/A <sup>1</sup>	1.250 (31.8)	
Carbide drill bit nominal size	<i>d<sub>o</sub></i> ( <i>d<sub>bit</sub></i> )	inch	<sup>7</sup> / <sub>16</sub>	<sup>9</sup> / <sub>16</sub>	<sup>5</sup> / <sub>8</sub>	<sup>11</sup> / <sub>16</sub> or <sup>3</sup> / <sub>4</sub>	<sup>7</sup> / <sub>8</sub>	1	1 <sup>1</sup> / <sub>8</sub>	1 <sup>3</sup> / <sub>8</sub>	1 <sup>3</sup> / <sub>8</sub>	1 <sup>1</sup> / <sub>2</sub>
Minimum embedment	<i>h<sub>ef,min</sub></i>	inch (mm)	2 <sup>3</sup> / <sub>8</sub> (60)	2 <sup>3</sup> / <sub>4</sub> (70)	3 <sup>1</sup> / <sub>8</sub> (79)	3 <sup>1</sup> / <sub>2</sub> (89)	3 <sup>1</sup> / <sub>2</sub> (89)	4 (102)	4 <sup>1</sup> / <sub>2</sub> (114)	5 (127)	5 (127)	
Maximum embedment	<i>h<sub>ef,max</sub></i>	inch (mm)	4 <sup>1</sup> / <sub>2</sub> (114)	6 (152)	7 <sup>1</sup> / <sub>2</sub> (191)	9 (229)	10 <sup>1</sup> / <sub>2</sub> (267)	12 (305)	13 <sup>1</sup> / <sub>2</sub> (343)	15 (381)	15 (381)	
Max. rod torque	<i>T<sub>max</sub></i>	ft-lbs	15	33	60	105	125	165	N/A <sup>1</sup>	280	N/A <sup>1</sup>	
Max. torque <sup>2</sup> (A36/Grade 36 rod)	<i>T<sub>max</sub></i>	ft-lbs	10	25	50	90	125	165	N/A <sup>1</sup>	280	N/A <sup>1</sup>	
Max. torque <sup>3</sup> (Class 1 SS rod)	<i>T<sub>max</sub></i>	ft-lbs	5	20	40	60	100	165	N/A <sup>1</sup>	280	N/A <sup>1</sup>	
Minimum anchor spacing	<i>S<sub>min</sub></i>	inch (mm)	1 <sup>7</sup> / <sub>8</sub> (48)	2 <sup>1</sup> / <sub>2</sub> (64)	3 <sup>1</sup> / <sub>8</sub> (79)	3 <sup>3</sup> / <sub>4</sub> (95)	4 <sup>3</sup> / <sub>8</sub> (111)	5 (127)	5 <sup>5</sup> / <sub>8</sub> (143)	6 <sup>1</sup> / <sub>4</sub> (159)	6 <sup>1</sup> / <sub>4</sub> (159)	
Minimum edge distance	<i>C<sub>min</sub></i>	inch (mm)	5 <i>d</i> ; or see Section 4.1.9 of this report for installation parameters with reduced minimum edge distances (with reduced torque)									
Minimum member thickness	<i>h<sub>min</sub></i>	inch (mm)	<i>h<sub>ef</sub></i> + 1 <sup>1</sup> / <sub>4</sub> ( <i>h<sub>ef</sub></i> + 30)			<i>h<sub>ef</sub></i> + 2 <i>d<sub>o</sub></i>						

For **SI**: 1 inch = 25.4 mm, 1 ft-lbf = 1.356 N-m. For **pound-inch** units: 1 mm = 0.03937 inch, 1 N-m = 0.7375 ft-lbf.

<sup>1</sup>N/A = Not Applicable.

<sup>2</sup>These values apply to ASTM A36 / F1554 Grade 36 carbon steel threaded rods.

<sup>3</sup>These values apply to ASTM A193 Grade B8/B8M (Class 1) stainless steel threaded rods.



FIGURE 3—AC100+ GOLD ADHESIVE ANCHOR SYSTEM INCLUDING TYPICAL STEEL ANCHOR ELEMENTS



TABLE 10—EXAMPLE OF AC100+ GOLD ADHESIVE ANCHOR ALLOWABLE STRESS DESIGN (ASD) VALUES FOR ILLUSTRATIVE PURPOSES<sup>1,2,3,4,6,9,10,13,14,16,17</sup>

NOMINAL ANCHOR ROD DIAMETER OR REBAR SIZE <i>d</i> (inch) / (No.)	EFFECTIVE EMBED. <sup>5</sup> <i>h<sub>ef</sub></i> (inches)	CONCRETE STRENGTH <sup>12</sup> <i>f<sub>c</sub></i> (psi)	EFFECTIVE-NESS FACTOR FOR UNCRACKED CONCRETE <i>k<sub>uncr</sub></i>	CHARACTERISTIC BOND STRENGTH <i>τ<sub>k,uncr</sub></i> (psi)		NOMINAL STRENGTH IN TENSION <i>N<sub>n</sub></i> (pounds)		STRENGTH REDUCTON FACTOR <i>φ<sup>15</sup></i>		ALLOWABLE TENSION LOAD <sup>11</sup> <i>φ N<sub>n</sub> / α</i> (pounds)	
				122°F LT, 176°F ST <sup>7</sup>	162°F LT, 248°F ST <sup>8</sup>	122°F LT, 176°F ST <sup>7</sup>	162°F LT, 248°F ST <sup>8</sup>	122°F LT, 176°F ST <sup>7</sup>	162°F LT, 248°F ST <sup>8</sup>	122°F LT, 176°F ST <sup>7</sup>	162°F LT, 248°F ST <sup>8</sup>
<b>ASTM A193 Grade B7 Threaded Rod</b>											
3/8	2 3/8	2,500	24	823	405	2,303	1,133	0.65 (bond)	0.65 (bond)	1,010	495
	4 1/2	2,500	24	823	405	4,363	2,147	0.65 (bond)	0.65 (bond)	1,915	945
1/2	2 3/4	2,500	24	823	405	3,555	1,749	0.65 (bond)	0.65 (bond)	1,560	765
	10	2,500	24	823	405	7,757	3,817	0.65 (bond)	0.65 (bond)	3,405	1,675
5/8	3 1/8	2,500	24	823	405	5,050	2,485	0.65 (bond)	0.65 (bond)	2,215	1,090
	12 1/2	2,500	24	823	405	12,120	5,964	0.65 (bond)	0.65 (bond)	5,325	2,620
3/4	3 1/2	2,500	24	823	405	6,787	3,340	0.65 (bond)	0.65 (bond)	2,980	1,465
	15	2,500	24	823	405	17,452	8,588	0.65 (bond)	0.65 (bond)	7,665	3,770
7/8	3 1/2	2,500	24	823	405	7,857	3,897	0.65 (conc)	0.65 (bond)	3,450	1,715
	17 1/2	2,500	24	823	405	23,755	11,690	0.65 (bond)	0.65 (bond)	10,430	5,135
1	4	2,500	24	743	366	9,337	4,599	0.65 (bond)	0.65 (bond)	4,100	2,020
	20	2,500	24	743	366	28,010	13,798	0.65 (bond)	0.65 (bond)	12,300	6,060
1 1/4	5	2,500	24	588	N/A	11,545	N/A	0.65 (bond)	N/A	5,070	N/A
	25	2,500	24	588	N/A	34,636	N/A	0.65 (bond)	N/A	15,215	N/A
<b>ASTM A706 Grade 60 Reinforcing Bar</b>											
3	2 3/8	2,500	24	823	405	2,303	1,133	0.65 (bond)	0.65 (bond)	1,010	495
	4 1/2	2,500	24	823	405	4,363	2,147	0.65 (bond)	0.65 (bond)	1,915	945
4	2 3/4	2,500	24	823	405	3,555	1,749	0.65 (bond)	0.65 (bond)	1,560	765
	10	2,500	24	823	405	7,757	3,817	0.65 (bond)	0.65 (bond)	3,405	1,675
5	3 1/8	2,500	24	823	405	5,050	2,485	0.65 (bond)	0.65 (bond)	2,215	1,090
	12 1/2	2,500	24	823	405	12,120	5,964	0.65 (bond)	0.65 (bond)	5,325	2,620
6	3 1/2	2,500	24	823	405	6,787	3,340	0.65 (bond)	0.65 (bond)	2,980	1,465
	15	2,500	24	823	405	17,452	8,588	0.65 (bond)	0.65 (bond)	7,665	3,770
7	3 1/2	2,500	24	823	405	7,857	3,897	0.65 (conc)	0.65 (bond)	3,450	1,715
	17 1/2	2,500	24	823	405	23,755	11,690	0.65 (bond)	0.65 (bond)	10,430	5,135
8	4	2,500	24	743	366	9,337	4,599	0.65 (bond)	0.65 (bond)	4,100	2,020
	20	2,500	24	743	366	28,010	13,798	0.65 (bond)	0.65 (bond)	12,300	6,060
9	4 1/2	2,500	24	665	329	11,545	5,233	0.65 (bond)	0.65 (bond)	5,070	2,295
	22 1/2	2,500	24	665	329	34,636	15,698	0.65 (bond)	0.65 (bond)	15,215	6,895
10	5	2,500	24	588	N/A	11,545	N/A	0.65 (bond)	N/A	5,070	N/A
	25	2,500	24	588	N/A	34,636	N/A	0.65 (bond)	N/A	15,215	N/A

For **SI**: 1 inch = 25.4 mm, 1 lbf = 4.448 N, 1 psi = 0.006894 MPa. For **pound-inch** units: 1 mm = 0.03937 inch, 1 N = 0.2248 lbf, 1 MPa = 145.0 psi.

<sup>1</sup>Single anchor with static tension load only; ASTM A193 Grade B7 threaded rod and ASTM A706 Grade 60 reinforcing bar.

<sup>2</sup>Vertical downward installation direction.

<sup>3</sup>Special inspection interval = Periodic.

<sup>4</sup>Installation temperature = 23°F (-5°C) to 104°F (40°C) for base material; 23°F (-5°C) to 95°F (35°C) for cartridge adhesive.

<sup>5</sup>Embedment = *h<sub>ef,min</sub>* and *h<sub>ef,max</sub>* for each diameter.

<sup>6</sup>Concrete determined to remain uncracked for the life of the anchorage.

<sup>7</sup>Long-term service temperature = 122°F (50°C), short-term service temperature = 176°F (80°C).

<sup>8</sup>Long-term service temperature = 162°F (72°C), short-term service temperature = 248°F (120°C).

<sup>9</sup>Load combinations are based on ACI 318-14 5.3 or ACI 318-11 9.2, as applicable, with no seismic loading considered.

<sup>10</sup>Thirty percent (30%) dead load and seventy percent (70%) live load; controlling load combination 1.2D + 1.6L.

<sup>11</sup>Calculation of weighted average for the conversion factor,  $\alpha = 1.2(0.3) + 1.6(0.7) = 1.48$ .

<sup>12</sup>*f<sub>c</sub>* = 2,500 psi compressive strength (normal-weight concrete).

<sup>13</sup>*C<sub>a1</sub>* = *C<sub>a2</sub>* ≥ *C<sub>ac</sub>*.

<sup>14</sup>*h* ≥ *h<sub>min</sub>*.

<sup>15</sup>Strength reduction factor from controlling nominal strength in tension [i.e. steel, concrete (conc), bond] decisive from design assumptions.

<sup>16</sup>Hammer-drilled holes in dry concrete.

<sup>17</sup>N/A = not applicable

# AC100+ Gold Instruction Card

**DESCRIPTION:**  
AC100+ Gold is an easy dispensing, rapid-curing, anchoring adhesive which is formulated for use in anchoring applications by trained professionals. Please refer to installation instructions and SDS for additional detailed information.

**PRECAUTION:**  
Safety glasses and dust masks should be used when drilling holes into concrete, stone and masonry. Wear gloves and safety glasses when handling and dispensing adhesive. Do not sand the adhesive and create silica dust which could be inhaled. Avoid skin and eye contact. Use a NIOSH-approved chemical mask to avoid respiratory discomfort if working indoors or in a confined area, or if sensitive to adhesive odors. Wash hands or other affected body parts with soap and water if skin contact occurs. Flush eyes with plenty of water and seek immediate medical attention if eye contact occurs. Move to fresh air if adhesive odor begins to cause discomfort.

**IMPORTANT! Before using, read and review Safety Data Sheet (SDS).**  
This product contains crystalline silica and as supplied does not pose a dust hazard. IARC classifies crystalline silica (quartz sand) as a Group 1 carcinogen based upon evidence among workers in industries where there has been long-term and chronic exposure (via inhalation) to silica dust; e.g. mining, quarry, stone crushing, refractory brick and pottery workers. This product does not pose a dust hazard, therefore, this classification is not relevant. However, if reacted (fully cured) product is further processed (e.g. sanded, drilled) be sure to wear proper respiratory and eye protection to avoid health risk.

**HANDLING AND STORAGE:**  
Store in a cool, dry, well ventilated area at temperatures between 32°F (0°C) and 86°F (30°C). Do not freeze. Store and keep away from flame, heat and light. Keep partially used containers closed when not in use. Protect from damage.

**Note expiration date on product label before use. Do not use expired product.** Partially used cartridges may be stored with hardened adhesive in the attached mixing nozzle. **Note:** If the cartridge is reused, attach a new mixing nozzle and discard the initial quantity of the anchor adhesive as described in the setting instructions.

**DEWALT**  
701 East Joppa Road  
Towson, MD 21286 U.S.A.  
anchors@DEWALT.com  
www.DEWALT.com  
P: (800) 524-3244 [N]

[V.] Adhesive piston plungers				
Threaded rod diameter (inch)	Rebar size (no.)	Drill bit diameter (inch)	Plug Size (inch)	Piston Plug (Cat. #)
5/8	#5	11/16	3/4	08258-PWR
3/4	#6	7/8	7/8	08300-PWR
7/8	#7	1	1	08301-PWR
1	#8	1 1/8	1 1/8	08303-PWR
1 1/4	#9	1 5/8	1 5/8	08305-PWR
-	#10	1 7/8	1 7/8	08309-PWR

Horizontal and overhead installations.<sup>2</sup>  
A plastic extension tube (Cat# 08281) or equivalent approved by DEWALT must be used with piston plungers.  
2. All listed overhead anchor installations require piston plungers; horizontal installations with embedments greater than 8 inches require piston plungers.



## [I.] Hole cleaning tools - wire brushes and air blowers

Threaded rod diameter (inch)	Rebar size (No.)	Drill bit size <sup>1</sup> (inch)	Brush length (inches)	Steel wire brush (Cat. #)	Air Blowers
3/8	#3	7/16	6 3/4	08284	Hand pump (volume 25 fl. oz.) Cat. #08280-PWR or compressed air nozzle (min. 90 psi)
1/2	-	9/16	6 3/4	08285	Compressed air nozzle only (min. 90 psi). Cat. #08292-PWR
5/8	#4	5/8	6 3/4	08275	
3/4	#5	1 1/16	7 1/8	08286	
7/8	#6	7/8	7 1/8	08287	
1	#7	1	11 7/8	08288	
1 1/4	#8	1 1/8	11 7/8	08289	
-	#9	1 3/8	11 7/8	08290	
-	#10	1 7/8	11 7/8	08291	

A brush extension (Cat. #08282) must be used with brushes for holes drilled deeper than the listed brush length.  
For installations with 5/8-inch threaded rod and #5 rebar size, the preferred ANSI drill bit diameter is 3/4-inch. If an 11/16-inch ANSI drill bit is used the user must check before injecting the adhesive to verify that the steel anchor element can be inserted into the cleaned hole without resistance.

Temperature of base material	Gel (working) time	Full curing time
14°F	90 minutes	24 hours
23°F	90 minutes	14 hours
32°F	45 minutes	7 hours
41°F	25 minutes	2 hours
68°F	6 minutes	45 minutes
86°F	4 minutes	25 minutes
104°F	1.5 minutes	15 minutes

Linear interpolation for intermediate base material temperatures is possible. For installations in base material temperature between 14°F and 23°F the cartridge temperature must be conditioned to between 68°F and 95°F (20°C - 35°C).

## [III.] Installation parameters - Specifications for installation of threaded rods and reinforcing bars

Anchor property / Setting information	Threaded rod (inch) / reinforcing bar size (rebar)								
	3/8 or #3	1/2	#4	5/8 or #5	3/4 or #6	7/8 or #7	1 or #8	#9	#10
$d$ = Threaded rod outside diameter (in.)	0.375	0.500	0.500	0.625	0.750	0.875	1.000	1.000	1.250
$d$ = Nominal rebar diameter (in.)	0.375	0.500	0.625	0.750	0.875	1.000	1.125	-	1.250
$d_d$ (d <sub>th</sub> ) = Nominal ANSI drill bit size (in.)	7/16	9/16	5/8	1 1/16 or 3/4	7/8	1	1 1/8	1 3/8	1 7/8
$h_{el min}$ = Minimum embedment (inches)	2 9/16	2 3/4	3 1/8	3 1/2	3 1/2	3 1/2	4	4 1/2	5
$h_{el max}$ = Maximum embedment (inches)	4 1/2	6	7 1/2	9	10 1/2	12	13 1/2	15	15
$s_{min}$ = Minimum spacing (inches)	1 7/8	2 1/2	3 1/8	3 3/4	4 3/8	5	5 5/8	6 1/4	6 1/4
$s_{min}$ = Minimum edge distance (inches)	1 3/4	1 3/4	1 3/4	1 3/4	1 3/4	1 3/4	1 3/4	2 3/4	2 3/4
$h_{min}$ = Minimum member thickness (inches)	$h_{el} + 1 1/4$		$h_{el} + 2d_c$						
$T_{max}$ = Maximum rod torque (ft.-lb.)	15	33	60	105	125	165	165	280	-
$T_{max}$ = Maximum torque (ft.-lb.) for A36/Grade 36 rod	10	25	50	90	125	165	165	280	-
$T_{max}$ = Maximum torque (ft.-lb.) for Grade B8/B8M Class 1 rod	5	20	40	60	100	165	165	280	-

For installations between the minimum edge distance and  $s_d$ , the tabulated maximum torque must be reduced (multiplied) by a factor of 0.45.



## [IV.] AC100+ Gold adhesive anchor system selection table

Dispensers	Plastic cartridge system	Mixing nozzle
Cat. #08437-PWR - Manual tool	AC100+ Gold 9.5 fl. oz. Quick-Shot w/nozzle	Mixing nozzle and extension tube
Cat. #0CE60D1 - Cordless battery tool	AC100+ Gold 11.5 fl. oz. dual cart. w/nozzle	Cat. #08293-PWR or PFC1641600
Cat. #084495-PWR - Manual tool	AC100+ Gold 14 fl. oz. coaxial cart. w/nozzle	
Cat. #08414-PWR - Manual tool	AC100+ Gold 28 fl. oz. dual cart. w/nozzle	Long mixing nozzle and extension tube
Cat. #08494-PWR - Manual tool		Cat. #08294-PWR or 08609-PWR
Cat. #08496-PWR - Pneumatic tool		
Cat. #DCE695E1 - Cordless battery tool		

A plastic extension tube (Cat# 08281-PWR or 08297-PWR) or flexible extension hose (Cat.# PFC1640600) or equivalent approved by DEWALT must be used if the bottom or back of the anchor hole is not reached with the mixing nozzle only.

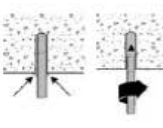

FIGURE 4—MANUFACTURER'S PUBLISHED INSTALLATION INSTRUCTIONS (MPII)

## AC100+ Gold - Instruction Card (continued)

<p style="text-align: center;"><b>HOLE CLEANING DRY OR WET HOLES</b></p> <div style="display: flex; justify-content: space-around;"> <div style="text-align: center;">  <p>Brush 4x</p> </div> <div style="text-align: center;">  <p>Blow 4x</p> </div> </div> <p style="text-align: center;">Repeat Blowing 4x</p>	<p style="text-align: center;"><b>HAMMER DRILLING</b></p> <div style="display: flex; justify-content: space-around;">  </div>
<p><b>2.2a</b> Starting from the bottom or back of the drilled anchor hole, blow the hole clean a minimum of four times (4X). Use a compressed air nozzle (min. 90 psi) for all sizes of anchor rod and reinforcing bar (rebar). Alternatively a hand pump (min. volume 25 fl. oz. supplied by DEWALT) may be used for anchor rods 3/8" to 3/4" diameter or reinforcing bar (rebar) sizes #3 to #6 for embedments not more than 8 inches (a hand pump must not be used with larger anchor sizes).</p> <p><b>2.2b</b> Determine brush diameter (see Table I) for the drilled hole and attach the brush with an adaptor to a rotary drill tool or battery screw gun. Brush the hole with the selected wire brush a minimum of four times (4X). A brush extension (supplied by DEWALT) must be used for holes drilled deeper than the listed brush length. The wire brush diameter must be checked periodically during use; the brush should resist insertion into the drilled hole, if not the brush is too small and must be replaced with the proper brush diameter (i.e. new wire brush).</p> <p><b>2.2c</b> Repeat Step 2a again by blowing the hole clean a minimum of four times (4X). When finished the hole should be clean and free of dust, debris, ice, grease, oil or other foreign material. → Next go to Step 3.</p>	<p><b>1</b> Drill a hole into the base material with rotary hammer drill (i.e. percussion drill) and a carbide drill bit to the size and embedment required by the selected steel hardware element (see Table III). Tolerances of carbide drill bits including hollow drill bits must meet ANSI Standard B212.15. <b>Precaution:</b> Wear suitable eye and skin protection. Avoid inhalation of dusts during drilling and/or removal (see dust extraction equipment by DEWALT to minimize dust emissions). <b>Notes:</b> In case of standing water in the drilled hole (flooded hole condition), all the water has to be removed from the hole (e.g. vacuum, compressed air, etc.) prior to cleaning. Drilling in dry concrete is recommended when using hollow drill bits (vacuum must be on).</p>

**SELECT HAMMER DRILLING AS SUITABLE FOR APPLICATION**

Installation instructions for Adhesive Anchors in solid base material – For any application not covered by this document please contact DEWALT

<p style="text-align: center;"><b>CURING AND FIXTURE</b></p> <div style="display: flex; justify-content: space-around;">  </div>	<p style="text-align: center;"><b>INSTALLATION</b></p> <div style="display: flex; justify-content: space-around;">  </div>	<p style="text-align: center;"><b>PREPARING</b></p> <div style="display: flex; justify-content: space-around;">  </div>
<p><b>10</b> After full curing of the adhesive anchor, a fixture can be installed to the anchor and tightened up to the maximum torque (shown in Table III) by using a calibrated torque wrench. <b>Note:</b> Take care not to exceed the maximum torque for the selected anchor.</p>	<p><b>3</b> Ensure that the anchor element is installed to the specified embedment depth. Adhesive must completely fill the annular gap at the concrete surface. Following installation of the anchor element, remove excess adhesive. Protect the anchor element threads from fouling with adhesive. For all installations the anchor element must be restrained from movement throughout the specified curing period (where necessary) through the use of temporary wedges, external supports, or other methods. Minor adjustments to the position of the anchor element may be performed during the gel time only.</p> <p><b>4</b> The anchor should be free of dirt, grease, oil or other foreign material. Push clean threaded rod or reinforcing bar into the anchor hole while turning slightly to ensure positive distribution of the adhesive until the embedment depth is reached. Observe the gel (working) time.</p> <p><b>5</b> Fill the cleaned hole approximately two-thirds full with mixed adhesive starting from the bottom or back of the anchor hole. If the bottom or back of the anchor hole is not reached with the mixing nozzle only, a plastic extension tube must be used (see Table IV). Slowly withdraw the mixing nozzle as the hole fills to avoid creating air pockets or voids. <b>Note:</b> Piston plugs (see Table V) must be used with and attached to mixing nozzle and extension tube for overhead and horizontal installations with anchor rod 5/8" to 1-1/4" diameter and rebar size #5 to #10. Insert piston plug to the back of the drilled hole and inject as described in the method above. During installation the piston plug will be naturally extruded from the drilled hole by the adhesive pressure. <b>Attention!</b> Do not install anchors overhead without proper training and installation hardware provided by DEWALT; contact DEWALT prior to use.</p>	<p><b>2</b> Check adhesive expiration date on cartridge label. Do not use expired product. Review Safety Data Sheet (SDS) before use. Cartridge temperature must be between 23°F - 104°F (-5°C - 40°C) when in use except as noted in Table II. Review published working and cure times. Consideration should be given to the reduced gel (working) time of the adhesive in warm temperatures. For the permitted range of the base material temperature see Table II. Attach a supplied mixing nozzle to the cartridge. Do not modify the mixer in any way and make sure the mixing element is inside the nozzle. Load the cartridge into the correct dispensing tool. <b>Note:</b> Always use a new mixing nozzle with new cartridges of adhesive and also for all work interruptions exceeding the published gel (working) time of the adhesive. <b>3</b> Prior to inserting the anchor rod or rebar into the filled hole, the position of the embedment depth has to be marked on the anchor. Verify anchor element is straight and free of surface damage. <b>4</b> Adhesive must be properly mixed to achieve published properties. Prior to dispensing adhesive into the drilled hole, separately dispense at least three full strokes of adhesive through the mixing nozzle until the adhesive is a consistent gray color. Review and note the published working and cure times (see Table II) prior to injection of the mixed adhesive into the cleaned anchor hole.</p>

**FOLLOW STEPS #1 THROUGH #10 FOR RECOMMENDED INSTALLATION**

FIGURE 4—MANUFACTURER'S PUBLISHED INSTALLATION INSTRUCTIONS (MPII) (continued)

**DIVISION: 03 00 00—CONCRETE**  
**Section: 03 16 00—Concrete Anchors**

**DIVISION: 05 00 00—METALS**  
**Section: 05 05 19—Post-installed Concrete Anchors**

**REPORT HOLDER:**

DEWALT

**EVALUATION SUBJECT:**

**AC100+ GOLD® ADHESIVE ANCHOR SYSTEM IN CRACKED AND UNCRACKED CONCRETE (DEWALT)**

**1.0 REPORT PURPOSE AND SCOPE**

**Purpose:**

The purpose of this evaluation report supplement is to indicate that AC100+ Gold adhesive anchor system in cracked and uncracked concrete, described in ICC-ES evaluation report [ESR-2582](#), has also been evaluated for compliance with the codes noted below as adopted by Los Angeles Department of Building and Safety (LADBS).

**Applicable code editions:**

- 2020 *City of Los Angeles Building Code* (LABC)
- 2020 *City of Los Angeles Residential Code* (LARC)

**2.0 CONCLUSIONS**

The AC100+ Gold adhesive anchor system in cracked and uncracked concrete, described in Sections 2.0 through 7.0 of the evaluation report [ESR-2582](#), complies with LABC Chapter 19, and LARC, and is subject to the conditions of use described in this report.

**3.0 CONDITIONS OF USE**

The AC100+ Gold adhesive anchor system described in this evaluation report supplement must comply with all of the following conditions:

- All applicable sections in the evaluation report [ESR-2582](#).
- The design, installation, conditions of use and labeling of the anchor system are in accordance with the 2018 *International Building Code*® (IBC) provisions noted in the evaluation report [ESR-2582](#).
- The design, installation and inspection are in accordance with additional requirements of LABC Chapters 16 and 17, as applicable.
- Under the LARC, an engineered design in accordance with LARC Section R301.1.3 must be submitted.
- The allowable and strength design values listed in the evaluation report and tables are for the connection of the anchor system to the concrete. The connection between the anchor system and the connected members shall be checked for capacity (which may govern).
- For use in wall anchorage assemblies to flexible diaphragm applications, anchors shall be designed per the requirements of City of Los Angeles Information Bulletin P/BC 2020-071.

This supplement expires concurrently with the evaluation report, reissued February 2024.

**DIVISION: 03 00 00—CONCRETE**

Section: 03 16 00—Concrete Anchors

**DIVISION: 05 00 00—METALS**

Section: 05 05 19—Post-Installed Concrete Anchors

**REPORT HOLDER:**

DEWALT

**EVALUATION SUBJECT:**

AC100+ GOLD® ADHESIVE ANCHOR SYSTEM IN CRACKED AND UNCRACKED CONCRETE (DEWALT)

**1.0 REPORT PURPOSE AND SCOPE****Purpose:**

The purpose of this evaluation report supplement is to indicate that the AC100+ Gold Adhesive Anchor System in cracked and uncracked concrete, described in ICC-ES evaluation report ESR-2582, has also been evaluated for compliance with the codes noted below.

**Applicable code editions:**

- 2020 Florida Building Code—Building
- 2020 Florida Building Code—Residential

**2.0 CONCLUSIONS**

The AC100+ Gold® Adhesive Anchor System in cracked and uncracked concrete, described in Sections 2.0 through 7.0 of the evaluation report ESR-2582, complies with the *Florida Building Code—Building* and the *Florida Building Code—Residential*, provided the design requirements are determined in accordance with the *Florida Building Code—Building* or the *Florida Building Code—Residential*, as applicable. The installation requirements noted in ICC-ES evaluation report ESR-2582 for the 2018 *International Building Code*® meet the requirements of the *Florida Building Code—Building* or the *Florida Building Code—Residential*, as applicable.

Use of the AC100+ Gold® adhesive anchors has also been found to be in compliance with the High-Velocity Hurricane Zone provisions of the *Florida Building Code—Building* and *Florida Building Code—Residential* with the following condition:

- a) For connections subject to uplift, the connection must be designed for no less than 700 pounds (3114 N).

For products falling under Florida Rule 61G20-3, verification that the report holder's quality assurance program is audited by a quality assurance entity approved by the Florida Building Commission for the type of inspections being conducted is the responsibility of an approved validation entity (or the code official, when the report holder does not possess an approval by the Commission).

This supplement expires concurrently with the evaluation report, reissued February 2024.