

# ICC-ES Evaluation Report

ESR-3657

Reissued December 2024

Revised April 2025

Subject to renewal December 2025

This report also contains:

- [City of LA Supplement](#)



- [FL Supplement w/ HVHZ](#)

For references to other reports.

See ELC-3657 for [National Building Code of Canada](#)® (NBCC)

ICC-ES Evaluation Reports are not to be construed as representing aesthetics or any other attributes not specifically addressed, nor are they to be construed as an endorsement of the subject of the report or a recommendation for its use. There is no warranty by ICC Evaluation Service, LLC, express or implied, as to any finding or other matter in this report, or as to any product covered by the report.

Copyright © 2025 ICC Evaluation Service, LLC. All rights reserved.

<p><b>DIVISION: 03 00 00—</b> <b>CONCRETE</b></p> <p><b>Section: 03 15 19—Cast-</b> <b>In Concrete Anchors</b></p> <p><b>Section: 03 16 00—</b> <b>Concrete Anchors</b></p>	<p><b>REPORT HOLDER:</b> <b>DEWALT</b></p> 	<p><b>EVALUATION SUBJECT:</b></p> <p><b>WOOD-KNOCKER® II+ AND PAN-KNOCKER™ II+ CONCRETE INSERTS FOR FORMS AND BANG-IT®+ CONCRETE INSERTS FOR STEEL DECK IN CRACKED AND UNCRACKED CONCRETE (DEWALT)</b></p>	
---	--	--	---

## 1.0 EVALUATION SCOPE

### Compliance with the following codes:

- 2024, 2021, 2018, and 2015 [International Building Code](#)® (IBC)
- 2024, 2021, 2018, and 2015 [International Residential Code](#)® (IRC)

Main references of this report are for the 2024 IBC and IRC. See [Table 10](#) and [Table 11](#) for applicable sections of the code for previous IBC and IRC editions.

### Property evaluated:

- Structural

## 2.0 USES

The Wood-Knocker II+ and Pan-Knocker II+ concrete inserts are used as anchorage to resist static, wind, and seismic tension and shear loads in cracked and uncracked normal-weight concrete, sand-lightweight, and all-lightweight concrete having a specified compressive strength,  $f'_c$ , of 2,500 psi to 10,000 psi (17.2 MPa to 68.9 MPa).

The Bang-It+ steel deck concrete inserts are used to resist static, wind, and seismic tension and shear loads in the soffit of cracked and uncracked normal-weight concrete and sand-lightweight concrete on steel deck having a specified compressive strength,  $f'_c$ , of 2,500 psi to 10,000 psi (17.2 MPa to 68.9 MPa).

There are eighteen models for the Wood-Knocker II+ inserts; fifteen fractional and three metric: 1/4-inch, 1/4-inch LP (low profile), 1/4 & 3/8-inch Multi LP (low profile), 1/4 & 3/8-inch Multi, 1/4 & 3/8 & 1/2-inch Multi, 3/8-inch, 3/8-inch LP (low profile), 3/8-inch Push-In thread, 3/8 & 1/2-inch Multi, 3/8 & 1/2 & 5/8-inch Multi, 1/2-inch, 1/2-inch Push-In thread, 5/8-inch, 5/8 & 3/4-inch Multi, 3/4-inch, M10, M10 & M12 Multi, and M12 corresponding to the sizes of the threaded rods or bolts used for the inserts.

There are twelve models for the Pan-Knocker II+ inserts; nine fractional and three metric: 1/4 & 3/8-inch Multi LP (low profile), 1/4 & 3/8 & 1/2-inch Multi, 3/8-inch, 3/8-inch Push-In thread, 3/8 & 1/2-inch Multi, 3/8 & 1/2 & 5/8-inch Multi, 1/2-inch, 1/2-inch Push-In thread, 5/8 & 3/4-inch Multi, M10, M10 & M12 Multi, and M12 corresponding to the sizes of the threaded rods or bolts used for the inserts.

There are fifteen models for the Bang-It+ inserts; twelve fractional and three metric: 1/4-inch, 1/4 & 3/8-inch Multi, 1/4 & 3/8 & 1/2-inch Multi, 3/8-inch, 3/8-inch Push-In thread, 3/8 & 1/2-inch Multi, 3/8 & 1/2 & 5/8-inch Multi, 1/2-inch, 1/2-inch Push-In thread, 5/8-inch, 5/8 & 3/4-inch Multi, 3/4-inch, M10, M10 & M12 Multi, and M12 corresponding to the sizes of the threaded rods or bolts used for the inserts.

Inserts denoted as ‘Multi’ have an internal step thread and can accept more than one size of threaded rod or bolt, depending on the insert.

Inserts denoted as ‘Push-In thread’ have an internal thread which can accept threaded rods or bolts securely without turning the rod or bolt during installation.

Reference to “inserts” in this report refers to the headed cast-in specialty anchorage products (Wood-Knocker II+, Pan-Knocker II+, and Bang-It+) used in concrete; reference to “steel elements” refers to threaded rods or bolts; reference to “anchors” in this report refers to the installed inserts in concrete with threaded rods or bolts.

The inserts are alternatives to cast-in anchors described in Section 1901.3 of the 2024 IBC. The anchors may be used where an engineered design is submitted in accordance with Section R301.1.3 of the IRC.

## 3.0 DESCRIPTION

**3.1 Wood-Knocker II+, Pan-Knocker II+ and Bang-It+ Inserts:** The Wood-Knocker II+ and Pan-Knocker II+ inserts are cast-in concrete form inserts. The inserts consists of a steel headed insert (body) which is internally threaded and an outer plastic sleeve. The Wood-Knocker II+ also has nails used to attach the insert to the inside surface of concrete formwork, and the Pan-Knocker II+ is attached to the form without nails (e.g. using screws). The inserts are illustrated in [Figures 1A, 1B](#) and [6](#). The internally threaded inserts are manufactured from low carbon steel. The inserts have minimum 5  $\mu\text{m}$  (0.0002-inch) zinc plating, except for the plastic sleeve which is fabricated from polypropylene.

The Bang-It+ steel deck inserts are cast-in concrete inserts. The insert consists of a steel headed insert (body) which is internally threaded, an outer spring, a plastic sleeve and a base plate washer. The inserts are illustrated in [Figures 2](#) and [7](#). The internally threaded inserts are manufactured from low carbon steel. The base plates are manufactured from low carbon steel or polypropylene. The spring is manufactured from steel music wire. The Bang-It+ inserts have a minimum 5  $\mu\text{m}$  (0.0002-inch) zinc plating except for the plastic sleeve and plastic base plate which is fabricated from polypropylene.

The anchor assembly is comprised of a Wood-Knocker II+, Pan-Knocker II+ or Bang-It+ insert with a threaded steel element (e.g. rod or bolt). The Wood-Knocker II+ insert is installed on the inside surface of wood formwork and the head driven down until it comes into contact with the plastic sleeve and the nails enter the form. The Pan-Knocker II+ insert is installed on the inside surface of formwork and attached to the form with the insert base (e.g. using screws). The Bang-It+ insert is installed in a predrilled hole in the topside of the metal deck, and impacted or pressed with sufficient force to compress the spring and drive the flared plastic fins of the sleeve completely through the hole. Concrete can then be cast over the inserts.

### 3.2 Steel Elements:

**3.2.1 Threaded Steel Rods and Bolts:** Threaded steel rods (all-thread) or bolts must be threaded on their embedded end in diameters as described in [Table 7](#) of this report. Specifications for grades of common threaded rod or bolts, including the mechanical strength properties are described in [Table 6](#) of this report. Carbon steel threaded rods or bolts may be furnished with a minimum 0.0002-inch-thick (5  $\mu\text{m}$ ) zinc plating.

**3.2.2 Ductility:** In accordance with ACI 318-19 Section 2.3, in order for a steel anchor element to be considered ductile, the tested elongation must be at least 14 percent and the reduction of area must be at least 30 percent. Steel anchor elements with a tested elongation of less than 14 percent or a reduction of area less than 30 percent, or both, are considered brittle. Values for common steel threaded rod elements are provided in [Tables 6](#) and [7](#) of this report. Where values are nonconforming or unstated, the steel anchor element must be considered brittle.

### 3.3 Concrete:

Normal-weight, sand-lightweight, and all-lightweight concrete must conform to Sections 1903 and 1905 of the 2024 IBC.

### 3.4 Steel Deck Panels:

Steel deck panels must be in accordance with the configuration in [Figures 4A, 4B](#) and [4C](#) and have a minimum base steel thickness of 22 gauge [0.034 inch (0.864 mm)]. Steel must comply with ASTM A653/A653M SS Grade 33 minimum and have a minimum yield strength of 33,000 psi (228 MPa).

## 4.0 DESIGN AND INSTALLATION

### 4.1 Strength Design:

**4.1.1 General:** Design strength of anchors complying with the 2024 IBC as well as Section R301.1.3 of the 2024 IRC must be determined in accordance with ACI 318-19 Chapter 17 and this report.

Design parameters provided in [Tables 2A, 2B, 3A, 3B, 5A](#) and [5B](#) of this report are based on the 2024 IBC (ACI 318-19), unless noted otherwise in Sections 4.1.1 through 4.1.12. The strength design of anchors must comply with ACI 318-19 Section 17.5.1.2, except as required in ACI 318-19 Section 17.10.

Strength reduction factors,  $\phi$ , as given in ACI 318-19 Section 17.5.3 for cast-in headed anchors, must be used for load combinations calculated in accordance with Section 1605.1 of the 2024 IBC and Section 5.3 of ACI 318-19. The value of  $f'_c$  used in the calculations must be limited to a maximum of 10,000 psi (68.9 MPa), in accordance with ACI 318-19 Section 17.3.1.

The pullout strength in tension is not decisive for design and does not need to be evaluated.

**4.1.2 Requirements for Static Steel Strength in Tension:** The nominal static steel strength in tension,  $N_{sa}$ , of a single anchor must be calculated in accordance with ACI 318-19 Section 17.6.1 for the threaded steel element,  $N_{sa,rod}$ , as illustrated in [Table 7](#) of this report. The lesser of  $\phi N_{sa,rod}$  in [Table 7](#) or  $\phi N_{sa,insert}$  provided in [Tables 2A, 2B, 3A, 3B, 5A](#) and [5B](#) shall be used as the steel strength in tension.

**4.1.3 Requirements for Static Concrete Breakout Strength in Tension:** For the Wood-Knocker II+, Pan-Knocker II+, and Bang-It+ anchors, the nominal concrete breakout strength of a single anchor or group of anchors in tension,  $N_{cb}$  or  $N_{cbg}$ , respectively, must be calculated in accordance with ACI 318-19 Section 17.6.2 for cast-in headed bolts, with modifications as described in this section, and with [Figures 3, 4A, 4B](#) and [4C](#) of this report, as applicable. The basic concrete breakout strength in tension,  $N_b$ , must be calculated in accordance with ACI 318-19 Section 17.6.2.2 using the values of  $h_{ef}$  given in [Tables 2A, 2B, 3A, 3B, 5A](#) and [5B](#), and with  $k_c = 24$ . The nominal concrete breakout strength in tension in regions where analysis indicates no cracking in accordance with ACI 318-19 Section 17.6.2.5 must be calculated with  $\psi_{c,N} = 1.25$ . For the Bang-It+ inserts installed in the soffit of sand-lightweight or normal-weight concrete filled steel deck assemblies, the contribution of the steel deck strength must be ignored and the calculation of  $A_{Nc} / A_{Nco}$  in accordance with ACI 318-19 Section 17.6.2.1 and  $c_{a,min}$  (minimum edge distance) must be based on [Figures 4A, 4B](#) and [4C](#).

**4.1.4 Requirements for Static Side-Face Blowout Strength in Tension:** For the Wood-Knocker II+ and Pan-Knocker II+ anchors, the nominal side-face blowout strength of a headed insert,  $N_{sb}$ , calculated in accordance with ACI 318-19 Section 17.6.4.1 for the cast-in headed insert, in cracked and uncracked concrete, is not decisive for design and is not required to be calculated.

For the Bang-It+ anchors installed in the soffit of sand-lightweight or normal-weight concrete on steel deck floor and roof assemblies as shown in [Figures 4A, 4B](#) and [4C](#), calculation of the concrete side-face blowout strength is not decisive for design and is not required to be calculated.

**4.1.5 Requirements for Static Steel Strength in Shear:** For Wood-Knocker II+ and Pan-Knocker II+ anchors, the nominal static steel strength in shear,  $V_{sa}$ , of a single anchor must be taken as the threaded steel element strength,  $V_{sa,rod}$ , given in [Table 7](#) of this report. The lesser of  $\phi V_{sa,rod}$  in [Table 7](#) or  $\phi V_{sa,insert}$  in [Tables 2A, 2B](#) or [5A](#) shall be used as the steel strength in shear, and must be used in lieu of the values derived by calculation from ACI 318-19 Eq. 17.7.1.2a or 17.7.1.2b.

For Bang-It+ anchors, the nominal static steel strength in shear,  $V_{sa,deck}$ , of a single Bang-It+ insert, in the lower flute and upper flute of concrete filled steel deck assemblies, must be taken as the threaded steel element strength,  $V_{sa,rod}$ , given in [Table 7](#) of this report. The lesser of  $\phi V_{sa,rod}$  in [Table 7](#) or  $\phi V_{sa,insert,deck}$  in [Tables 3A, 3B](#) or [5B](#) shall be used as the steel strength in shear, and must be used in lieu of the values derived by calculation from ACI 318-19 Eq. 17.7.1.2a or 17.5.1.2b.

**4.1.6 Requirements for Static Concrete Breakout Strength in Shear:** For Wood-Knocker II+ and Pan-Knocker II+ anchors, the nominal concrete breakout strength of a single anchor or group of anchors in shear,  $V_{cb}$  or  $V_{cbg}$ , respectively, must be calculated in accordance with ACI 318-19 Section 17.7.2. The basic concrete breakout strength,  $V_b$ , must be calculated in accordance with ACI 318-19 Section 17.7.2.2, based on the values provided in [Tables 3A](#) and [3B](#). The value of  $\ell_e$  used in ACI 318-19 Eq. 17.7.2.2.1a must be taken as no greater than the lesser of  $h_{ef}$  or  $8d_a$ .

For the Bang-It+ anchors installed in the soffit of sand-lightweight or normal-weight concrete on steel deck floor and roof assemblies, as shown in [Figures 4A, 4B](#) and [4C](#), the breakout strength in shear need not be calculated.

**4.1.7 Requirements for Static Concrete Pryout Strength in Shear:** For Wood-Knocker II+ and Pan-Knocker II+ anchors, the nominal concrete pryout strength of a single anchor or group of anchors,  $V_{cp}$  or  $V_{cpg}$ , respectively, must be calculated in accordance with ACI 318-19 Section 17.7.3.

For the Bang-It+ anchors installed in the soffit of sand-lightweight or normal-weight concrete filled steel deck assemblies, as shown in [Figures 4A, 4B](#) and [4C](#), calculation of the concrete pry-out strength in accordance with ACI 318-19 Section 17.7.3 is not required.

#### 4.1.8 Requirements for Seismic Design:

**4.1.8.1 General:** For load combinations including seismic, the design must be performed in accordance with ACI 318-19 Section 17.10. Modifications to ACI 318-19 Section 17.10 shall be applied under Section 1905.7 of the 2024 IBC. The anchors may be installed in Seismic Design Categories A through F of the IBC.

For Wood-Knocker II+ and Pan-Knocker II+ anchors, the nominal concrete breakout strength and nominal concrete side-face blowout strength for anchors in tension; and the nominal concrete breakout strength and pryout strength in shear, must be calculated in accordance with ACI 318-19 Sections 17.6 and 17.7.

For Bang-It+ anchors, the nominal concrete breakout strength for anchors in tension must be calculated in accordance with ACI 318-19 Section 17.6.

**4.1.8.2 Seismic Tension:** For Wood-Knocker II+ and Pan-Knocker II+ anchors, the nominal steel strength in tension,  $N_{sa}$ , of a single anchor must be calculated in accordance with ACI 318-19 Section 17.6.1 for the threaded steel element,  $N_{sa,rod,eq}$ , as given in [Table 7](#), not to exceed the corresponding values of  $N_{sa,insert,eq}$  in [Tables 2A](#), [2B](#) or [5A](#) of this report; the nominal concrete breakout strength for anchors in tension must be calculated in accordance with ACI 318-19 Section 17.6.2 as described in Section 4.1.3 of this report; the nominal concrete side-face blowout strength must be calculated in accordance with ACI 318-19 Sections 17.6.4.1 and 17.6.4.2, and Section 4.1.4 of this report.

For Bang-It+ anchors, the nominal steel strength in tension,  $N_{sa}$ , of a single anchor must be calculated in accordance with ACI 318-19 Section 17.6.1 for the threaded steel element,  $N_{sa,rod,eq}$ , as given in [Table 7](#), not to exceed the corresponding values of  $N_{sa,insert,eq}$  in [Tables 3A](#), [3B](#) or [5B](#) of this report; the nominal concrete breakout strength for anchors in tension must be calculated in accordance with ACI 318-19 Section 17.6.2, as described in Section 4.1.3 of this report; the nominal concrete pullout strength calculations in accordance with ACI 318-19 Sections 17.6.3.1 and 17.6.3.2.2a are not required.

**4.1.8.3 Seismic Shear:** For Wood-Knocker II+ and Pan-Knocker II+ anchors, the nominal concrete breakout strength and pryout strength in shear must be calculated in accordance with ACI 318-19 Sections 17.7.2 and 17.7.3, as described in Sections 4.1.6 and 4.1.7 of this report. In accordance with ACI 318-19 Section 17.7.1.2, the nominal steel strength for seismic loads,  $V_{sa,eq}$ , must be taken as the threaded steel element strength,  $V_{sa,rod,eq}$ , given in [Table 7](#) of this report, not to exceed the corresponding values of  $V_{sa,insert,eq}$ , in [Tables 2A](#), [2B](#) or [5A](#).

For Bang-It+ anchors, the nominal concrete breakout strength and pryout strength in shear, calculations in accordance with ACI 318-19 Sections 17.7.2 and 17.7.3, as described in Sections 4.1.6 and 4.1.7 of this report, are not required. In accordance with ACI 318-19 Section 17.7.1.2, the nominal steel strength for seismic loads,  $V_{sa,eq}$ , must be taken as the threaded steel element strength,  $V_{sa,rod,eq}$ , given in [Table 7](#) of this report, not to exceed the corresponding values of  $V_{sa,insert,eq,deck}$ , in [Tables 3A](#), [3B](#) or [5B](#), for lower flute or upper flute of the concrete filled steel deck assembly, as applicable.

**4.1.9 Requirements for Interaction of Tensile and Shear Forces:** For designs that include combined tension and shear, the interaction of tension and shear loads must be calculated in accordance with ACI 318-19 Section 17.8.

Due to the projection of the internally-threaded end of the Bang-It+ single thread inserts and multi thread inserts when installed in concrete filled steel deck assemblies (approximately  $3/4$ -inch), for anchors or groups of anchors that are subject to the effects of combined tension and shear forces, the design engineer must verify the validity of the interaction equation in ACI 318-19 Section 17.8.

**4.1.10 Requirements for Minimum Member Thickness, Minimum Anchor Spacing and Minimum Edge Distance:** Requirements on headed cast-in specialty anchor edge distance, spacing, member thickness, and concrete strength must be in accordance with the requirements in ACI 318-19 for cast-in bolts and the information in [Tables 1A](#), [1B](#) and [4](#), as applicable.

For Bang-It+ anchors installed in the soffit of sand-lightweight or normal-weight concrete over profile steel deck floor and roof assemblies, the anchors must be installed in accordance with [Tables 1A](#), [1C](#) and [4](#), as applicable, as well as [Figures 4A](#), [4B](#) and [4C](#), as applicable.

**4.1.11 Requirements for Critical Edge Distance:** The critical edge distance,  $c_{ac}$ , must be calculated in accordance with ACI 318-19 Section 17.9.2. The modification factor  $\Psi_{cp,N} = 1.0$  in accordance with ACI 318-19 Section 17.6.2.6.

**4.1.12 Lightweight Concrete:** For ACI 318-19, when the Wood-Knocker II+ and Pan-Knocker II+ anchors are used in sand-lightweight or all-lightweight concrete, the modification factor  $\lambda_a$ , for concrete breakout strength must be taken as 0.85 for sand-lightweight or 0.75 for all-lightweight according to ACI 318-19 Section 17.2.4.

For Bang-It+ anchors in the soffit of sand-lightweight concrete-filled steel deck,  $\lambda_a$  shall be taken as 0.85 and applied to the concrete breakout strength in tension only as applicable. Values are shown in [Tables 3A](#), [3B](#) or [5B](#) and installation details are shown in [Figures 4A](#), [4B](#) and [4C](#).

## 4.2 Allowable Stress Design (ASD):

**4.2.1 General:** Design values for use with allowable stress design (working stress design) load combinations calculated in accordance with Section 1605.1 of the 2024 IBC must be established as follows:

$$T_{allowable,ASD} = \frac{\phi N_n}{\alpha}$$

$$V_{allowable,ASD} = \frac{\phi V_n}{\alpha}$$

where:

$T_{allowable,ASD}$  = Allowable tension load (lbf or kN).

$V_{allowable,ASD}$  = Allowable shear load (lbf or kN).

$\phi N_n$  = Lowest design strength of an anchor or anchor group in tension as determined in accordance with ACI 318-19 Chapter 17, 2024 IBC Section 1905.7, and Section 4.1 of this report (lbf or N).

$\phi V_n$  = Lowest design strength of an anchor or anchor group in shear as determined in accordance with ACI 318-19 Chapter 17, 2024 IBC Section 1905.7, and Section 4.1 of this report (lbf or N).

$\alpha$  = Conversion factor calculated as a weighted average of the load factors for the controlling load combination. In addition,  $\alpha$  must include all applicable factors to account for non-ductile failure modes and required over-strength.

The requirements for member thickness, edge distance and spacing, described in this report, must apply. Examples of allowable stress design values for tension and shear for illustrative purposes are shown in [Tables 8A, 8B, 9A, and 9B](#). The values presented in [Tables 8A, 8B, 9A, and 9B](#) are only valid when all of the conditions given in the footnotes to the respective tables are applicable.

**4.2.2 Interaction of Tensile and Shear Forces:** For designs that include combined tension and shear, the interaction of tension and shear loads must be calculated in accordance with ACI 318-19 Section 17.8, as follows:

For shear loads  $V_{applied} \leq 0.2V_{allowable,ASD}$ , the full allowable load in tension must be permitted.

For tension loads  $T_{applied} \leq 0.2T_{allowable,ASD}$ , the full allowable load in shear must be permitted.

For all other cases:

$$\frac{T_{applied}}{T_{allowable,ASD}} + \frac{V_{applied}}{V_{allowable,ASD}} \leq 1.2 \quad (\text{Eq-1})$$

Due to the projection of the internally-threaded end of the Bang-It+ single thread inserts and multi thread inserts when installed in concrete filled steel deck assemblies (approximately  $3/4$ -inch), for anchors or groups of anchors that are subject to the effects of combined tension and shear forces, the design engineer must verify the validity of the interaction equation in ACI 318-19 Section 17.8.

### 4.3 Installation:

For the Wood-Knocker II+ and Pan-Knocker II+ inserts, installation parameters are provided in [Tables 1A, 1B or 4](#) and in [Figures 3 and 8](#). For the Wood-Knocker II+, the head of the insert must be impacted with sufficient force until it comes into contact with the plastic sleeve and the nails enter the form to secure it. For the Pan-Knocker II+, the base of the insert must be attached to the form using screws or other means to secure the insert. From beneath the deck, following the concrete pour and form removal, a threaded rod or bolt element must be turned into the internal threads of the steel body, or pushed in for the Push-In thread, until fully seated in the inserts. The threaded steel rod or bolt element must have a minimum thread engagement equal to one steel element diameter.

For the Bang-It+ inserts, installation parameters are provided in [Tables 1A, 1C, or 4](#) and in [Figures 4A, 4B, 4C and 8](#). A hole must be made in the steel deck using a step-drill, hole saw, deck punch or equivalent in accordance with [Tables 1A, 1C, or 4](#), as applicable. For multi inserts the hole size correlates to the largest internal thread diameter. The Bang-It+ plastic sleeve must be placed in the hole, and following this, the head of the insert must be impacted with sufficient force to compress the outer spring and drive the flared plastic fins of the sleeve completely through the hole in the steel deck. The Bang-It+ base plate may also be attached to the topside of decking for additional stability (optional). Before or after Bang-It+ insertion in deck, a threaded rod or bolt element must be inserted through the perforated nozzle on the end of the plastic sleeve until contact is made with the internally threaded steel body. The threaded rod or bolt element must then be turned into the internal threads of the steel body, or pushed in for Push-In thread, until fully seated in the insert. The threaded steel rod or bolt element must have a minimum thread engagement equal to one steel element diameter. The end of the plastic sleeve must be cut, trimmed, or otherwise removed to the surface of the internally threaded steel body following the concrete pour if the insert is intended to resist shear loads. Bang-It+ inserts are permitted to be installed in either the upper or lower flute of the steel deck.

Installation of Wood-Knocker II+, Pan-Knocker II+, and Bang-It+ inserts must be in accordance with this evaluation report and the manufacturer's printed installation instruction (MPII) as provided in [Figure 8](#) of this report. In the event of a conflict between this report and the MPII, this report governs.

#### 4.4 Special Inspection:

Periodic special inspection is required in accordance with Section 1705.1.1 and Table 1705.3 of the 2024 IBC. The special inspector must make periodic inspections during installation of the headed cast-in specialty inserts to verify insert type, insert dimensions, concrete type, concrete compressive strength, insert spacing, edge distances, concrete member thickness, insert embedment, threaded rod fully seated into insert, and adherence to the manufacturer's printed installation instructions. The special inspector must be present as often as required in accordance with the "statement of special inspection." Under the IBC, additional requirements as set forth in Sections 1705, 1706 and 1707 must be observed, where applicable.

### 5.0 CONDITIONS OF USE:

The Wood-Knocker II+, Pan-Knocker II+, and Bang-It+ concrete anchors described in this report are acceptable alternatives to what is specified in the codes listed in Section 1.0 of this report, subject to the following conditions:

- 5.1 Specialty inserts are limited to dry interior locations.
- 5.2 Specialty insert sizes, dimensions, minimum embedment depths, and other installation parameters are as set forth in this report.
- 5.3 Specialty inserts must be installed in accordance with the manufacturer's printed instructions and this report. In case of conflict, this report governs.
- 5.4 Specialty inserts must be limited to use in cracked and uncracked normal-weight concrete, sand-lightweight concrete and all-lightweight concrete having a specified compressive strength,  $f'_c$ , of 2,500 psi to 10,000 psi (17.2 MPa to 68.9 MPa) for the Wood-Knocker inserts, and in cracked and uncracked normal-weight or sand-lightweight concrete filled steel deck assemblies having a specified compressive strength,  $f'_c$ , of 2,500 psi to 10,000 psi (17.2 MPa to 68.9 MPa) for the Bang-It+ inserts.
- 5.5 The values of  $f'_c$  used for calculation purposes must not exceed 10,000 psi (68.9 MPa).
- 5.6 Strength design values must be established in accordance with Section 4.1 of this report.
- 5.7 Allowable design values are established in accordance with Section 4.2.
- 5.8 Specialty insert spacing and edge distance as well as minimum member thickness must comply with ACI 318-19 Section 17.9 for cast-in-place headed anchors.
- 5.9 Prior to installation, calculations and details demonstrating compliance with this report must be submitted to the code official. The calculations and details must be prepared by a registered design professional where required by the statutes of the jurisdiction in which the project is to be constructed.
- 5.10 Since an ICC-ES acceptance criteria for evaluating data to determine the performance of the specialty inserts subjected to fatigue or shock loading is unavailable at this time, the use of these inserts under such conditions is beyond the scope of this report.
- 5.11 Specialty inserts may be installed in regions of concrete where analysis indicates cracking may occur ( $f_t > f_r$ ), subject to the conditions of this report.
- 5.12 Specialty inserts may be used to resist short-term loading due to wind or seismic forces in locations designated as Seismic Design Categories A through F of the IBC, subject to the conditions of this report.
- 5.13 Where not otherwise prohibited in the code, Wood-Knocker II+, Pan-Knocker II+, and Bang-It+ inserts are permitted for use with fire-resistance-rated construction provided that at least one of the following conditions is fulfilled:
  - Headed cast-in specialty inserts that support a fire-resistance-rated envelope or a fire-resistance-rated membrane are protected by approved fire-resistance-rated materials, or have been evaluated for resistance to fire exposure in accordance with recognized standards.
  - Headed cast-in specialty inserts are used to resist wind or seismic forces only.
  - Headed cast-in specialty inserts are used to support nonstructural elements.
- 5.14 Use of zinc-coated carbon steel anchors is limited to dry, interior locations.
- 5.15 Special inspection must be provided in accordance with Section 4.4.
- 5.16 Specialty inserts are manufactured under an approved quality control program with inspections by ICC-ES.

## 6.0 EVIDENCE SUBMITTED

Data in accordance with the [ICC-ES Acceptance Criteria for Headed Cast-in Specialty Inserts in Concrete AC446 \(24\)](#), published April 2025; and quality control documentation.

## 7.0 IDENTIFICATION

- 7.1 The inserts are identified by packaging labeled with the insert size, lot number, company name, insert name, and evaluation report number (ESR-3657). The inserts have the letters DEWALT or the product name, as applicable, and the nominal size(s) embossed atop the head of the insert, visible prior to installation for verification.
- 7.2 The report holder's contact information is the following:

**DEWALT**  
**701 EAST JOPPA ROAD**  
**TOWSON, MARYLAND 21286**  
**(800) 524-3244**  
[www.DEWALT.com](http://www.DEWALT.com)  
[anchors@DEWALT.com](mailto:anchors@DEWALT.com)

TABLE A—DESIGN USE AND REPORT TABLE INDEX

DESIGN STRENGTH <sup>1</sup>		WOOD-KNOCKER II+ FORM INSERTS			PAN-KNOCKER II+ FORM INSERTS			BANG-IT+ STEEL DECK INSERTS			THREADED STEEL ELEMENTS
		Single Thread-In	Multi Thread	Push-In Thread	Single Thread-In	Multi Thread	Push-In Thread	Single Thread-In	Multi Thread	Push-In Thread	
Steel	$N_{sa}, V_{sa}$	<a href="#">Table 2A</a>	<a href="#">Table 2B</a>	<a href="#">Table 5A</a>	<a href="#">Table 2A</a>	<a href="#">Table 2B</a>	<a href="#">Table 5A</a>	<a href="#">Table 3A</a>	<a href="#">Table 3B</a>	<a href="#">Table 5B</a>	<a href="#">Table 7</a>
Concrete	$N_{cb}, N_{cbg}$	<a href="#">Table 2A</a>	<a href="#">Table 2B</a>	<a href="#">Table 5A</a>	<a href="#">Table 2A</a>	<a href="#">Table 2B</a>	<a href="#">Table 5A</a>	<a href="#">Table 3A</a>	<a href="#">Table 3B</a>	<a href="#">Table 5B</a>	N/A
	$V_{cb}, V_{cbg}, V_{cp}, V_{cpg}$	N/A									N/A

CONCRETE TYPE	CONCRETE STATE	INSERT / STEEL ELEMENT NOMINAL SIZE	SEISMIC DESIGN CATEGORIES <sup>2</sup>
Normal-weight and lightweight	Cracked	1/4", 3/8", M10, M12, 1/2", 5/8", 3/4"	A through F
	Uncracked	1/4", 3/8", M10, M12, 1/2", 5/8", 3/4"	A and B

For SI: 1 inch = 25.4 mm. For pound-inch units: 1 mm = 0.03937 inch.

N/A = Not applicable.

<sup>1</sup>Reference ACI 318-19 Section 17.5.1.3. The controlling strength is decisive from all appropriate failure modes (i.e. steel, concrete, and pryout, as applicable) and design assumptions. The pullout strength in tension and side-face blowout strength in tension is not decisive for design and does not need to be evaluated.

<sup>2</sup>See Section 4.1.8 for requirements for seismic design, where applicable.

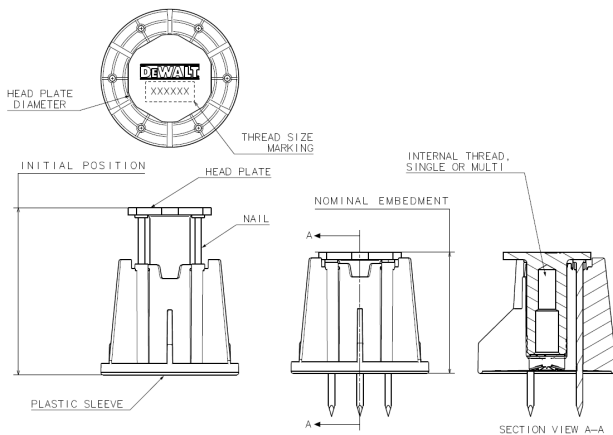

**FIGURE 1A— WOOD-KNOCKER II+ CAST-IN-PLACE INSERTS FOR FORM POUR CONCRETE**  
 Before Setting (head plate and nails starting in initial position) & After Setting (head plate in down position, nails into form)

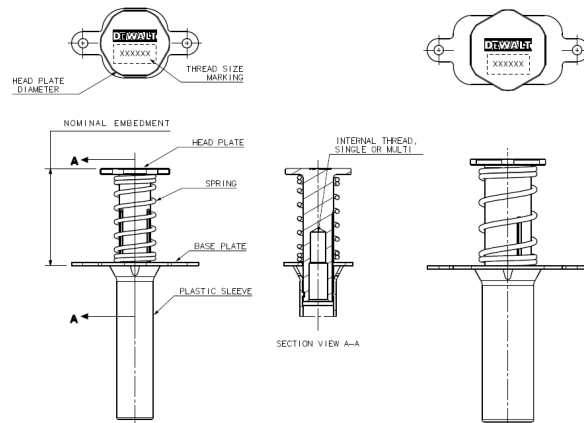

**FIGURE 2—BANG-IT+ CAST-IN-PLACE INSERTS FOR CONCRETE FILLED STEEL DECK FLOOR AND ROOF ASSEMBLIES**

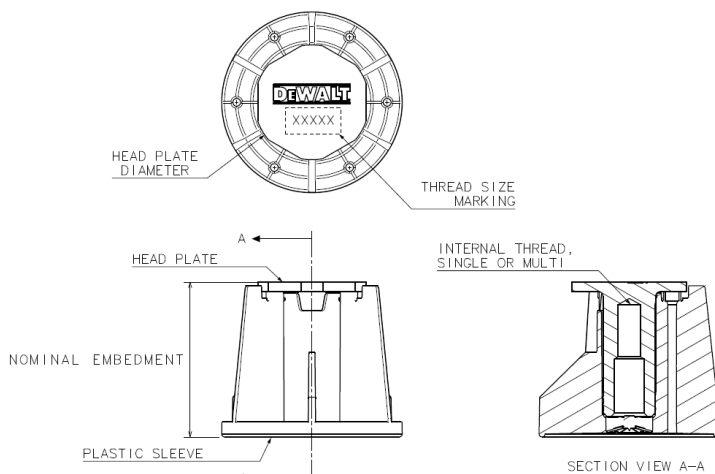

**FIGURE 1B— PAN-KNOCKER II+ CAST-IN-PLACE INSERTS FOR FORM POUR CONCRETE**  
 'No Nail' version of Wood-Knocker II+ (head plate in down position)



TABLE 1A—INSTALLATION SPECIFICATIONS FOR SINGLE THREAD CONCRETE INSERTS<sup>1,2</sup>

SINGLE THREAD INSERT DIMENSIONS	SYMBOL	UNITS	WOOD-KNOCKER II+ AND PAN-KNOCKER II+ NOMINAL INSERT / ANCHOR SIZE						BANG-IT+ NOMINAL INSERT / ANCHOR SIZE							
			<sup>1</sup> / <sub>4</sub> -inch (LP)	<sup>3</sup> / <sub>8</sub> -inch (LP)	<sup>1</sup> / <sub>4</sub> -inch	<sup>3</sup> / <sub>8</sub> -inch	M10	M12	<sup>1</sup> / <sub>2</sub> -inch	<sup>5</sup> / <sub>8</sub> -inch	<sup>3</sup> / <sub>4</sub> -inch	<sup>1</sup> / <sub>4</sub> -inch	<sup>3</sup> / <sub>8</sub> -inch	M10	M12	<sup>1</sup> / <sub>2</sub> -inch
Outside diameter of the steel insert body	$d_a$	in. (mm)	0.5 (13)		0.7 (18)		1.0 (25)		0.7 (18)		1.0 (25)					
Insert head plate diameter	$d_{hp}$	in. (mm)	1.30 (33)		1.50 (38)		1.75 (45)		1.50 (38)		1.75 (45)					
Plastic sleeve diameter	$d_s$	in. (mm)	2 (51)		2-3/8 (60)				27/32 (21)		1-7/32 (31)					
Suggested hole size in deck	$d_{hole}$	in. (mm)	Not applicable						7/8 (22)		1-1/4 (32)					
Base plate width	$w_{bp}$	in. (mm)	Not applicable						1-1/2 (38)							
Nominal embedment depth	$h_{nom}$	in. (mm)	1-1/2 (38)		2 (51)				2 (51)							
Effective embedment depth	$h_{ef}$	in. (mm)	1.25 (32)		1.75 (45)				1.75 (45)							
Minimum member thickness	$h_{min}$	in. (mm)	2-1/2 (64)		3-1/2 (89)				See Figures 4A, 4B and 4C, as applicable							
Minimum spacing distance	$s_{min}$	in. (mm)	4 $d_a$						3 $h_{ef}$ for lower flute locations; 4 $d_a$ for upper flute locations							
Minimum edge distance	$c_{min}$	in. (mm)	0.5 $d_{hp}$ + 3/4 (19)						See Figures 4A, 4B and 4C for lower flute edge distances; otherwise use 0.5 $d_{hp}$ + 3/4 (19)							

For SI: 1 inch = 25.4 mm. For pound-inch unit: 1 mm = 0.03937 inches.

TABLE 1B—INSTALLATION SPECIFICATIONS FOR MULTI THREAD WOOD KNOCKER II+ AND PAN-KNOCKER II+ INSERTS<sup>1</sup>

MULTI THREAD INSERT DIMENSIONS	SYMBOL	UNITS	NOMINAL INSERT / ANCHOR SIZE									
			<sup>1</sup> / <sub>4</sub> & <sup>3</sup> / <sub>8</sub> -inch Multi (LP)	<sup>1</sup> / <sub>4</sub> & <sup>3</sup> / <sub>8</sub> -inch Multi	<sup>1</sup> / <sub>4</sub> & <sup>3</sup> / <sub>8</sub> & <sup>1</sup> / <sub>2</sub> -inch Multi	<sup>3</sup> / <sub>8</sub> & <sup>1</sup> / <sub>2</sub> -inch Multi	M10 & M12 Multi	<sup>3</sup> / <sub>8</sub> & <sup>1</sup> / <sub>2</sub> & <sup>5</sup> / <sub>8</sub> -inch Multi	<sup>5</sup> / <sub>8</sub> & <sup>3</sup> / <sub>4</sub> -inch Multi			
Outside diameter of the steel insert body	$d_a$	in. (mm)	0.5 (13)		0.7 (18)		1.0 (25)					
Insert head plate diameter	$d_{hp}$	in. (mm)	1.30 (33)		1.50 (38)		1.75 (45)					
Plastic sleeve diameter	$d_s$	in. (mm)	2 (51)		2-3/8 (60)		2-3/8 (60)					
Nominal embedment depth	$h_{nom}$	in. (mm)	1-1/2 (38)		2 (51)		2-3/8 (60)					
Effective embedment depth	$h_{ef}$	in. (mm)	1.25 (32)		1.75 (45)		2.25 (57)					
Minimum member thickness	$h_{min}$	in. (mm)	2-1/2 (64)		3-1/2 (89)		3-1/2 (89)					
Minimum spacing distance	$s_{min}$	in. (mm)	4 $d_a$									
Minimum edge distance	$c_{min}$	in. (mm)	0.5 $d_{hp}$ + 3/4 (19)									

For SI: 1 inch = 25.4 mm. For pound-inch unit: 1 mm = 0.03937 inches.

TABLE 1C—INSTALLATION SPECIFICATIONS FOR MULTI THREAD BANG-IT+ INSERTS<sup>1</sup>

MULTI THREAD INSERT DIMENSIONS	SYMBOL	UNITS	NOMINAL INSERT / ANCHOR SIZE									
			<sup>1</sup> / <sub>4</sub> & <sup>3</sup> / <sub>8</sub> -inch Multi	<sup>1</sup> / <sub>4</sub> & <sup>3</sup> / <sub>8</sub> & <sup>1</sup> / <sub>2</sub> -inch Multi	<sup>3</sup> / <sub>8</sub> & <sup>1</sup> / <sub>2</sub> -inch Multi	M10 & M12 Multi	<sup>3</sup> / <sub>8</sub> & <sup>1</sup> / <sub>2</sub> & <sup>5</sup> / <sub>8</sub> -inch Multi	<sup>5</sup> / <sub>8</sub> & <sup>3</sup> / <sub>4</sub> -inch Multi				
Outside diameter of the steel insert body	$d_a$	in. (mm)			0.7 (18)		1.0 (25)					
Insert head plate diameter	$d_{hp}$	in. (mm)			1.50 (38)		1.75 (45)					
Plastic sleeve diameter	$d_s$	in. (mm)			27/32 (21)		1-7/32 (31)					
Suggested hole size in deck	$d_{hole}$	in. (mm)			7/8 (22)		1-1/4 (32)					
Base plate width	$w_{bp}$	in. (mm)			1-1/2 (38)		1-1/2 (38)					
Nominal embedment depth	$h_{nom}$	in. (mm)			2 (51)		2-3/8 (60)					
Effective embedment depth	$h_{ef}$	in. (mm)			1.75 (45)		2.25 (57)					
Minimum member thickness	$h_{min}$	in. (mm)	See Figures 4A, 4B and 4C, as applicable									
Minimum spacing distance	$s_{min}$	in. (mm)	3 $h_{ef}$ for lower flute locations; 4 $d_a$ for upper flute locations									
Minimum edge distance	$c_{min}$	in. (mm)	See Figures 4A, 4B and 4C for lower flute edge distances; otherwise use 0.5 $d_{hp}$ + 3/4 (19)									

For SI: 1 inch = 25.4 mm. For pound-inch unit: 1 mm = 0.03937 inches.

Footnotes for Table 1A, 1B and 1C:

<sup>1</sup>Inserts have internal thread size designations for coarse threads matching the nominal rod / anchor size.

<sup>2</sup>For installation specifications of Push-In thread inserts see Table 4 of this report.

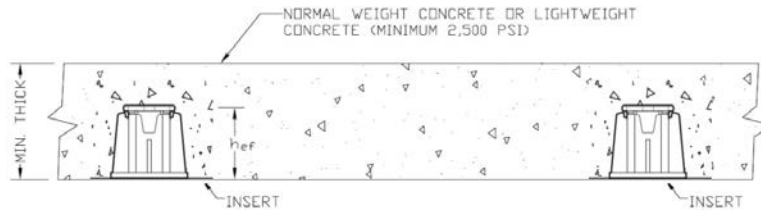

**FIGURE 3—WOOD-KNOCKER II+ OR PAN KNOCKER II+ INSERTS INSTALLED IN FORM POUR CONCRETE FLOOR AND ROOF ASSEMBLIES**

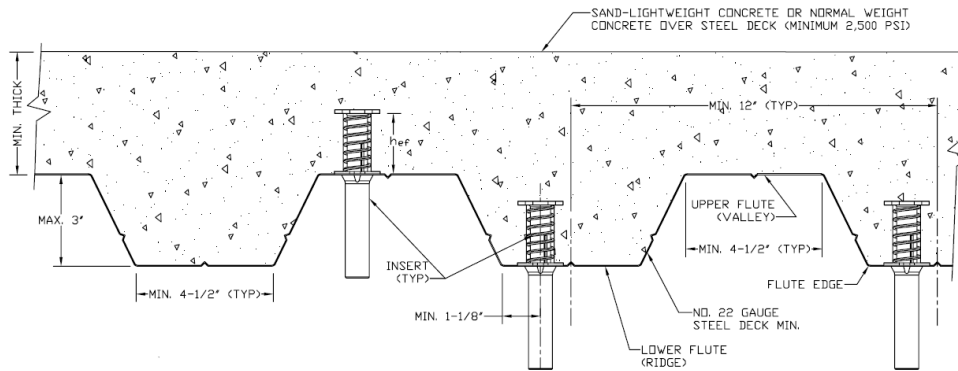

**FIGURE 4A—BANG-IT+ INSERTS INSTALLED IN SOFFIT OF CONCRETE-FILLED STEEL DECK FLOOR AND ROOF ASSEMBLIES<sup>1,2,3,4,5</sup>**

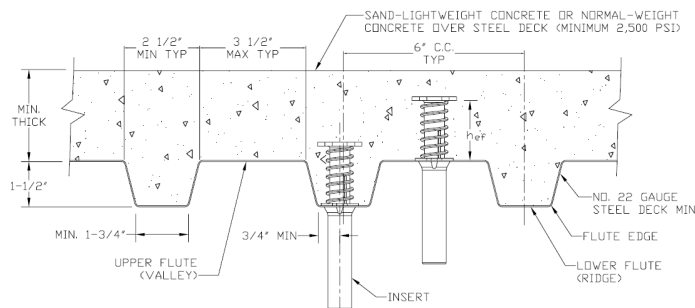

**FIGURE 4B—BANG-IT+ INSERTS INSTALLED IN SOFFIT OF CONCRETE-FILLED STEEL DECK FLOOR AND ROOF ASSEMBLIES<sup>1,2,3,5,6,7</sup>**

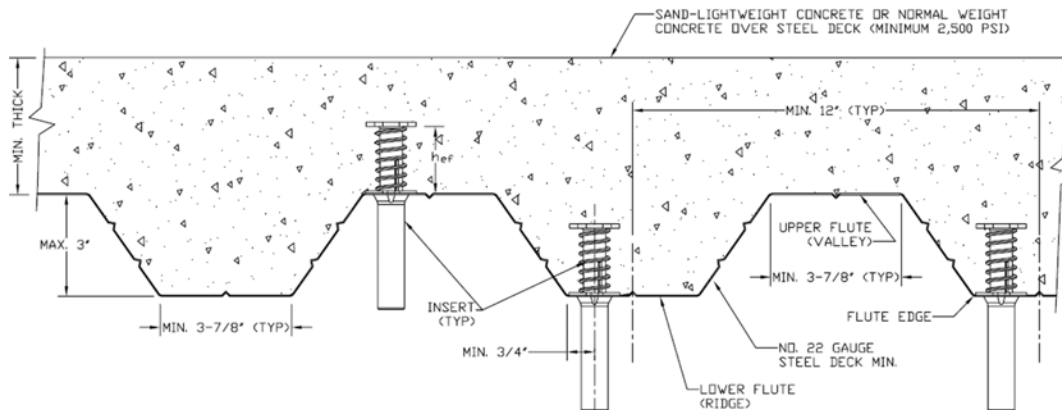

**FIGURE 4C—BANG-IT+ INSERTS INSTALLED IN SOFFIT OF CONCRETE-FILLED STEEL DECK FLOOR AND ROOF ASSEMBLIES<sup>1,2,3,8,9</sup>**

<sup>1</sup>Inserts may be placed in the upper flute or lower flute of the steel deck assembly. Inserts in the lower flute require a minimum 1.5" of concrete topping thickness (min. thick in Figures) from the top of the upper flute, except for the 3/8" & 1/2" & 5/8-inch multi insert and 5/8" & 3/4-inch multi insert which require a minimum of 2" of concrete topping thickness. Upper flute installations require a minimum 3" concrete topping thickness from the top of the upper flute (Fig. 4A, 4B and 4C).

<sup>2</sup>Axial spacing for inserts along the upper flute length shall be 4d<sub>s</sub> minimum; axial spacing along the lower flute length shall be 3h<sub>ef</sub> minimum (Fig. 4A, 4B and 4C).

<sup>3</sup>Upper flute inserts are not subject to steel deck dimension limitations, or the minimum steel deck gauge limitations.

<sup>4</sup>Inserts in the lower flute of Figure 4A may be installed with a maximum 1 1/8-inch offset in either direction from the center of the flute. The offset distance may be increased for flute widths greater than those shown provided the minimum lower flute edge distance of 1 1/8-inch is also satisfied.

<sup>5</sup>Inserts in the lower flute of Figure 4B may be installed with a maximum 1/8-inch offset in either direction from the center of the flute. The offset distance may be increased for flute widths greater than those shown provided the minimum lower flute edge distance of 3/4-inch is also satisfied.

<sup>6</sup>Lower flute installations of Figure 4B with flutes widths greater than 1 3/4-inch are permitted.

<sup>7</sup>Lower flute installations of Figure 4B in flute depths greater than 1 1/2-inch are permitted provided the minimum edge distance of 3/4-inch is met and the minimum lower flute width is increased proportionally (e.g. applicable to a lower flute depth of 2-inch with a minimum lower flute width of 2 1/4-inch).

<sup>8</sup>Inserts in the lower flute of Figure 4C may be installed with a maximum 1 3/16-inch offset in either direction from the center of the flute.

<sup>9</sup>Inserts in upper flute may be installed anywhere across upper flute provided minimum edge distances are maintained; see Tables 1A, 1C and 5B as applicable.

TABLE 2A—DESIGN INFORMATION FOR WOOD KNOCKER II+ AND PAN-KNOCKER II+ SINGLE THREAD INSERTS<sup>1,2,3,4,5</sup>

DESIGN INFORMATION / INSERT PROPERTY	SYMBOL	UNITS	1/4-inch (LP)	3/8-inch (LP)	1/4-inch	3/8-inch	M10	M12	1/2-inch	5/8-inch	3/4-inch
Outside diameter of the steel insert body	$d_a$	in. (mm)	0.5 (13)				0.7 (18)				1.0 (25)
Insert head plate net bearing area	$A_{brg}$	in <sup>2</sup> (mm <sup>2</sup> )	1.00 (645)				1.20 (762)				1.40 (903)
Effective embedment depth	$h_{ef}$	in. (mm)	1.25 (32)				1.75 (45)				1.75 (45)
<b>STEEL STRENGTH IN TENSION (ACI 318-19 Section 17.6.1)</b>											
Steel strength in tension of single insert	$N_{sa,insert}$	lb (kN)	3,545 (15.8)	6,535 (29.1)	3,545 (15.8)		9,005 (40.1)				12,685 (56.4)
Steel strength in tension of single insert, seismic	$N_{sa,insert,eq}$	lb (kN)	3,545 (15.8)	6,535 (29.1)	3,545 (15.8)		9,005 (40.1)				12,685 (56.4)
Reduction factor, steel strength in tension	$\phi$	-	0.65			0.65			0.65		
<b>CONCRETE BREAKOUT STRENGTH IN TENSION (ACI 318-19 Section 17.6.2)</b>											
Effectiveness factor for cracked concrete	$k_c$	-	24 (for SI use a value of 10)								
Modification factor for uncracked concrete	$\psi_{C,N}$	-	1.25								
Reduction factor, concrete strength in tension	$\phi$	-	0.70								
<b>STEEL STRENGTH IN SHEAR (ACI 318-19 Section 17.7.1)</b>											
Steel strength in shear of single insert	$V_{sa,insert}$	lb (kN)	985 (4.4)	2,835 (12.6)	1,775 (7.9)	4,220 (18.8)	7,180 (31.9)				9,075 (40.4)
Steel strength in shear of single insert, seismic	$V_{sa,insert,eq}$	lb (kN)	385 (1.7)	625 (2.8)	1,775 (7.9)	4,220 (18.8)	7,180 (31.9)				9,075 (40.4)
Reduction factor, steel strength in shear	$\phi$	-	0.60			0.60			0.60		
<b>CONCRETE BREAKOUT STRENGTH IN SHEAR (ACI 318-19 Section 17.7.2) AND PRYOUT STRENGTH IN SHEAR (ACI 318-19 Section 17.7.3)</b>											
Load bearing length of insert	$\ell_e$	in. (mm)	1.25 (32)				1.75 (45)				1.75 (45)
Reduction factor, concrete strength in shear	$\phi$	-	0.70			0.70			0.70		
Coefficient for prying strength	$k_{cp}$	-	1			1			1		
Reduction factor, prying strength in shear	$\phi$	-	0.70			0.70			0.70		

For SI: 1 inch = 25.4 mm, 1 pound = 0.00445 kN, 1 psi = 0.006895 MPa. For pound-inch unit: 1 mm = 0.03937 inches.

TABLE 2B—DESIGN INFORMATION FOR WOOD KNOCKER II+ AND PAN-KNOCKER II+ MULTI THREAD INSERTS<sup>1,2,3,4,5</sup>

DESIGN INFORMATION / INSERT PROPERTY	SYMBOL	UNITS	1/4 & 3/8		1/4 & 3/8		1/4 & 3/8 & 1/2			3/8 & 1/2		M10 & M12			3/8 & 1/2 & 5/8			5/8 & 3/4	
			Multi (LP)	Multi	Multi	Multi	Multi	Multi	Multi	Multi	Multi	Multi	Multi	Multi	Multi	Multi	Multi	Multi	Multi
			1/4- inch	3/8- inch	1/4- inch	3/8- inch	1/4- inch	3/8- inch	1/2- inch	3/8- inch	1/2- inch	M10	M12	3/8- inch	1/2- inch	5/8- inch	5/8- inch	3/4- inch	
Outside diameter of the steel insert body	$d_a$	in. (mm)	0.5 (13)						0.7 (18)									1.0 (25)	
Insert head plate net bearing area	$A_{brg}$	in <sup>2</sup> (mm <sup>2</sup> )	1.00 (645)						1.20 (762)									1.40 (903)	
Effective embedment depth	$h_{ef}$	in. (mm)	1.25 (32)						1.75 (45)									2.25 (57)	
<b>STEEL STRENGTH IN TENSION (ACI 318-19 Section 17.6.1)</b>																			
Steel strength in tension of single insert	$N_{sa,insert}$	lb (kN)	3,545 (15.8)	6,535 (29.1)	3,085 (13.7)	9,005 (40.1)	3,545 (15.8)	7,515 (33.4)	9,005 (40.1)	9,005 (40.1)	9,005 (40.1)	9,005 (40.1)	9,005 (40.1)	9,005 (40.1)	8,630 (38.4)	16,610 (73.9)		17,100 (76.1)	
Steel strength in tension of single insert, seismic	$N_{sa,insert,eq}$	lb (kN)	3,545 (15.8)	6,535 (29.1)	3,085 (13.7)	9,005 (40.1)	3,545 (15.8)	7,515 (33.4)	9,005 (40.1)	9,005 (40.1)	9,005 (40.1)	9,005 (40.1)	9,005 (40.1)	9,005 (40.1)	8,630 (38.4)	16,610 (73.9)		17,100 (76.1)	
Reduction factor, steel strength in tension	$\phi$	-	0.65			0.65			0.65			0.65			0.65				
<b>CONCRETE BREAKOUT STRENGTH IN TENSION (ACI 318-19 Section 17.6.2)</b>																			
Effectiveness factor for cracked concrete	$k_c$	-	24 (for SI use a value of 10)																
Modification factor for uncracked concrete	$\psi_{C,N}$	-	1.25																
Reduction factor, concrete strength in tension	$\phi$	-	0.70																
<b>STEEL STRENGTH IN SHEAR (ACI 318-19 Section 17.7.1)</b>																			
Steel strength in shear of single insert	$V_{sa,insert}$	lb (kN)	985 (4.4)	2,835 (12.6)	910 (4.1)	4,220 (18.8)	1,775 (7.9)	4,220 (18.8)	7,180 (31.9)	3,475 (15.5)	7,180 (31.9)	3,475 (15.5)	7,180 (31.9)	3,720 (16.6)	9,410 (41.9)	10,570 (47.0)		10,965 (48.8)	
Steel strength in shear of single insert, seismic	$V_{sa,insert,eq}$	lb (kN)	385 (1.7)	625 (2.8)	365 (1.6)	4,220 (18.8)	480 (2.1)	715 (3.2)	7,180 (31.9)	695 (3.1)	7,180 (31.9)	695 (3.1)	7,180 (31.9)	1,080 (4.8)	4,705 (20.9)	10,570 (47.0)	4,385 (19.1)	10,965 (48.8)	
Reduction factor, steel strength in shear	$\phi$	-	0.60			0.60			0.60			0.60			0.60				
<b>CONCRETE BREAKOUT STRENGTH IN SHEAR (ACI 318-19 Section 17.7.2) AND PRYOUT STRENGTH IN SHEAR (ACI 318-19 Section 17.7.3)</b>																			
Load bearing length of insert	$\ell_e$	in. (mm)	1.25 (32)						1.75 (45)									2.25 (57)	
Reduction factor, concrete strength in shear	$\phi$	-	0.70			0.70			0.70			0.70			0.70				
Coefficient for prying strength	$k_{cp}$	-	1			1			1			1			1				
Reduction factor, prying strength in shear	$\phi$	-	0.70			0.70			0.70			0.70			0.70				

For SI: 1 inch = 25.4 mm, 1 pound = 0.00445 kN, 1 psi = 0.006895 MPa. For pound-inch unit: 1 mm = 0.03937 inches.

**Footnotes for Table 2A and 2B:**

- <sup>1</sup>Concrete must have a compressive strength  $f'_c$  of 2,500 psi minimum. Installation must comply with Sections 4.1.10 and 4.3, and Figure 3 of this report.
- <sup>2</sup>Design of headed cast-in specialty inserts shall be in accordance with the provisions of ACI 318-19 Chapter 17 for cast-in headed anchors. Concrete breakout strength must also be in accordance with Figure 3.
- <sup>3</sup>The strength reduction factor applies when the load combinations from the IBC or ACI 318-19 are used and the requirements of ACI 318-19 Section 17.5.3 are met. Strength reduction values correspond to brittle steel elements; see Section 3.2.2 of this report.
- <sup>4</sup>Minimum spacing distance between anchors and minimum edge distance for cast-in headed Wood Knocker II+ and Pan-Knocker II+ anchors shall be in accordance with ACI 318-19 Section 17.9; see installation tables for additional details.
- <sup>5</sup>The strengths shown in the table are for inserts only. Design professional is responsible for checking threaded rod or bolt strength in tension, shear, and combined tension and shear, as applicable. See Table 7 for steel design information for common threaded rod elements.

TABLE 3A—DESIGN INFORMATION FOR BANG-IT+ SINGLE THREAD INSERTS<sup>1,2,3,4,5,6</sup>

DESIGN INFORMATION / INSERT PROPERTY		SYMBOL	UNITS	1/4-inch	3/8-inch	M10	M12	1/2-inch	5/8-inch	3/4-inch	
Outside diameter of the steel insert body)		$d_a$	in. (mm)			0.7 (18)				1.0 (25)	
Insert head net bearing area		$A_{brg}$	in <sup>2</sup> (mm <sup>2</sup> )			1.20 (762)				1.40 (903)	
Effective embedment depth		$h_{ef}$	in. (mm)			1.75 (45)				1.75 (45)	
<b>STEEL STRENGTH IN TENSION (ACI 318-19 Section 17.6.1)</b>											
According to Figures 4A, 4B & 4C	Steel strength in tension of single insert	$N_{sa,insert}$	lb (kN)	3,955 (17.6)	9,480 (42.2)		9,850 (43.8)			11,985 (53.3)	
	Steel strength in tension of single insert, seismic	$N_{sa,insert,eq}$	lb (kN)	3,955 (17.6)	9,480 (42.2)		9,850 (43.8)			11,985 (53.3)	
Reduction factor, steel strength in tension		$\phi$	-				0.65			0.65	
<b>CONCRETE BREAKOUT STRENGTH IN TENSION (ACI 318-19 Section 17.6.2)</b>											
Effectiveness factor for cracked concrete		$k_c$	-				24	(for SI use a value of 10)			
Modification factor for uncracked concrete		$\psi_{C,N}$	-				1.25				
Reduction factor, concrete strength in tension		$\phi$	-				0.70				
<b>STEEL STRENGTH IN SHEAR (ACI 318-19 Section 17.7.1)</b>											
According to Figure 4A	Steel strength in shear of single insert	$V_{sa,insert,deck}$	lb (kN)	1,980 (8.8)			2,280 (10.1)			3,075 (13.7)	
	Steel strength in shear of single insert, seismic	$V_{sa,insert,eq,deck}$	lb (kN)	1,980 (8.8)			2,280 (10.1)			2,695 (12.0)	
According to Figures 4B & 4C	Steel strength in shear of single insert	$V_{sa,insert,deck}$	lb (kN)	1,805 (8.0)			2,080 (9.3)			2,975 (13.2)	
	Steel strength in shear of single insert, seismic	$V_{sa,insert,eq,deck}$	lb (kN)	1,805 (8.0)			2,080 (9.3)			2,695 (12.0)	
Reduction factor, steel strength in shear		$\phi$	-	0.60			0.60			0.60	

For SI: 1 inch = 25.4 mm, 1 pound = 4.45 N, 1 psi = 0.006895 MPa. For pound-inch unit: 1 mm = 0.03937 inches.

TABLE 3B— DESIGN INFORMATION FOR BANG-IT+ MULTI THREAD INSERTS<sup>1,2,3,4,5,6</sup>

DESIGN INFORMATION / INSERT PROPERTY		SYMBOL	UNITS	1/4 & 3/8 Multi		1/4 & 3/8 & 1/2 Multi			3/8 & 1/2 Multi		3/8 & 1/2 & 5/8 Multi			5/8 & 3/4 Multi		
				1/4-inch	3/8-inch	1/4-inch	3/8-inch	1/2-inch	3/8-inch	1/2-inch	M10	M12	3/8-inch	1/2-inch	5/8-inch	5/8-inch
Outside diameter of the steel insert body		$d_a$	in. (mm)												1.0 (25)	
Insert head plate net bearing area		$A_{brg}$	in <sup>2</sup> (mm <sup>2</sup> )												1.40 (903)	
Effective embedment depth		$h_{ef}$	in. (mm)												2.25 (57)	
<b>STEEL STRENGTH IN TENSION (ACI 318-19 Section 17.6.1)</b>																
According to Figures 4A, 4B & 4C	Steel strength in tension of single insert	$N_{sa,insert}$	lb (kN)	1,965 (8.7)	9,480 (42.2)	3,545 (15.8)	8,565 (38.1)	9,850 (43.8)	9,480 (42.2)	9,850 (43.8)	9,850 (43.8)	11,485 (51.1)	17,365 (77.2)		20,805 (92.5)	
	Steel strength in tension of single insert, seismic	$N_{sa,insert,eq}$	lb (kN)	1,965 (8.7)	9,480 (42.2)	3,545 (15.8)	8,565 (38.1)	9,850 (43.8)	9,480 (42.2)	9,850 (43.8)	9,850 (43.8)	11,485 (51.1)	17,365 (77.2)		20,805 (92.5)	
Reduction factor, steel strength in tension		$\phi$	-					0.65							0.65	
<b>CONCRETE BREAKOUT STRENGTH IN TENSION (ACI 318-19 Section 17.6.2)</b>																
Effectiveness factor for cracked concrete		$k_c$	-												24 (for SI use a value of 10)	
Modification factor for uncracked concrete		$\psi_{C,N}$	-												1.25	
Reduction factor, concrete strength in tension		$\phi$	-												0.70	
<b>STEEL STRENGTH IN SHEAR (ACI 318-19 Section 17.7.1)</b>																
According to Figure 4A	Steel strength in shear of single insert, in upper flute	$V_{sa,insert,deck}$	lb (kN)	1,670 (7.4)	2,280 (10.2)	1,670 (7.4)	3,545 (15.8)	4,165 (18.5)	2,375 (10.6)	4,165 (18.5)	2,375 (10.6)	4,165 (18.5)	4,875 (21.7)	8,090 (36.0)	5,620 (25.0)	6,475 (28.8)
	Steel strength in shear of single insert, in lower flute	$V_{sa,insert,deck}$	lb (kN)	1,165 (5.2)	2,280 (10.2)	1,275 (5.7)	2,070 (9.2)	2,070 (9.2)	2,080 (9.3)	2,280 (10.2)	2,080 (9.3)	2,280 (10.2)	2,515 (11.2)	2,515 (11.2)		3,045 (13.5)
	Steel strength in shear of single insert, seismic	$V_{sa,insert,eq,deck}$	lb (kN)	395 (1.8)	2,280 (10.2)	395 (1.8)	1,435 (6.4)	1,790 (8.0)	2,080 (9.3)	2,080 (9.3)	2,080 (9.3)	2,080 (9.3)	2,175 (9.7)	2,175 (9.7)		1,905 (8.5)
According to Figures 4B & 4C	Steel strength in shear of single insert, in upper flute	$V_{sa,insert,deck}$	lb (kN)	1,670 (7.4)	2,280 (10.2)	1,670 (7.4)	3,545 (15.8)	4,165 (18.5)	2,375 (10.6)	4,165 (18.5)	2,375 (10.6)	4,165 (18.5)	4,875 (21.7)	8,090 (36.0)	5,620 (25.0)	6,475 (28.8)
	Steel strength in shear of single insert, in lower flute	$V_{sa,insert,deck}$	lb (kN)	1,165 (5.2)	2,080 (9.3)	1,275 (5.7)	1,435 (6.4)	1,790 (8.0)	2,080 (9.3)	2,080 (9.3)	2,080 (9.3)	2,175 (9.7)	2,175 (9.7)		1,905 (8.5)	
	Steel strength in shear of single insert, seismic	$V_{sa,insert,eq,deck}$	lb (kN)	395 (1.8)	2,080 (9.3)	395 (1.8)	1,435 (6.4)	1,790 (8.0)	2,080 (9.3)	2,080 (9.3)	2,080 (9.3)	2,175 (9.7)	2,175 (9.7)		1,905 (8.5)	
Reduction factor, steel strength in shear		$\phi$	-					0.60							0.60	

For SI: 1 inch = 25.4 mm, 1 pound = 4.45 N, 1 psi = 0.006895 MPa. For pound-inch unit: 1 mm = 0.03937 inches.

**Footnotes for Table 3A and 3B:**

- <sup>1</sup>Concrete must have a compressive strength  $f'_c$  of 2,500 psi minimum. Installation must comply with Sections 4.1.10 and 4.3, and Figure 3 of this report.
- <sup>2</sup>Design of headed cast-in specialty inserts shall be in accordance with the provisions of ACI 318-19 Chapter 17 for cast-in headed anchors. Concrete breakout strength must also be in accordance with Figures 4A, 4B and 4C, as applicable.
- <sup>3</sup>The strength reduction factor applies when the load combinations from the IBC or ACI 318-19 are used and the requirements of ACI 318-19 Section 17.5.3 are met. Strength reduction values correspond to brittle steel elements; see Section 3.2.2 of this report for details.
- <sup>4</sup>Minimum spacing distance between anchors and minimum edge distances for cast-in headed Bang-It+ anchors shall be in accordance with Figures 4A, 4B or 4C, as applicable, and noted provisions.
- <sup>5</sup>The tabulated insert strength values are applicable to installations in the lower flute or upper flute of the steel deck profiles; see Figures 4A, 4B and 4C.
- <sup>6</sup>The strengths shown in the table are for inserts only. Design professional is responsible for checking threaded rod strength in tension, shear, and combined tension and shear, as applicable. See Table 7 for steel design information for common threaded rod elements.

TABLE 4—INSTALLATION SPECIFICATIONS FOR PUSH-IN THREAD CONCRETE INSERTS<sup>1</sup>

SINGLE THREAD INSERT DIMENSIONS	SYMBOL	UNITS	WOOD-KNOCKER II+ AND PAN-KNOCKER II+ PUSH-IN NOMINAL INSERT / ANCHOR SIZE		BANG-IT+ PUSH-IN NOMINAL INSERT / ANCHOR SIZE	
			<sup>3</sup> / <sub>8</sub> -inch	<sup>1</sup> / <sub>2</sub> -inch	<sup>3</sup> / <sub>8</sub> -inch	<sup>1</sup> / <sub>2</sub> -inch
Outside diameter of the steel insert body	$d_a$	in. (mm)	1.0 (25)	1.125 (29)	1.0 (25)	1.125 (29)
Insert head plate diameter	$d_{hp}$	in. (mm)	1.9 (48)	2.2 (56)	1.9 (48)	2.2 (56)
Plastic sleeve diameter	$d_s$	in. (mm)	2-3/8 (60)	2-3/8 (60)	1-3/32 (28)	1-7/32 (31)
Suggested hole size in deck	$d_{hole}$	in. (mm)	Not applicable		1-1/4 (32)	1-1/4 (32)
Base plate width	$w_{bp}$	in. (mm)	Not applicable		1-1/2 (38)	
Nominal embedment depth	$h_{nom}$	in. (mm)	1-7/8 (48)	2-3/16 (56)	1-11/16 (43)	1-7/8 (48)
Effective embedment depth	$h_{ef}$	in. (mm)	1.7 (43)	2.0 (51)	1.5 (38)	1.7 (43)
Minimum member thickness	$h_{min}$	in. (mm)	3-1/2 (89)		See <a href="#">Figures 4A</a> , <a href="#">4B</a> and <a href="#">4C</a> , as applicable	
Minimum spacing distance	$s_{min}$	in. (mm)	4 $d_a$		3 $h_{ef}$ for lower flute locations; 4 $d_s$ for upper flute locations	
Minimum edge distance	$c_{min}$	in. (mm)	0.5 $d_{hp}$ + 3/4 (19)		See <a href="#">Figures 4A</a> , <a href="#">4B</a> and <a href="#">4C</a> for lower flute edge distances; otherwise use 0.5 $d_{hp}$ + 3/4 (19)	

For **SI**: 1 inch = 25.4 mm. For **pound-inch unit**: 1 mm = 0.03937 inches.

<sup>1</sup>Inserts have internal thread size designations for coarse threads matching the nominal rod / anchor size.

TABLE 5A—DESIGN INFORMATION FOR WOOD KNOCKER II+ AND PAN-KNOCKER II+ PUSH-IN THREAD INSERTS<sup>1,2,3,4,7</sup>

DESIGN INFORMATION / INSERT PROPERTY	SYMBOL	UNITS	3/8-inch	1/2-inch
Outside diameter of the steel insert body	$d_a$	in. (mm)	1.0 (25)	1.125 (29)
Insert head plate net bearing area	$A_{brg}$	in <sup>2</sup> (mm <sup>2</sup> )	2.0 (1290)	2.7 (1742)
Effective embedment depth	$h_{ef}$	in. (mm)	1.7 (43)	2.0 (51)
<b>STEEL STRENGTH IN TENSION (ACI 318-19 Section 17.6.1)</b>				
Steel strength in tension of single insert	$N_{sa,insert}$	lb (kN)	11,265 (50.1)	17,595 (78.3)
Steel strength in tension of single insert, seismic	$N_{sa,insert,eq}$	lb (kN)	11,265 (50.1)	17,595 (78.3)
Reduction factor, steel strength in tension	$\phi$	-	0.65	0.65
<b>CONCRETE BREAKOUT STRENGTH IN TENSION (ACI 318-19 Section 17.6.2)</b>				
Effectiveness factor for cracked concrete	$k_c$	-	24 (for SI use a value of 10)	
Modification factor for uncracked concrete	$\psi_{C,N}$	-	1.25	
Reduction factor, concrete strength in tension	$\phi$	-	0.70	
<b>STEEL STRENGTH IN SHEAR (ACI 318-19 Section 17.7.1)</b>				
Steel strength in shear of single insert	$V_{sa,insert}$	lb (kN)	3,625 (16.1)	5,955 (26.5)
Steel strength in shear of single insert, seismic	$V_{sa,insert,eq}$	lb (kN)	3,625 (16.1)	5,955 (26.5)
Reduction factor, steel strength in shear	$\phi$	-	0.60	0.60
<b>CONCRETE BREAKOUT STRENGTH IN SHEAR (ACI 318-19 Section 17.7.2) AND PRYOUT STRENGTH IN SHEAR (ACI 318-19 Section 17.7.3)</b>				
Load bearing length of insert	$l_e$	in. (mm)	1.7 (43)	2.0 (51)
Reduction factor, concrete strength in shear	$\phi$	-	0.70	0.70
Coefficient for prout strength	$k_{CP}$	-	1	1
Reduction factor, prout strength in shear	$\phi$	-	0.70	0.70

For **SI**: 1 inch = 25.4 mm, 1 pound = 0.00445 kN, 1 psi = 0.006895 MPa. For **pound-inch unit**: 1 mm = 0.03937 inches.

TABLE 5B—DESIGN INFORMATION FOR BANG-IT+ PUSH-IN THREAD INSERTS<sup>1,2,3,5,6,7</sup>

DESIGN INFORMATION / INSERT PROPERTY	SYMBOL	UNITS	3/8-inch	1/2-inch
Outside diameter of the steel insert body	$d_a$	in. (mm)	1.0 (25)	1.125 (29)
Insert head net bearing area	$A_{brg}$	in <sup>2</sup> (mm <sup>2</sup> )	2.0 (1290)	2.7 (1742)
Effective embedment depth	$h_{ef}$	in. (mm)	1.5 (38)	1.7 (43)
<b>STEEL STRENGTH IN TENSION (ACI 318-19 Section 17.6.1)</b>				
According to <a href="#">Figures 4A, 4B &amp; 4C</a>	Steel strength in tension of single insert	$N_{sa,insert}$	lb (kN)	11,265 (50.1)
	Steel strength in tension of single insert, seismic	$N_{sa,insert,eq}$	lb (kN)	11,265 (50.1)
Reduction factor, steel strength in tension	$\phi$	-	0.65	0.65
<b>CONCRETE BREAKOUT STRENGTH IN TENSION (ACI 318-19 Section 17.6.2)</b>				
Effectiveness factor for cracked concrete	$k_c$	-	24 (for SI use a value of 10)	
Modification factor for uncracked concrete	$\psi_{C,N}$	-	1.25	
Reduction factor, concrete strength in tension	$\phi$	-	0.70	
<b>STEEL STRENGTH IN SHEAR (ACI 318-19 Section 17.7.1)</b>				
According to <a href="#">Figure 4A</a>	Steel strength in shear of single insert, in upper flute	$V_{sa,insert,deck}$	lb (kN)	3,305 (14.7)
	Steel strength in shear of single insert, in lower flute	$V_{sa,insert,deck}$	lb (kN)	2,295 (10.2)
	Steel strength in shear of single insert, seismic	$V_{sa,insert,eq,deck}$	lb (kN)	2,295 (10.2)
According to <a href="#">Figures 4B &amp; 4C</a>	Steel strength in shear of single insert, in upper flute	$V_{sa,insert,deck}$	lb (kN)	3,305 (14.7)
	Steel strength in shear of single insert, in lower flute	$V_{sa,insert,deck}$	lb (kN)	2,295 (10.2)
	Steel strength in shear of single insert, seismic	$V_{sa,insert,eq,deck}$	lb (kN)	2,295 (10.2)
Reduction factor, steel strength in shear	$\phi$	-	0.60	0.60

For **SI**: 1 inch = 25.4 mm, 1 pound = 4.45 N, 1 psi = 0.006895 MPa. For **pound-inch unit**: 1 mm = 0.03937 inches.

**Footnotes for Table 5A and 5B:**

- <sup>1</sup>Concrete must have a compressive strength  $f'_c$  of 2,500 psi minimum. Installation must comply with Sections 4.1.10 and 4.3, and [Figure 3](#) of this report.
- <sup>2</sup>Design of headed cast-in specialty inserts shall be in accordance with the provisions of ACI 318-19 Chapter 17 for cast-in headed anchors. Concrete breakout strength must also be in accordance with [Figures 4A, 4B and 4C](#), as applicable.
- <sup>3</sup>The strength reduction factor applies when the load combinations from the IBC or ACI 318-19 are used and the requirements of ACI 318-19 Section 17.5.3 are met. Strength reduction values correspond to brittle steel elements; see Section 3.2.2 of this report for details.
- <sup>4</sup>Minimum spacing distance between anchors and minimum edge distance for cast-in headed Wood Knocker II+ and Pan-Knocker II+ anchors shall be in accordance with ACI 318-19 Section 17.9; see installation tables for additional details.
- <sup>5</sup>Minimum spacing distance between anchors and minimum edge distances for cast-in headed Bang-It+ anchors shall be in accordance with [Figures 4A, 4B and 4C](#), as applicable, and noted provisions.
- <sup>6</sup>The tabulated insert strength values are applicable to installations in the lower flute or upper flute of the steel deck profiles; see [Figures 4A, 4B and 4C](#).
- <sup>7</sup>The strengths shown in the table are for inserts only. Design professional is responsible for checking threaded rod strength in tension, shear, and combined tension and shear, as applicable. See [Table 7](#) for steel design information for common threaded rod elements.

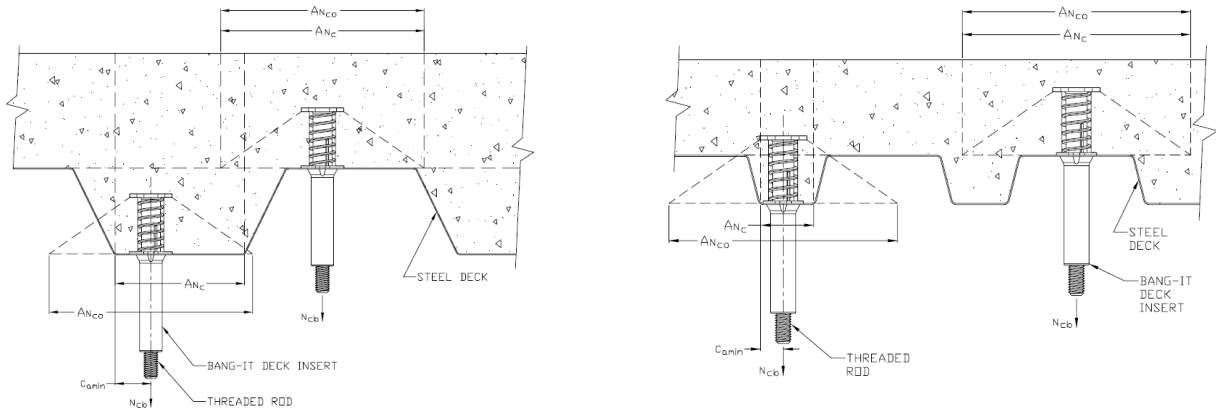

Idealization of Steel Deck Profile (e.g. see Figures 4A and 4C)

Idealization of Steel Deck Profile (e.g. see Figure 4B)

FIGURE 5—IDEALIZATION OF CONCRETE FILLED STEEL DECKS FOR DETERMINATION OF CONCRETE BREAKOUT STRENGTH IN ACCORDANCE WITH ACI 318

TABLE 6—SPECIFICATIONS AND PHYSICAL PROPERTIES OF COMMON CARBON STEEL THREADED ROD ELEMENTS<sup>1</sup>

THREADED ROD SPECIFICATION		UNITS	MIN. SPECIFIED ULTIMATE STRENGTH, $f_{uta}$	MIN. SPECIFIED YIELD STRENGTH 0.2 PERCENT OFFSET, $f_{ya}$	$f_{uta}$ — $f_{ya}$	ELONGATION MINIMUM PERCENT <sup>5</sup>	REDUCTION OF AREA MIN. PERCENT	RELATED NUT SPECIFICATION <sup>7</sup>
Carbon Steel	ASTM A36/A36M <sup>2</sup>	psi (MPa)	58,000 (400)	36,000 (248)	1.61	23	50	ASTM A194 / A563 Grade A
	ISO 898-1 <sup>4</sup> Class 4.6	MPa (psi)	400 (58,000)	240 (34,800)	1.67	22	- <sup>6</sup>	ISO 4032 Grade 4
	ISO 898-1 <sup>4</sup> Class 8.8	MPa (psi)	800 (116,000)	640 (92,800)	1.25	12	- <sup>6</sup>	ISO 4032 Grade 8
	ASTM A193/A193M <sup>3</sup> Grade B7	psi (MPa)	125,000 (860)	105,000 (720)	1.19	16	50	ASTM A194 / A563 Grade DH

For SI: 1 inch = 25.4 mm, 1 psi = 0.006897 MPa. For pound-inch units: 1 mm = 0.03937 inch, 1 MPa = 145.0 psi.

<sup>1</sup>Inserts may be used in conjunction with all grades of continuously threaded carbon steels (all-thread) that comply with code reference standards and that have thread characteristics comparable with ANSI B1.1 UNC Coarse Thread Series or ANSI B1.13M M Profile Metric Coarse Thread Series. Tabulated values correspond to anchor diameters included in this report. See Section 3.2.2 of this report for ductility of steel anchor elements.

<sup>2</sup>Standard Specification for Carbon Structural Steel.

<sup>3</sup>Standard Specification for Alloy-Steel and Stainless Steel Bolting Materials for High Temperature or High Pressure Service and Other Special Purpose Applications.

<sup>4</sup>Mechanical properties of fasteners made of carbon steel and alloy steel – Part 1: Bolts, screws and studs.

<sup>5</sup>Based on 2-inch (50 mm) gauge length except for ASTM A36/A36M and ASTM A193/A193M, which are based on a gauge length of 4d.

<sup>6</sup>Minimum percent reduction of area not reported in the referenced standard.

<sup>7</sup>Where nuts are applicable, nuts of other grades and style having specified proof load stress greater than the specified grade and style are also suitable.

TABLE 7—STEEL DESIGN INFORMATION FOR COMMON THREADED ROD ELEMENTS USED WITH CONCRETE INSERTS<sup>1,2,3,4</sup>

DESIGN INFORMATION	SYMBOL	UNITS	1/4-inch	3/8-inch	M10	M12	1/2-inch	5/8-inch	3/4-inch	
Threaded rod nominal outside diameter	$d_{rod}$	in. (mm)	0.250 (6.4)	0.375 (9.5)	0.394 (10)	0.472 (12)	0.500 (12.7)	0.625 (15.9)	0.750 (19.1)	
Threaded rod effective cross-sectional area	$A_{se}$	in <sup>2</sup> (mm <sup>2</sup> )	0.032 (21)	0.078 (50)	0.090 (58)	0.131 (85)	0.142 (92)	0.226 (146)	0.335 (216)	
Steel strength in tension of threaded rod	ASTM A36	$N_{sa,rod,A36}$	lb (kN)	1,855 (8.2)	4,525 (20.0)	5,220 (23.2)	7,600 (33.8)	8,235 (36.6)	13,110 (58.3)	19,400 (86.3)
Steel strength in tension of threaded rod, seismic			lb (kN)	1,855 (8.2)	4,525 (20.0)	5,220 (23.2)	7,600 (33.8)	8,235 (36.6)	13,110 (58.3)	19,400 (86.3)
Steel strength in tension of threaded rod	ASTM A193, Grade B7	$N_{sa,rod,B7}$	lb (kN)	4,000 (17.7)	9,750 (43.1)	11,250 (50.1)	16,375 (72.9)	17,750 (78.9)	28,250 (125.7)	41,875 (186.0)
Steel strength in tension of threaded rod, seismic			lb (kN)	4,000 (17.7)	9,750 (43.1)	11,250 (50.1)	16,375 (72.9)	17,750 (78.9)	28,250 (125.7)	41,875 (186.0)
Reduction factor, steel strength in tension	$\phi$	-	0.75							
Steel strength in shear of threaded rod	ASTM A36	$V_{sa,rod,A36}$	lb (kN)	1,105 (4.9)	2,695 (12.0)	3,130 (13.9)	4,560 (20.3)	4,940 (22.0)	7,860 (35.0)	11,640 (51.8)
Steel strength in shear of threaded rod, seismic			lb (kN)	780 (3.5)	1,900 (8.4)	2,190 (9.7)	3,190 (14.2)	3,460 (15.4)	5,505 (24.5)	8,160 (36.3)
Steel strength in shear of threaded rod	ASTM A193, Grade B7	$V_{sa,rod,B7}$	lb (kN)	2,385 (10.6)	5,815 (25.9)	6,750 (30.0)	9,825 (43.7)	10,640 (47.3)	16,950 (75.4)	25,085 (111.6)
Steel strength in shear of threaded rod, seismic			lb (kN)	1,680 (7.5)	4,095 (18.2)	4,725 (21.0)	6,880 (30.6)	7,455 (33.2)	11,865 (52.8)	17,590 (78.2)
Reduction factor, steel strength in shear	$\phi$	-	0.65							

For SI: 1 inch = 25.4 mm, 1 pound = 0.00445 kN, 1 in<sup>2</sup> = 645.2 mm<sup>2</sup>. For pound-inch unit: 1 mm = 0.03937 inches.

<sup>1</sup>Values provided for steel element material types, or equivalent, based on minimum specified strengths;  $N_{sa,rod}$  and  $V_{sa,rod}$  Calculated in accordance with ACI 318-19 Eq. 17.7.1.2a and 17.7.1.2b, respectively.  $V_{sa,rod,eq}$  must be taken as  $0.7V_{sa,rod}$ .

<sup>2</sup> $\phi N_{sa}$  shall be the lower of the  $\phi N_{sa,rod}$  or  $\phi N_{sa,insert}$  for static steel strength in tension; for seismic loading  $\phi N_{sa,eq}$  shall be the lower of the  $\phi N_{sa,rod,eq}$  or  $\phi N_{sa,insert,eq}$ .

<sup>3</sup> $\phi V_{sa}$  shall be the lower of the  $\phi V_{sa,rod}$  or  $\phi V_{sa,insert}$  for static steel strength in tension; for seismic loading  $\phi V_{sa,eq}$  shall be the lower of the  $\phi V_{sa,rod,eq}$  or  $\phi V_{sa,insert,eq}$ .

<sup>4</sup>The strength reduction factor applies when the load combinations from the IBC or ACI 318-19 are used and the requirements of ACI 318-19 Section 17.5.3 are met. Strength reduction values correspond to ductile steel elements; see Section 3.2.2 of this report for details.

TABLE 8A—EXAMPLE ASD ALLOWABLE DESIGN VALUES IN CONCRETE FOR ILLUSTRATIVE PURPOSES (lbs)<sup>1,2,3,4,5,6,7,10,11,12</sup>

Load Type	WOOD-KNOCKER II+ AND PAN-KNOCKER II+ SINGLE THREAD INSERTS									WOOD-KNOCKER II+ AND PAN-KNOCKER II+ PUSH-IN THREAD INSERTS	
	1/4-inch LP	3/8-inch LP	1/4-inch	3/8-inch	M10	M12	1/2-inch	5/8-inch	3/4-inch	3/8-inch	1/2-inch
Tension	1,085	1,085	1,555	1,800	1,800	1,800	1,800	1,800	1,800	1,725	2,200
Shear	400	1,085	720	1,710	1,710	1,800	1,800	1,800	1,800	1,470	2,200

For SI: 1 pound = 4.45 N. For pound-inch unit: 1 inch = 25.4 mm.

TABLE 8B—EXAMPLE ASD ALLOWABLE DESIGN VALUES IN CONCRETE FOR ILLUSTRATIVE PURPOSES (lbs)<sup>1,2,3,4,5,6,8,9,10,11,12</sup>

Load Type	WOOD-KNOCKER II+ AND PAN-KNOCKER II+ MULTI THREAD INSERTS															
	1/4 & 3/8 Multi (LP)		1/4 & 3/8 Multi		1/4 & 3/8 & 1/2 Multi			3/8 & 1/2 Multi		M10 & M12 Multi		3/8 & 1/2 & 5/8 Multi			5/8 & 3/4 Multi	
	1/4-inch	3/8-inch	1/4-inch	3/8-inch	1/4-inch	3/8-inch	1/2-inch	3/8-inch	1/2-inch	M10	M12	3/8-inch	1/2-inch	5/8-inch	5/8-inch	3/4-inch
Tension	1,085	1,085	1,355	1,800	1,555	1,800	1,800	1,800	1,800	1,800	1,800	2,625	2,625	2,625	2,625	2,625
Shear	400	1,085	370	1,710	720	1,710	1,800	1,410	1,800	1,410	1,800	1,510	2,625	2,625	2,625	2,625

For SI: 1 pound = 4.45 N. For pound-inch unit: 1 inch = 25.4 mm.

Illustrative Allowable Stress Design Values in Table 8A and 8B are applicable only when the following design assumptions are followed:

- <sup>1</sup>Concrete compressive strength,  $f'_c = 3,000$  psi given for normal weight concrete.
- <sup>2</sup>Single anchors with static loads and with installation in accordance with Figure 3.
- <sup>3</sup>Concrete determined to remain uncracked for the life of the anchorage.
- <sup>4</sup>Load combinations from ACI 318-19 Section 5.3 (no seismic loading).
- <sup>5</sup>30% dead load and 70% live load, controlling load combination 1.2D + 1.6L.
- <sup>6</sup>Calculation of the weighted average for  $\alpha = 1.2 \cdot 0.3 + 1.6 \cdot 0.7 = 1.48$ .
- <sup>7</sup>Assuming no edge distance influence ( $c_{e1} \geq 1.5h_{ef}$ ) and no side-face blowout in tension.
- <sup>8</sup>Assuming no edge distance ( $c_{e1} \geq 3h_{ef}$ ) or corner distance influence ( $c_{e2} \geq 1.5c_{e1}$ ) in shear.
- <sup>9</sup>Shear loads may be applied in any direction.
- <sup>10</sup> $h \geq h_{min}$  according to ACI 318-19 Section 17.9.
- <sup>11</sup>Values are for Condition B where supplementary reinforcement in accordance with ACI 318-19 Section 17.5.3 is not provided.
- <sup>12</sup>The allowable loads shown in the table are for the inserts only. The design professional is responsible for checking threaded rod strength in tension, shear and combined tension and shear, as applicable.



FIGURE 6—WOOD-KNOCKER II+ AND PAN KNOCKER II+ CONCRETE INSERTS FOR FORMS

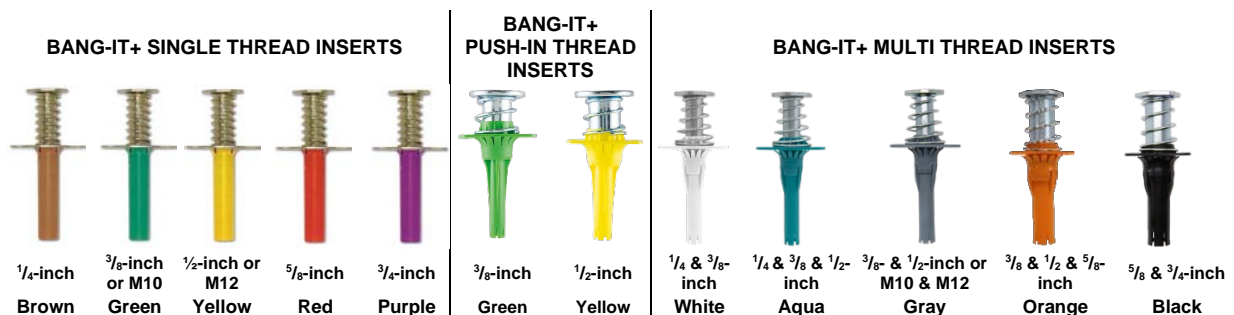

FIGURE 7—BANG-IT+ INSERTS FOR CONCRETE-FILLED STEEL DECKS



**TABLE 9A—EXAMPLE ASD ALLOWABLE DESIGN VALUES IN CONCRETE-FILLED STEEL DECK FOR ILLUSTRATIVE PURPOSES (lbs)<sup>1,2,3,4,5,6,7,8,9,10,11,12</sup>**

Deck Profile	Load Type	BANG-IT+ SINGLE THREAD INSERTS												BANG-IT+ PUSH-IN THREAD INSERTS					
		1/4-inch		3/8-inch		M10		M12		1/2-inch		5/8-inch		3/4-inch		3/8-inch		1/2-inch	
		Upper	Lower	Upper	Lower	Upper	Lower	Upper	Lower	Upper	Lower	Upper	Lower	Upper	Lower	Upper	Lower	Upper	Lower
Figure 4A	Tension	1,530	1,090	1,530	1,090	1,530	1,090	1,530	1,090	1,530	1,090	1,530	1,090	1,530	1,090	1,215	910	1,465	1,055
	Shear	805	805	925	925	925	925	925	925	925	925	1,245	1,245	1,245	1,245	1,340	930	2,795	1,235
Figure 4B	Tension	1,530	435	1,530	435	1,530	435	1,530	435	1,530	435	1,530	435	1,530	435	1,215	405	1,465	430
	Shear	730	730	845	845	845	845	845	845	845	845	1,205	1,205	1,205	1,205	1,340	930	2,795	1,030
Figure 4C	Tension	1,530	985	1,530	985	1,530	985	1,530	985	1,530	985	1,530	985	1,530	985	1,215	810	1,465	945
	Shear	730	730	845	845	845	845	845	845	845	845	1,205	1,205	1,205	1,205	1,340	930	2,795	1,030

For SI: 1 pound = 4.45 N. For pound-inch unit: 1 inch = 25.4 mm.

**TABLE 9B—EXAMPLE ASD ALLOWABLE DESIGN VALUES IN CONCRETE-FILLED STEEL DECK FOR ILLUSTRATIVE PURPOSES (lbs)<sup>1,2,3,4,5,6,7,8,10,11,12</sup>**

Deck Profile	Load Type	BANG-IT+ MULTI THREAD INSERTS																	
		1/4 & 3/8 Multi				1/4 & 3/8 & 1/2 Multi						3/8 & 1/2 Multi				M10 & M12 Multi			
		1/4-inch		3/8-inch		1/4-inch		3/8-inch		1/2-inch		3/8-inch		1/2-inch		M10		M12	
		Upper	Lower	Upper	Lower	Upper	Lower	Upper	Lower	Upper	Lower	Upper	Lower	Upper	Lower	Upper	Lower	Upper	Lower
Figure 4A	Tension	865	865	1,530	1,090	1,530	1,090	1,530	1,090	1,530	1,090	1,530	1,090	1,530	1,090	1,530	1,090	1,530	1,090
	Shear	675	470	925	925	675	515	1,435	840	1,690	840	965	845	1,690	925	965	845	1,690	925
Figure 4B	Tension	865	435	1,530	435	1,530	435	1,530	435	1,530	435	1,530	435	1,530	435	1,530	435	1,530	435
	Shear	675	470	925	845	675	515	1,435	580	1,690	725	965	845	1,690	845	965	845	1,690	845
Figure 4C	Tension	865	1,090	1,530	1,090	1,530	1,090	1,530	1,090	1,530	1,090	1,530	1,090	1,530	1,090	1,530	1,090	1,530	1,090
	Shear	675	470	925	845	675	515	1,435	580	1,690	725	965	845	1,690	845	965	845	1,690	845
Deck Profile	Load Type	3/8 & 1/2 & 5/8 Multi						5/8 & 3/4 Multi											
		3/8-inch		1/2-inch		5/8-inch		5/8-inch		3/4-inch									
		Upper	Lower	Upper	Lower	Upper	Lower	Upper	Lower	Upper	Lower								
Figure 4A	Tension	2,230	1,485	2,230	1,485	2,230	1,485	2,230	1,485	2,230	1,485	2,230	1,485	2,230	1,485	2,230	1,485	2,230	1,485
	Shear	1,975	1,020	3,280	1,020	3,280	1,020	2,280	1,235	2,625	1,235								
Figure 4B	Tension	2,230	495	2,230	495	2,230	495	2,230	495	2,230	495								
	Shear	1,975	880	3,280	880	3,280	880	2,280	770	2,625	770								
Figure 4C	Tension	2,230	1,485	2,230	1,485	2,230	1,485	2,230	1,485	2,230	1,485								
	Shear	1,975	880	3,280	880	3,280	880	2,280	770	2,625	770								

For SI: 1 pound = 4.45 N. For pound-inch unit: 1 inch = 25.4 mm.

**Illustrative Allowable Stress Design Values in Tables 9A and 9B are applicable only when all of the following design assumptions are followed:**

- <sup>1</sup>Concrete compressive strength,  $f_c = 3,000$  psi given for sand-light weight concrete. For normalweight concrete, tabulated tension design values may be increased by 17 percent for the given conditions, except for 1/4-inch-diameters where no increase is permitted.
- <sup>2</sup>Single anchors with static loads; installation in upper and lower flute locations in concrete-filled steel deck in accordance with [Figures 4A, 4B](#) or [4C](#), as applicable.
- <sup>3</sup>Concrete determined to remain uncracked for the life of the anchorage.
- <sup>4</sup>Load combinations from ACI 318-19 Section 5.3 (no seismic loading).
- <sup>5</sup>30% dead load and 70% live load, controlling load combination 1.2D + 1.6 L.
- <sup>6</sup>Calculation of the weighted average for  $\alpha = 1.2 \cdot 0.3 + 1.6 \cdot 0.7 = 1.48$ .
- <sup>7</sup> $h \geq h_{min}$  according to [Figures 4A, 4B](#) or [4C](#), as applicable.
- <sup>8</sup>Values are for Condition B where supplementary reinforcement in accordance with ACI 318-19 Section 17.5.3 is not provided.
- <sup>9</sup>Assuming no edge distance influence with  $\Psi_{ed,N} = 1.0$  in tension for upper flute anchors.
- <sup>10</sup>Assuming no edge distance ( $c_{a1} \geq 3h_{ef}$ ) or corner distance influence ( $c_{a2} \geq 1.5c_{a1}$ ) for upper flute anchors in shear. Shear loads may be applied in any direction.
- <sup>11</sup>For lower flute anchors in accordance with [Figures 4A](#), the near edge distance,  $c_{a,min}$ , is 1.125-inch. For lower flute anchors in accordance with [Figure 4B](#), the near edge distance,  $c_{a,min}$ , is 0.75-inch. For lower flute anchors in accordance with [Figure 4C](#), the near edge distance,  $c_{a,min}$ , is 0.75-inch.
- <sup>12</sup>The allowable loads shown in the table are for the inserts only. The design professional is responsible for checking threaded rod strength in tension, shear and combined tension and shear, as applicable.











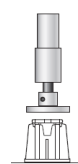

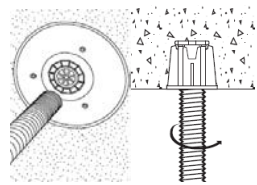



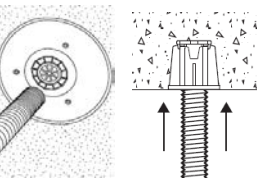

WOOD-KNOCKER II+ SINGLE OR MULTI THREAD	 <p>1.) Position insert on formwork, plastic down.</p> <p style="text-align: center;"><b>POSITION</b></p>	 <p>2.) Drive insert head down until head contacts plastic (e.g. Wood-Knocker installation tool, hammer).</p> <p style="text-align: center;"><b>DRIVE</b></p>	 <p>3.) After formwork removal, remove nails as necessary (e.g. flush mounted fixtures).</p> <p style="text-align: center;"><b>PREPARE</b></p>	 <p>4.) Guide rod/bolt through plastic center (thread seal) and fully thread steel element into the insert. Attach fixture as applicable (e.g. seismic brace).</p> <p style="text-align: center;"><b>ATTACH</b></p>
WOOD-KNOCKER II+ PUSH-IN THREAD	 <p>1.) Position insert on formwork, plastic down.</p> <p style="text-align: center;"><b>POSITION</b></p>	 <p>2.) Drive insert head down until head contacts plastic (e.g. Wood-Knocker installation tool, hammer).</p> <p style="text-align: center;"><b>DRIVE</b></p>	 <p>3.) After formwork removal, remove nails as necessary (e.g. flush mounted fixtures).</p> <p style="text-align: center;"><b>PREPARE</b></p>	 <p>4.) Push rod/bolt through plastic center (thread seal) and fully seat steel element into the insert. Attach fixture as applicable (e.g. seismic brace).</p> <p style="text-align: center;"><b>ATTACH</b></p>
PAN-KNOCKER II+ SINGLE OR MULTI THREAD	 <p>1.) Position insert on formwork, plastic down.</p> <p style="text-align: center;"><b>POSITION</b></p>	 <p>2.) Mount / secure insert to formwork (e.g. using screws, pins).</p> <p style="text-align: center;"><b>MOUNT</b></p>	 <p>3.) After formwork removal, remove screws or pins as necessary (e.g. flush mounted fixtures).</p> <p style="text-align: center;"><b>PREPARE</b></p>	 <p>4.) Guide rod/bolt through plastic center (thread seal) and fully thread steel element into the insert. Attach fixture as applicable (e.g. seismic brace).</p> <p style="text-align: center;"><b>ATTACH</b></p>
PAN-KNOCKER II+ PUSH-IN THREAD	 <p>1.) Position insert on formwork, plastic down.</p> <p style="text-align: center;"><b>POSITION</b></p>	 <p>2.) Mount / secure insert to formwork (e.g. using screws, pins).</p> <p style="text-align: center;"><b>MOUNT</b></p>	 <p>3.) After formwork removal, remove screws or pins as necessary (e.g. flush mounted fixtures).</p> <p style="text-align: center;"><b>PREPARE</b></p>	 <p>4.) Push rod/bolt through plastic center (thread seal) and fully seat steel element into the insert. Attach fixture as applicable (e.g. seismic brace).</p> <p style="text-align: center;"><b>ATTACH</b></p>
BANG-IT+ SINGLE OR MULTI THREAD	 <p>1.) Cut (e.g. drill/punch) a hole in the steel deck to the hole size required by the insert.</p> <p style="text-align: center;"><b>CREATE HOLE</b></p>	 <p>2.) Place the plastic sleeve of the insert through hole in steel deck.</p> <p style="text-align: center;"><b>POSITION</b></p>	 <p>3.) Step on or impact the insert head to engage. Optionally, base plate of insert can also be attached to steel deck (e.g. using screws).</p> <p style="text-align: center;"><b>MOUNT</b></p>	 <p>4.) Guide rod/bolt through end of plastic sleeve and fully thread steel element into the insert. Trim away / remove plastic sleeve as necessary for shear loading; Attach fixture as applicable (e.g. seismic brace).</p> <p style="text-align: center;"><b>ATTACH</b></p>
BANG-IT+ PUSH-IN THREAD	 <p>1.) Cut (e.g. drill/punch) a hole in the steel deck to the hole size required by the insert.</p> <p style="text-align: center;"><b>CREATE HOLE</b></p>	 <p>2.) Place the plastic sleeve of the insert through hole in steel deck.</p> <p style="text-align: center;"><b>POSITION</b></p>	 <p>3.) Step on or impact the insert head to engage. Optionally, base plate of insert can also be attached to steel deck (e.g. using screws).</p> <p style="text-align: center;"><b>MOUNT</b></p>	 <p>4.) Push rod/bolt through end of plastic sleeve and fully seat steel element into the insert. Trim away / remove plastic sleeve as necessary for shear loading. Attach fixture as applicable (e.g. seismic brace).</p> <p style="text-align: center;"><b>ATTACH</b></p>

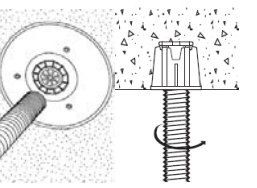
FIGURE 8—WOOD KNOCKER II+ AND PAN-KNOCKER II+ CONCRETE INSERTS FOR FORMS AND BANG-IT+ CONCRETE INSERTS FOR STEEL DECK, MANUFACTURER PRINTED INSTALLATION INSTRUCTIONS (MPII)

**TABLE 10— APPLICABLE SECTIONS OF THE IBC CODE UNDER EACH EDITION OF THE IBC**

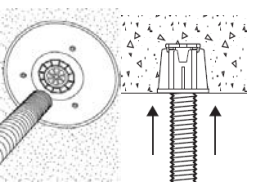
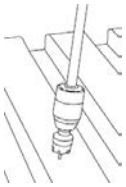
2024 IBC	2021 IBC	2018 IBC	2015 IBC
Section 1605.1		Section 1605.2 or 1605.3	
Section 1705.1.1 and Table 1705.3			
Section 1901.3			
Sections 1903 and 1905			
Section 1905.7	Section 1905.1.8		

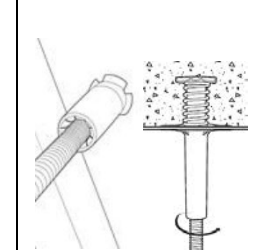
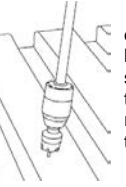
**TABLE 11— APPLICABLE SECTIONS OF ACI 318 UNDER EACH EDITION OF THE IBC**

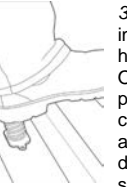
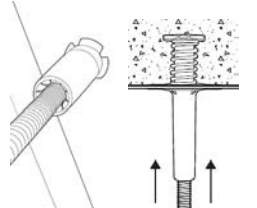
2024 IBC	2021 IBC	2018 IBC	2015 IBC
<b>ACI 318-19</b>		<b>ACI 318-14</b>	
2.3			2.3
5.3			5.3
Chapter 17			Chapter 17
17.2.4			17.2.6
17.3.1			17.2.7
17.5.1.2			17.3.1
17.5.1.3			17.3.1.1
17.5.3			17.3.3
17.6			17.4
17.6.1			17.4.1
17.6.2			17.4.2
17.6.2.1			17.4.2.1
17.6.2.2			17.4.2.2
17.6.2.5			17.4.2.6
17.6.2.6			17.4.2.7
17.6.3.1			17.4.3.1
17.6.3.2.2a			17.4.3.4
17.6.4.1			17.4.4.1
17.6.4.2			17.4.4.2
17.7			17.5
17.7.1			17.5.1
17.7.1.2			17.5.1.2
Eq. 17.7.1.2a			Eq. 17.5.1.2a
Eq. 17.7.1.2b			Eq. 17.5.1.2b
17.7.2			17.5.2
17.7.2.2			17.5.2.2
Eq.17.7.2.2.1a			Eq. 17.5.2.2a
17.7.3			17.5.3
17.8			17.6
17.9			17.7
17.9.2			17.7.2
17.10			17.2.3

**DIVISION: 03 00 00—CONCRETE**  
**Section: 03 15 19—Cast-in Concrete Anchors**  
**Section: 03 16 00—Concrete Anchors**

**REPORT HOLDER:**

DEWALT

**EVALUATION SUBJECT:**

**WOOD-KNOCKER® II+ AND PAN-KNOCKER™ II+ CONCRETE INSERTS FOR FORMS AND BANG-IT®+ CONCRETE INSERTS FOR STEEL DECK IN CRACKED AND UNCRACKED CONCRETE (DEWALT)**

**1.0 REPORT PURPOSE AND SCOPE****Purpose:**

The purpose of this evaluation report supplement is to indicate that the DEWALT Wood-Knocker II+ and Pan-Knocker II+ concrete inserts for forms and Bang-It+ concrete inserts for steel deck in cracked and uncracked concrete, described in ICC-ES evaluation report [ESR-3657](#), have also been evaluated for compliance with the codes noted below as adopted by the Los Angeles Department of Building and Safety (LADBS).

**Applicable code editions:**

- 2023 *City of Los Angeles Building Code* ([LABC](#))
- 2023 *City of Los Angeles Residential Code* ([LARC](#))

**2.0 CONCLUSIONS**

The DEWALT Wood-Knocker II+, Pan-Knocker II+, and Bang-It+ inserts in cracked and uncracked concrete, described in Sections 2.0 through 7.0 of the evaluation report [ESR-3657](#), comply with LABC Chapter 19, and the LARC, and are subject to the conditions of use described in this supplement.

**3.0 CONDITIONS OF USE**

The DEWALT Wood-Knocker II+, Pan-Knocker II+, and Bang-It+ inserts described in this evaluation report supplement must comply with all of the following conditions:

- All applicable sections in the evaluation report [ESR-3657](#).
- The design, installation, conditions of use and labeling of the DEWALT Wood-Knocker II+, Pan-Knocker II+, and Bang-It+ inserts are in accordance with the 2021 *International Building Code*® (IBC) provisions noted in the evaluation report [ESR-3657](#).
- The design, installation and inspection are in accordance with additional requirements of LABC Chapters 16 and 17, as applicable.
- Under the LARC, an engineered design in accordance with LARC Section R301.1.3 must be submitted.
- The allowable and strength design values listed in the evaluation report and tables are for the connection of the headed cast-in specialty inserts to the concrete. The connection between the headed cast-in specialty inserts and the connected members shall be checked for capacity (which may govern).
- For use in wall anchorage assemblies to flexible diaphragm applications, anchors shall be designed per the requirements of City of Los Angeles Information Bulletin P/BC 2023-071.

This supplement expires concurrently with the evaluation report, reissued December 2024 and revised April 2025.

**DIVISION: 03 00 00—CONCRETE**

**Section: 03 15 19—Cast-in Concrete Anchors**

**Section: 03 16 00—Concrete Anchors**

**REPORT HOLDER:**

**DEWALT**

**EVALUATION SUBJECT:**

**WOOD-KNOCKER® II+ AND PAN-KNOCKER™ II+ CONCRETE INSERTS FOR FORMS AND BANG-IT®+ CONCRETE INSERTS FOR STEEL DECK IN CRACKED AND UNCRACKED CONCRETE (DEWALT)**

## 1.0 REPORT PURPOSE AND SCOPE

### Purpose:

The purpose of this evaluation report supplement is to indicate that the DEWALT Wood-Knocker II+ and Pan-Knocker II+ concrete inserts for forms and Bang-It+ concrete inserts for steel deck in cracked and uncracked concrete, described in ICC-ES evaluation report ESR-3657, have also been evaluated for compliance with the codes noted below.

### Applicable code editions:

- 2023 *Florida Building Code—Building*
- 2023 *Florida Building Code—Residential*

## 2.0 CONCLUSIONS

The DEWALT Wood-Knocker II+, Pan-Knocker II+, and Bang-It+ inserts in cracked and uncracked Concrete, described in Sections 2.0 through 7.0 of the evaluation report ESR-3657, comply with the *Florida Building Code—Building* and the *Florida Building Code—Residential*. The design requirements must be determined in accordance with the *Florida Building Code—Building* or the *Florida Building Code—Residential*, as applicable. The installation requirements noted in ICC-ES evaluation report ESR-3657 for the 2021 *International Building Code*® meet the requirements of the *Florida Building Code—Building* or the *Florida Building Code—Residential*, as applicable.

Use of the Wood-Knocker II+, Pan-Knocker II+, and Bang-It+ inserts in cracked and uncracked Concrete has also been found to be in compliance with the High-Velocity Hurricane Zone Provisions of the *Florida Building Code—Building* and *Florida Building Code—Residential* with the following condition:

- a) For connections subject to uplift, the connection must be designed for no less than 700 pounds (3114 N).

For products falling under Florida Rule 61G20, verification that the report holder's quality-assurance program is audited by a quality-assurance entity approved by the Florida Building Commission for the type of inspections being conducted is the responsibility of an approved validation entity (or the code official, when the report holder does not possess an approval by the Commission).

This supplement expires concurrently with the evaluation report, reissued December 2024 and revised April 2025.