

ICC-ES Evaluation Report

ESR-2564

Reissued November 2024

This report also contains:

- [City of LA Supplement](#)
- [CA Supplement](#)
- [FL Supplement](#)

Subject to renewal October 2025

ICC-ES Evaluation Reports are not to be construed as representing aesthetics or any other attributes not specifically addressed, nor are they to be construed as an endorsement of the subject of the report or a recommendation for its use. There is no warranty by ICC Evaluation Service, LLC, express or implied, as to any finding or other matter in this report, or as to any product covered by the report.

Copyright © 2024 ICC Evaluation Service, LLC. All rights reserved.

<p>DIVISION: 09 00 00— FINISHES</p> <p>Section: 09 24 00— Portland Cement Plastering</p>	<p>REPORT HOLDER: PAREX USA, INC.</p>	<p>EVALUATION SUBJECT: PAREX USA FIBER REINFORCED STUCCO: LA HABRA-FASTWALL, LA HABRA-FASTWALL ONE, TEIFS ONE COAT, PAREX ARMOURWALL, EL REY FASTWALL AND MERLEX INSULEX</p>	
--	--	---	---

1.0 EVALUATION SCOPE

Compliance with the following codes:

- 2021, 2018, 2015, 2012, 2009 and 2006 [International Building Code® \(IBC\)](#)
- 2021, 2018, 2015, 2012, 2009 and 2006 [International Residential Code® \(IRC\)](#)

Properties evaluated:

- Structural
- Durability
- Fire-resistance-rated construction
- Types I through IV (noncombustible) construction.

2.0 USES

The Parex USA Fiber Reinforced Stucco are cementitious exterior wall coverings installed on exterior walls of wood or steel stud construction, and over walls of concrete, concrete masonry or insulated concrete foam (ICF) construction. The systems are alternatives to the exterior wall coverings specified in IBC Chapter 25, and IRC Section R703. The systems may be used to construct one-hour fire-resistance-rated and noncombustible wall assemblies when installed in accordance with Sections 4.4 and 4.5, respectively, of this report.

3.0 DESCRIPTION

3.1 General:

The Parex USA Fiber Reinforced Stucco are proprietary mixtures of portland cement, sand (if applicable), fibers, water and proprietary additives reinforced with wire fabric or metal lath, and are applied to substrates of expanded polystyrene (EPS), extruded polystyrene (XPS) and polyisocyanurate foam plastic insulation boards, concrete or concrete masonry (with or without lath), wood structural panels, fiberboard and gypsum sheathing.

3.2 Materials:

3.2.1 One Coat Stucco—Concentrated: The stucco mixes for the Parex USA Fiber Reinforced Stucco Concentrated Assemblies (La Habra-Fastwall 100, Teifs One Coat, Parex Armourwall 100, El Rey Fastwall

100 and Merlex Insulex) are identified as La Habra-Fastwall Stucco Concentrate; Teifs One Coat Concentrate; Parex 210 ArmourWall Stucco Base Concentrate; El Rey FastWall Concentrate; and Merlex Insulex Concentrate, respectively. The mixes are factory-prepared mixtures of Type I or Type II portland cement complying with ASTM C150, chopped fibers, and proprietary additives. The stucco mixtures are packaged in 80-pound (36 kg) bags. Four and one-half to 6 gallons (17 to 22.7 L) of water and 200 to 240 pounds (90.7 to 108.9 kg) of sand complying with Section 3.2.2 of this report are added to each 80-pound (36.3 kg) bag in the field, and mixed in accordance with the manufacturer's recommendations.

3.2.2 One Coat Stucco—Sanded: The stucco mixes for the Parex USA One Coat Stucco Sanded Systems (La Habra-Fastwall 100, La Habra-Fastwall One, Teifs One Coat, Parex Armourwall 100, and El Rey Fastwall 100) are identified as La Habra Fastwall Stucco Sanded; La Habra-Fastwall One Finish and Base Coat in One; Teifs One Coat Sanded; Parex 202 ArmourWall Stucco Base Sanded; and El Rey FastWall Sanded, respectively. The mixes are provided in premixed 80-pound (36.3 kg) bags, which are mixed in the field with 1.3 to 1.5 gallons (4.92 to 5.67) of water per bag.

3.2.3 Sand: Sand must be clean and free from deleterious amounts of loam, clay, silt, soluble salts and organic matter. Sampling and testing must comply with ASTM C144 or ASTM C897. Sand must be natural sand graded in accordance with ASTM C144 or C897 within the following limits:

RETAINED ON U.S. STANDARD SIEVE	PERCENT RETAINED BY WEIGHT ± 2 PERCENT	
	Min.	Max.
No. 4 (4.75 mm)	0	0
No. 8 (2.36 mm)	0	10
No. 16 (1.18 mm)	10	40
No. 30 (600 μm)	30	65
No. 50 (300 μm)	70	90
No. 100 (150 μm)	95	100
No. 200 (75 μm)	97	100

3.2.4 Insulation Board:

3.2.4.1. Expanded Polystyrene: EPS board must have a nominal density of 1.5 pounds per cubic foot (24 kg/m³); a Class A flame-spread index of 25 or less and a smoke-developed index of 450 or less; and must comply with ASTM C578 as Type II board. Boards installed without sheathing over open framing must be 1 inch to 1½ inches (25.4 to 38.1 mm) thick and must be provided with ¾-inch-high (19.0 mm) tongues with compatible grooves for horizontal joints. See [Figure 1](#) for joint details. All boards must be recognized in a current ICC-ES evaluation report or be suitably listed and produced by a molder that participates in an approved third-party quality control assurance program. See Section 7.2 for board identification. Over solid substrates, a square-edge foam plastic board with a minimum ½-inch (12.7 mm) thickness and a minimum nominal density of 1 pcf (16 kg/m³) is permitted except when installation is as part of the water-resistive barrier over wood-based sheathing as described in Section 3.2.10.1, which requires 1-inch-thick (25.4 mm) EPS boards with tongue-and-groove edges.

3.2.4.1.1.

When installation is over solid sheathing, as described in Section 4.3, the boards must have minimum ¼-inch-wide-by-⅛-inch-deep (6.4 mm by 3.2 mm) vertical grooves spaced a maximum of 12 inches (305 mm) on the back face of the board. As an alternate to the vertical grooves on the foam plastic board, installation of flat-faced board over a solid sheathing may incorporate the Tyvek StuccoWrap water-resistive barrier recognized in [ESR-2375](#), or a three-dimensional drainage mat recognized in [ESR-1935](#).

3.2.4.2. Extruded Polystyrene: The board must have a minimum density of 1.5 pcf (24 kg/m³) and must comply with ASTM C578 as a Type IV or V board. See Section 3.2.4.1 for other details and requirements.

3.2.4.3. Polyisocyanurate Foam Board: Polyisocyanurate foam plastic board must comply with ASTM C1289 as Type II board. Polyisocyanurate foam plastic board must have a nominal density of 2 pcf (32 kg/m³) and a maximum flame-spread index of 25 or less and a smoke-developed index of 450 or less. The foam plastic board must be 1 inch to 1½ inches (25 to 38 mm) thick, have all squared joints installed at horizontal and vertical edges supported by framing or blocking, and be limited to nonfire-resistive-rated and combustible construction. All boards must be recognized in a current ICC-ES evaluation report or be suitably listed and produced by a molder that participates in an approved third-party quality control assurance program. See Section 7.2 for board identification. Over solid substrates, a square-edge foam plastic board is permitted, with the same requirements set forth in Section 3.2.4.1.

3.2.4.4. Use over Solid Sheathing: When foam plastic insulation boards are used over solid sheathing with

a code-complying water-resistive barrier, the following foam plastic boards may be used:

- a. Parex Water Master Expanded Polystyrene as recognized in [ESR-2562](#).
- b. One-inch TeifsChannelBoard as recognized in [ESR-1935](#).
- c. TeifsDrainBoard as recognized in [ESR-1935](#).
- d. One-inch-thick (25.44 mm) EPS foam, complying with ASTM C578, Type I, insulation board with $\frac{1}{4}$ -inch-by- $\frac{1}{4}$ -inch (6 mm by 6 mm) vertical grooves spaced at 3 inches (76 mm) on center .
- e. One-inch (25.44 mm)-thick, flat-faced, foam plastic insulation board with either Tyvek Stucco Wrap, recognized in [ESR-2375](#), as the water-resistive barrier or having a three-dimensional drainage mat, recognized in [ESR-1935](#), placed between the foam and the water-resistive barrier.
- f. Foam plastic board having minimum $\frac{1}{2}$ -inch-wide-by- $\frac{1}{4}$ -inch-deep (12.7 mm by 6.4 mm) vertical grooves spaced a maximum of 12 inches (305 mm) on the back face of the boards, as recognized in [ESR-1788](#).

3.2.5 Lath:

3.2.5.1. Wire Fabric Lath: Wire fabric lath must comply with the ICC-ES Acceptance Criteria for Metal Plaster Bases (Lath) (AC191). Minimum No. 20 gage [0.035 inch (0.89 mm)], 1-inch-opening (25.4 mm), galvanized steel, woven-wire fabric must be used. Lath must be furred when applied over all substrates. Furring must comply with the following requirements:

- When maximum total coating thickness is $\frac{1}{2}$ inch (12.7 mm) or less, the body of the lath must be furred a minimum of $\frac{1}{8}$ inch (3.2 mm) from the substrate after installation.
- When the total coating thickness is greater than $\frac{1}{2}$ inch (12.7 mm), minimum No. 17 gage [0.058 inch (1.47 mm)] by $1\frac{1}{2}$ -inch (38 mm), woven-wire fabric lath must be used. The body of the lath must be furred a minimum of $\frac{1}{4}$ inch (6.4 mm) from the substrate after installation.

3.2.5.2. Metal Lath: Metal lath must comply with AC191 and, as applicable, IBC Table 2507.2 or IRC Section R703.6. Furring requirements are as set forth in Section 3.2.5.1.

3.2.6 Gypsum Board: Water-resistant treated core gypsum sheathing must comply with ASTM C79, ASTM C1177 or ASTM C1396. Gypsum wallboard must comply with ASTM C36 or ASTM C1396.

3.2.7 Fiberboard: Minimum $\frac{1}{2}$ -inch-thick asphalt-impregnated fiberboard must comply as ASTM C208, Type IV, wall sheathing.

3.2.8 Wood Structural Panels: The panels must be minimum $\frac{3}{8}$ -inch-thick (9.5 mm) plywood or OSB for studs spaced 16 inches (406 mm) on center, and must be minimum $\frac{7}{16}$ -inch-thick (11.1 mm) plywood or OSB for studs spaced 24 inches (610 mm) on center. Plywood must be exterior-grade or Exposure 1 plywood complying with U.S. Department of Commerce Product Standard PS-1 or UBC Standard 23-2, as applicable; and OSB must be Exposure 1 complying with U.S. Department of Commerce Product Standard PS-2 or UBC Standard 23-3, as applicable.

3.2.9 Caulking: Caulking materials must be either acrylic latex complying with ASTM C834, or polyurethane, polyurethane modified, polysulfide, or silyl-terminated polyether elastomeric sealants complying with ASTM C920.

3.2.10 Weather Protection:

3.2.10.1. Water-resistive Barrier: A water-resistive barrier is required and must comply with 2021 and 2018 IBC Section 1403.2 [2015, 2012 and 2009 and 2006 IBC Section 1404.2], or IRC Section R703.2, as applicable. Minimum No. 15, asphalt nonperforated felt complying as Type I in accordance with ASTM D226 (IBC or IRC); or material recognized in a current ICC-ES evaluation report as complying with the ICC-ES Acceptance Criteria for Water-resistive Barriers (AC38); or a water-resistive coating described in [ESR-2045](#), is required, as applicable.

When applied over any wood-based sheathing, the barrier must be either: (a) for dry climate zones, a minimum of two layers of 10-minute Grade D paper or have a water-resistance equal to or greater than two layers of water-resistive barrier complying with ASTM E2556, Type I under 2021 IBC Section 2510.6.1; for moist or marine climates under IBC Section 2510.6.2, in addition to complying with dry climate zones (2021 IBC Section 2510.6.1) water-resistive barrier requirements, a drainage medium complying with Section 3.2.4.1.1 must be installed; a minimum of two layers of Grade D kraft building paper as set forth in 2012, 2009

and 2006 IBC Section 2510.6, or 2018 and 2015 IRC Section R703.7.3 [2012, 2009 and 2006 IRC Section R703.6.3]; a minimum of two layers of water-resistive barrier complying with ASTM E2556 Type I as set forth in 2018 and 2015 IBC Section 2510.6; or (b) under the 2012, 2009 and 2006 IBC or the IRC, one layer of EPS or XPS insulation board having horizontal tongue-and-groove edges as described in Section 3.2.4.1, over one layer of Grade D kraft building paper having a minimum water-resistance rating of 60 minutes, or an equivalent water-resistive barrier recognized in a current ICC-ES evaluation report; under the 2018 and 2015 IBC one layer of EPS or XPS insulation board having horizontal tongue-and-groove edges as described in Section 3.2.4.1, over one layer of water-resistive barrier complying with ASTM E2556, Type II.

When Parex USA WeatherSeal is used as the water-resistive barrier, installation must be in accordance with [ESR-2045](#).

When Tyvek StuccoWrap, recognized in [ESR-2375](#), is used as the water-resistive barrier, vertically grooved insulation boards, as described in Section 3.2.4.4, are not required. The Tyvek StuccoWrap must be installed as described in [ESR-2375](#).

3.2.10.2. Vapor Retarder: Protection against condensation must be provided in accordance with 2021 and 2018 IBC Section 1404.3 [2015, 2012 and 2009 IBC Section 1405.3 or 2006 IBC Section 1403.2], as applicable. Under the 2021, 2018, 2015 and 2012 IRC vapor retarder must be provided in accordance with IRC Section R702.7, unless its omission is permitted under the exceptions in IRC Section R702.7. Under the 2009 IRC, a vapor retarder must be provided in accordance with Section R601.3, unless its omission is permitted under the exceptions in Section R601.3. Under the 2006 IRC, a vapor retarder must be provided in accordance with Section R318.1, unless its omission is permitted under the exceptions in 2006 IRC Section R318.1.

3.2.10.3. Flashing: Flashing complying with 2021, 2018 IBC Section 1404.4 [2015, 2012 and 2009 IBC Section 1405.4, 2006 IBC Section 1405.3], 2021, 2018 and 2015 IRC Section R703.4, or 2012, 2009 and 2006 IRC Section R703.8, as applicable, must be provided. Where membrane flashing is used, flashing must be a self-adhering, flexible rubberized asphalt and polyethylene material, a minimum of 0.020-inch (0.51 mm) thick, shingle-lapped with the water-resistive barrier.

3.2.11 Trim and Accessories: All trim, weep screeds and corner reinforcement must be corrosion-resistant.

4.0 INSTALLATION

4.1 General:

The exterior cementitious coating is applied by hand-troweling or machine-spraying, in one coat or two coats, to a minimum $\frac{3}{8}$ -inch (9.5 mm) thickness, unless noted otherwise. Nominal thickness around penetrations is $\frac{3}{8}$ inch (9.5 mm), backed by framing or blocking. The lath must be embedded in the minimum coating thickness and therefore cannot be exposed. The finish coat must be applied in accordance with the manufacturer's instructions. Flashing, corner reinforcement, metal trim and weep screeds must be installed as shown in [Figure 2](#).

The coating must be applied at ambient air temperatures between 40°F and 120°F (4.4°C and 49°C) by applicators listed by Parex USA, Inc. The water-resistive barrier must be applied as set forth in Section 3.2.10.1. An installation card, similar to that illustrated in [Figure 3](#), must be at the jobsite with the name of the applicator and the product to be used, before any water-resistive barrier or exterior sheathing is installed. Also see Section 5.6 of this report.

4.2 Application over Open Framing: Foam Plastic Insulation Board:

The water-resistive barrier, as set forth in Section 3.2.10.1, is placed over open studs spaced a maximum of 24 inches (610 mm) on center. The EPS, XPS, or polyisocyanurate foam plastic insulation board, as described, respectively, in Sections 3.2.4.1, 3.2.4.2, and 3.2.4.3, must be attached using galvanized staples, roofing nails, or screws. Vertical butt joints must be staggered at least one stud space from adjacent courses, and must occur directly over studs.

The lath must then be applied tightly over the insulation board and fastened through the board and water-resistive barrier to wood studs using No. 11 gage galvanized roofing nails or No. 16 gage corrosion-resistant staples spaced a maximum of 6 inches (152 mm) on center, with a minimum 1-inch (25.4 mm) penetration into the studs. Staples must have a minimum crown width of $\frac{7}{16}$ inch (11.1 mm). The wood species must have a minimum specific gravity of 0.42. Care must be taken to avoid over-driving fasteners.

The Parex USA Fiber Reinforced Stucco System may also be applied over minimum No. 20 gage [minimum 0.0359-inch (0.91 mm)] steel studs spaced a maximum of 24 inches (610 mm) on center. The lath must be fastened through the insulation board and water-resistive barrier to the metal studs using minimum No. 8,

Type S, drywall screws with 1-inch-diameter (25.4 mm) washers, or No. 8 screws having $\frac{3}{8}$ -inch-diameter (9.5 mm) pan heads, at 6 inches (152 mm) on center to all studs and track. Screws must penetrate the stud a minimum of $\frac{1}{2}$ inch (12.7 mm).

Lath must be applied with $1\frac{1}{2}$ -inch (38 mm) end and side laps. Wall bracing in accordance with 2021, 2018 and 2015 IBC Section 2308.6, 2012, 2009 and 2006 IBC Section 2308.9.3, IRC Sections R602.10, or an acceptable alternate, is required. Square wall corners and parapet corners must be covered with metal corner reinforcement. For round wall, bull nose and parapet corners, metal reinforcement is optional when construction is in accordance with [Figure 2](#). Weep screed must comply with, and be installed at the bottom of the wall in accordance with, IBC Section 2512.1.2, 2021, 2018 and 2015 IRC Section R703.7.2.1, or 2012, 2009 and 2006 IRC Section R703.6.2, as applicable. Galvanized steel, J-shaped trim pieces are installed at other areas where foam is exposed. At windows and doors, flashing as described in Section 3.2.10.3 of this report is required. Butting J-trim and approved metal edges, when installed, must be flashed in accordance with the code. Holes for hose bibbs, electrical panels, and other penetrations of substrate surfaces, except those caused by fasteners, must also be flashed in accordance with the code. The coating must then be applied as described in Section 4.1.

4.3 Application over Solid Backing:

4.3.1 General: When the optional insulation board is installed over solid sheathing, the drainage system must be provided by using one of the following systems:

- a. One layer of water-resistive barrier as described in Section 3.2.10.1, over sheathing and Parex Water Master Grooved (vertically grooved) EPS Board, with installation as described in [ESR-2562](#).
- b. One layer of water-resistive barrier as described in Section 3.2.10.1, over sheathing and TeifsChannelboard (vertically grooved foam board), with minimum thickness of $1\frac{1}{4}$ inches (31.7 mm) and maximum thickness of 4 inches (102 mm), and installation as described in [ESR-1935](#).
- c. One layer of water-resistive barrier as described in Section 3.2.10.1 over sheathing and TeifsDrainboard (vertically grooved foam board), with minimum thickness of $1\frac{1}{2}$ inches (38 mm) and maximum thickness of 4 inches (102 mm), and installation as described in [ESR-1935](#).
- d. One layer of water-resistive barrier as described in Section 3.2.10.1 over sheathing; drainage mat as described in [ESR-1935](#); and EPS flat-faced foam plastic insulation board, with installation as described in [ESR-1935](#).
- e. Tyvek StuccoWrap with installation as described in [ESR-2375](#), and $1\frac{1}{2}$ -inch-thick (38 mm) TeifsDrainboard, with installation as described in [ESR-1935](#).
- f. One layer of DuPont Tyvek StuccoWrap, with installation as described in [ESR-2375](#), and 1-inch-thick (25.4 mm), flat-faced foam plastic insulation board with a nominal density of 1 pcf (17.7 kg/m³).

4.3.2 Fiberboard: Minimum $\frac{1}{2}$ -inch-thick (12.7 mm) fiberboard, as described in Section 3.2.7, is installed directly over wood or steel studs spaced a maximum of 24 inches (610 mm) on center. The fiberboard is temporarily held in place using corrosion-resistant staples, roofing nails (for wood studs) or self-tapping screws (for steel studs). A water-resistive barrier must be applied over the fiberboard, as set forth in Section 3.2.10.1 of this report, prior to installation of lath or optional foam board.

The lath must be attached to the studs through the sheathing, with fasteners and spacing as described in Section 4.2 of this report or as described for fiberboard in 2021 IBC Table 2304.10.2, 2018 and 2015 IBC Table 2304.10.1, 2012, 2009 and 2006 IBC Table 2304.9.1 or IRC Table R602.3(1), as applicable, whichever is more restrictive. All walls must be braced in accordance with the applicable code. Exposed sheathing edges must be protected with trim. Openings in the substrate surface must be flashed in accordance with the code, and the coating must be applied in accordance with Section 4.1. The fiberboard, optional foam plastic insulation board, lath and coating may be applied to minimum No. 20 gage [0.0359 inch (0.91 mm)] steel studs spaced a maximum of 24 inches (610 mm) on center, provided the fasteners and their placement are as set forth in Section 4.2 for steel studs.

4.3.3 Gypsum Sheathing: Minimum $\frac{1}{2}$ -inch-thick (12.7 mm), water-resistant treated core gypsum sheathing, described in Section 3.2.6 of this report, must be installed directly over wood studs spaced a maximum of 24 inches (610 mm) on center. Gypsum sheathing must be fastened in accordance with ASTM C1280 (IBC), or IRC Table R702.3.5, as applicable. Water-resistant treated core gypsum sheathing or water-resistant exterior fiber-reinforced gypsum sheathing, as described in Section 3.2.6 of this report, must be fastened in accordance with the applicable evaluation report. A water-resistive barrier must be applied over the gypsum sheathing in accordance with Section 3.2.10.1 before application of lath or optional insulation board. The lath must be

attached to the studs through the sheathing with fasteners and spacing as described for insulation board in Section 4.2. All walls must be braced in accordance with the applicable code. Openings in the substrate surface must be flashed in accordance with the code, and the coating must be applied as described in Sections 4.1 and 4.2.

4.3.4 Wood-based Sheathing: Wood-based sheathing must be applied directly to wood or steel studs under conditions set forth in Section 3.2.8 and 2021, 2018 and 2015 IBC Table 2308.6.3(3), 2012, 2009 and 2006 IBC Table 2308.9.3(3), or IRC Table R602.3(3), as applicable. The water-resistive barrier, optional foam plastic insulation board, wire fabric lath, and coating must be applied as described in Section 4.3.2 for fiberboard. Installation to minimum No. 20 gage [0.0396 inch (0.91 mm)] steel studs spaced a maximum of 24 inches (610 mm) on center is as described in Section 4.3.2 for fiberboard. Application of the stucco system is as set forth in Section 4.3.2 of this report.

4.3.5 Concrete and Masonry:

4.3.5.1 Direct Application without Lath: Surface preparation of cast-in-place or precast concrete and masonry shall be straight and true within $\frac{1}{4}$ inch (6.4 mm) in 10 feet (3048 mm) and shall be in accordance with Section 2510.7 of the IBC. Surfaces shall be clean and free from any deleterious materials. Surfaces shall be adequately rough to have good absorption for proper bonding. Cast-in-place or precast concrete that has smooth or nonabsorbent solid surfaces shall be prepared to receive stucco by sandblasting, wire brushing, acid etching, or chipping. The coating shall be applied directly to the prepared surface at a minimum thickness of $\frac{3}{8}$ inch (9.5 mm) in accordance with Section 4.1 of this report.

4.3.5.2 Application with Lath: Lath and furring used to receive stucco shall be installed and conform with ASTM C1063. Fasteners used to install the lath shall be recognized in an ICC-ES evaluation report. The lath shall be fastened in vertical rows, a maximum of 24 inches (609.6 mm) on center. Fastener spacing in each row shall be a maximum of 6 inches (152.4 mm). The coating shall be applied in accordance with Section 4.1 of this report.

4.4 One-hour Fire-resistive Wall Assemblies

The assemblies described in this section are rated for exposure to fire from both sides, unless otherwise noted.

4.4.1 First Assembly:

4.4.1.1 Interior Face: One layer of $\frac{5}{8}$ -inch-thick (15.9 mm), Type X gypsum wallboard, water-resistant backer board, or veneer base is applied vertically or horizontally to the interior face of minimum nominally 2-by-4 wood studs spaced a maximum of 24 inches (610 mm) on center. The wall board must be attached using $1\frac{7}{8}$ -inch-long (48 mm), $\frac{1}{4}$ -inch-diameter-head (6.4 mm), 6d coated nails at 7 inches (178 mm) on center, with attachment to studs, plates and blocking. All wallboard joints must be backed with minimum nominally 2-by-4 wood framing, and taped and treated with joint compound. Fastener heads must also be treated with joint compound in accordance with ASTM C840 or GA-216.

4.4.1.2 Exterior Face: One layer of minimum $\frac{5}{8}$ -inch-thick (15.9 mm), Type X, water-resistant core gypsum sheathing, 48 inches (1219 mm) wide, must be applied parallel to studs using $1\frac{3}{4}$ -inch-long (44.5 mm), No. 11 gage [0.148-inch (3.8 mm) shaft diameter] galvanized roofing nails having $\frac{7}{16}$ -inch- or $\frac{1}{2}$ -inch-diameter (11.1 mm or 12.7 mm) heads, spaced at 4 inches (102 mm) on center at board edges and 7 inches (178 mm) on center at intermediate studs and top and bottom plates. Nails must penetrate framing a minimum of 1 inch (25.4 mm). A water-resistive barrier must be applied over the sheathing in accordance with Section 3.2.10.1. The lath and wall coating must then be applied without insulation board as described in Section 4.1.

4.4.1.3 Axial Load Design: The wood stud axial design stress for the wall assembly calculated in accordance with Sections 3.6 and 3.7 of ANSI AWC NDS (2021, 2018, 2015 and 2012 IBC and IRC), or Sections 3.6 and 3.7 of ANSI AF&PA NDS-05 (2009 and 2006 IBC and IRC) is limited to $0.78 F'_c$, and the maximum stress must not exceed $0.78 F'_c$ at a maximum l_e/d ratio of 33.

4.4.2 Second Assembly:

4.4.2.1 Interior Face: One layer of $\frac{5}{8}$ -inch-thick (15.9 mm), Type X gypsum wallboard, complying with ASTM C1396, is applied horizontally to the interior face of minimum nominally 2-by-4 wood studs spaced a maximum of 16 inches (406 mm) on center. The wallboard is fastened with $1\frac{5}{8}$ -inch-long (41.3 mm), 5d gypsum wallboard nails having minimum 0.086-inch (2.18 mm) shank diameters and $1\frac{5}{64}$ -inch-diameter (23.8 mm) heads, spaced at 6 inches (152 mm) on center to studs, plates and blocking. All wallboard joints must be backed by minimum nominally 2-by-4 wood framing and taped and treated with joint compound complying with ASTM C840 or GA-216. Fastener heads must also be treated with joint compound in accordance with ASTM C840 or GA-216.

4.4.2.2 Exterior Face: Minimum $3^{5/8}$ -inch-thick (92 mm), paper-faced, R-13, mineral wool batt insulation, having a 1.94 pcf (31 kg/m³) density, must be installed in the wall cavity. A water-resistive barrier, described in Section 3.2.10.1, must be applied over the exterior face of framing in accordance with 2018 IBC Section 1403.2 [IBC Section 1404.2] or IRC Section 703.2, followed by 1-inch-thick (25.4 mm), 1.5 pcf density (24 kg/m³) EPS board installed in accordance with Section 4.2 of this report. The lath must then be installed horizontally and attached in accordance with Section 4.2, except that $2^{1/2}$ -inch-long (63.5 mm), No.11 gage nails having $3/8$ -inch-diameter (9.5 mm) heads must be used. The lath requires 2-inch (51 mm) overlaps. The Parex USA Fiber Reinforced Stucco must then be applied to a minimum $3/8$ -inch (9.5 mm) thickness, in accordance with Section 4.1.

4.4.2.3 Axial Design: The axial loads applied to the wall assembly are limited to the least of the following:

- 1,100 pounds (4893 N) per stud.
- A maximum of 46 percent of the load calculated in accordance with Sections 3.6 and 3.7 of ANSI AWC NDS (2021, 2018, 2015 and 2012 IBC and IRC), or Sections 3.6 and 3.7 of the ANSI/AF&PA NDS-05 (2009 and 2006 IBC and IRC).
- Design stress based on $0.78 F'_c$ calculated in accordance with Sections 3.6 and 3.7 of ANSI AWC NDS (2021, 2018, 2015 and 2012 IBC and IRC), Sections 3.6 and 3.7 of the ANSI/AF&PA NDS-05 (2009 and 2006 IBC and IRC).
- Design stress of $0.78 F'_c$ at a maximum l_e/d ratio of 33 calculated in accordance with Sections 3.6 and 3.7 of ANSI AWC NDS (2021, 2018, 2015 and 2012 IBC and IRC), or Sections 3.6 and 3.7 of the ANSI/AF&PA NDS-05 (2009 or 2006 IBC and IRC).

4.4.3 Third Assembly:

4.4.3.1 Interior Face: One layer of $5/8$ -inch-thick (15.9 mm), Type X gypsum wallboard complying with ASTM C36 or ASTM C1396 must be attached horizontally to the interior face of minimum nominally 2-by-4 wood studs spaced a maximum of 24 inches (610 mm) on center. The wallboard must be attached to studs and perimeter framing using $1^{5/8}$ -inch-long (41.3 mm), galvanized steel cupped-head nails spaced a maximum of 8 inches (203 mm) on center. All wallboard joints must be backed by minimum nominally 2-by-4 wood framing and covered with paper tape and treated with joint compound complying with ASTM C840 or GA-216. Fastener heads must also be treated with joint compound complying with ASTM C840 or GA 216.

4.4.3.2 Exterior Face: Any of the following substrates may be used independently or in combination with one another:

- One layer of minimum $1/2$ -inch-thick (12.7 mm), water-resistant core gypsum sheathing.
- One layer of minimum $7/16$ -inch-thick (11.1 mm) OSB.
- One layer of minimum $1^{5/32}$ -inch-thick (11.9 mm) plywood.

The substrates must be as described in Sections 3.2.6 through 3.2.8, and must be installed on wood framing as described in Section 4.3. The water-resistive barrier must be installed over the sheathing in accordance with Section 3.2.10.1. The lath and wall coating must be applied as described in Section 4.1. Foam plastic insulation is not permitted in this assembly.

4.4.3.3 Axial Load Design: The allowable axial loading for this system is limited to the least of the following:

- 1,100 pounds (499 kg) per stud.
- A maximum of 46 percent of the load calculated in accordance with Sections 3.6 and 3.7 of the ANSI AWC NDS (2021, 2018, 2015 and 2012 IBC and IRC), or Sections 3.6 and 3.7 of the ANSI/AF&PA NDS-05 (2009 and 2006 IBC and IRC).
- Design stress of $0.78 F'_c$ at a maximum l_e/d ratio of 33 calculated in accordance with Sections 3.6 and 3.7 for ANSI AWC NDS (2021, 2018, 2015 and 2012 IBC and IRC) Sections 3.6 and 3.7 of the ANSI/AF&PA NDS-05 (2009 and 2006 IBC and IRC).

4.4.4 Fourth Assembly:

4.4.4.1 Interior Face: One layer of $5/8$ -inch-thick (15.9 mm), Type X gypsum wallboard, complying with ASTM C1396, is applied vertically to the interior face of minimum nominally 2-by-4 wood studs spaced a

maximum of 24 inches (609 mm) on center. The wallboard is fastened with $1\frac{5}{8}$ -inch-long (41.3 mm), 5d gypsum wallboard nails having minimum 0.086-inch (2.18 mm) shank diameters and $1\frac{5}{64}$ -inch-diameter (23.4 mm) heads, spaced at 8 inches (203 mm) on center to studs, plates and blocking. All wallboard joints must be backed by minimum nominally 2-by-4 wood framing and taped and treated with joint compound complying with ASTM C840 or GA-216. Fastener heads must also be treated with joint compound in accordance with ASTM C840 or GA-216.

4.4.4.2 Exterior Face: Minimum $\frac{7}{16}$ -inch-thick (11.1 mm), APA-rated OSB sheathing must be applied using minimum #6d, $1\frac{7}{8}$ -inch-long (47.6 mm) coated sinker nails spaced maximum 8 inches (203 mm) on center around the perimeter and in the field. Water-resistive barrier must be installed over sheathing in accordance with Section 3.2.10.1. Insulation board with a maximum 1.66 pcf must be installed over the water resistive barrier with the long edge perpendicular to studs. Lath installed using minimum $\frac{3}{8}$ -inch (9.8 mm) J-metal flange casing bead. The Parex USA Fiber Reinforced Stucco must be mixed in accordance with section 3.2.1 and the manufacturer's recommendations, and must be applied to a minimum $\frac{3}{8}$ -inch (9.5mm) thickness in accordance with section 4.1 of this report.

4.4.4.3 Axial Design The axial loads applied to the wall assembly are limited to the least of the following:

- 1,050 pounds (4671 N) per stud.
- A maximum of 44 percent of the load calculated in accordance with Sections 3.6 and 3.7 of ANSI AWC NDS (2021, 2018, 2015 and 2012 IBC and IRC), or Sections 3.6 and 3.7 of ANSI/AF&PA NDS-05 (2009 and 2006 IBC and IRC).
- Design stress based on $0.78 F'_c$ calculated in accordance with Sections 3.6 and 3.7 of ANSI AWC NDS (2021, 2018, 2015 and 2012 IBC and IRC), or Sections 3.6 and 3.7 of ANSI/AF&PA NDS-05 (2009 and 2006 IBC and IRC).
- Design stress of $0.78 F'_c$ at a maximum l_e/d ratio of 33 calculated in accordance with Sections 3.6 and 3.7 of ANSI AWC NDS (2021, 2018, 2015 and 2012 IBC and IRC), or Sections 3.6 and 3.7 of ANSI/AF&PA NDS-05 (2009 and 2006 IBC and IRC).

4.5 Noncombustible Construction: (Types I, II III and IV):

The Parex USA Fiber Reinforced Stucco may be installed on exterior walls of Type I, II, III or IV construction under the IBC, as described in Sections 4.5.1 and 4.5.2. An exception is that recognition is limited to use in exterior walls of buildings having a maximum height of 40 feet (12.2 m) above grade under the 2021, 2018, 2015 and 2012 IBC as indicated in 2021 and 2018 IBC Section 1402.5 [2015 and 2012 IBC Section 1403.5].

4.5.1 With Foam Plastic under the 2018, 2015, 2012, 2009 and 2006 IBC: The stucco system with foam plastic must be installed as noted in Sections 4.5.1.1 through 4.5.1.6.

4.5.1.1 Interior Finish: One layer of $\frac{5}{8}$ -inch-thick (15.9 mm), Type X gypsum wall board complying with ASTM C79 or ASTM C1396 must be applied vertically to steel framing with all edges blocked. Fasteners must be No. 8 by $1\frac{1}{4}$ -inch-long (31.7 mm) buglehead screws at 8 inches (203 mm) on center at board joints and 12 inches (305 mm) on center at intermediate locations. All joints must be taped and treated with joint compound complying with ASTM C840 or GA-216. Intermediate fasteners must also be treated with compound complying with ASTM C840 or GA-216.

4.5.1.2 Steel Framing: Minimum $3\frac{5}{8}$ -inch-deep(92 mm), minimum No. 20 gage [0.0359-inch (0.91 mm)] steel studs spaced a maximum of 16 inches (406 mm) on center.

4.5.1.3 Openings: Wall openings must be framed with minimum 0.125-inch-thick (3.2 mm) tubular aluminum or steel framing.

4.5.1.4 Exterior Finish: One layer of minimum $\frac{1}{2}$ -inch-thick (12.7 mm) water-resistant core gypsum sheathing, complying with ASTM C79 or ASTM C1396, must be applied horizontally or vertically and attached to the steel framing using No. 8 by $1\frac{1}{4}$ -inch-long (31.7 mm), bugle head screws spaced 8 inches (203 mm) on center at all framing locations.

4.5.1.5 Stud Cavity: At floor levels, mineral wool batt insulation designed for fire blocking applications must be friction-fitted into each cavity. The insulation must have a minimum 4-pound-per-cubic-foot (64 kg/m³) density, and must be 4 inches (102 mm) thick and must be approximately 6 to 8 inches (152 to 203 mm) wide. The insulation must be long enough to achieve a friction fit within a stud cavity.

4.5.1.6 Stucco System: Where a water-resistive barrier is required, the stucco system includes one layer of water-resistive barrier described in Section 3.2.10.1, having a flame-spread index of 25 or less and a smoke-developed index of 450 or less. The water-resistive barrier must be installed over the sheathing in accordance with 2021 and 2018 IBC Section 1403.2 [2015, 2012, 2009 and 2006 IBC Section 1404.2], or IRC Section R703.2, as applicable. One-inch-thick (25.4 mm) EPS insulation board with a nominal 1.5 pcf density must be installed horizontally in running bond over the sheathing. The lath, insulation board and water-resistive barrier are positively fastened to the steel framing using No. 8 by 2¹/₂-inch-long (63.5 mm), wafer-head, self-drilling screws spaced at a maximum of 8 inches (203 mm) on center to all framing members. The Parex USA Fiber Reinforced Stucco must be mixed in accordance with Section 3.2.1 and the manufacturer's recommendations, and must be applied to a minimum ³/₈-inch (9.5 mm) thickness in accordance with Section 4.1 of this report.

4.5.2 Without Foam Plastic: The Parex USA Fiber Reinforced Stucco must be applied over gypsum sheathing and steel studs, in accordance with Section 4.3.3, without the foam plastic board.

4.6 Miscellaneous:

4.6.1 Inspection Requirements: Building department inspection is required on lath installation prior to application of the coating, as required by the applicable code.

4.6.2 Control Joints: Control joints must be installed as specified by the architect or designer.

4.6.3 Curing: Moist curing must be provided for a minimum of 24 hours after coating application. The length of time and most effective procedure for moist curing will depend on climatic and job conditions.

4.6.4 Soffits: The system may be applied to soffits, provided the coating is applied over metal lath complying with Section 3.5.2 in lieu of wire fabric lath. Metal lath fastening must comply with IBC Section 2510.3, or 2021, 2018 and 2015 IRC Section R703.7.1 [2012, 2009 and 2006 IRC Section 703.6.1], as applicable, except the fastener length must be increased by the thickness of any substrate.

In the absence of details, conventional three-coat plastering details must be used.

4.6.5 Sills: The systems may be applied to sills at location such as windows and other similar areas. Sills having depths of 6 inches (152 mm) or less may have the coating and lath applied to any substrate permitted in this report, provided the coating, lath, water-resistive barrier and substrate are installed in accordance with the applicable sections of this report. Sills having depths exceeding 6 inches (152 mm) must have substrates of solid wood or plywood. The substrate is fastened in accordance with 2021 IBC Table 2304.10.2, 2018 and 2015 IBC Table 2304.10.1 [2012, 2009 and 2006 IBC Table 2304.9.1] or IRC Section R602.3, as applicable, and a double layer of Grade D water-resistive barrier must be applied over the substrate. The coating, lath and optional foam plastic insulation board must be applied in accordance with Section 4.2 of this report.

5.0 CONDITIONS OF USE:

The Parex USA Fiber Reinforced Stucco (La Habra-Fastwall, La Habra Fastwall One, Teifs One Coat, Parex Amourwall 100, El Rey Fastwall and Merlex Insulex) described in this report comply with, or are suitable alternatives to what is specified in, those codes listed in Section 1.0 of this report, subject to the following conditions:

- 5.1** Materials and methods of installation must comply with this report and the manufacturer's instructions. The manufacturer's published installation instructions must be available at the jobsite at all times during installation. In the event of a conflict between the installation instructions and this report, this report governs.
- 5.2** Installation is by a plastering contractor listed by Parex USA, Inc.
- 5.3** Except as noted in Section 4.5, the coating system is limited to Type V Construction, and structures constructed in accordance with the IRC. The system with metal lath is limited to Type V, or construction permitted by the IRC, except as noted in Section 4.5 of this report. Under the 2021, 2018, 2015 and 2012 IBC, the system is limited to use on exterior walls of buildings having a maximum height of 40 feet (12.2 m) above grade for Types I, II, III and IV construction as indicated in 2021 and 2018 IBC Section 1402.5 [2015 and 2012 IBC Section 1403.5].
- 5.4** The systems are recognized as one-hour fire-resistive assemblies when installation complies with Section 4.4 of this report.
- 5.5** The interior of the building must be separated from the foam plastic insulation board with a thermal barrier complying with the applicable code, such as ¹/₂-inch (12.7 mm) regular gypsum wallboard mechanically attached in accordance with the applicable code.

- 5.6 An installation card, such as that shown in [Figure 3](#), must be left at the jobsite for the owner, and a copy must be filed with the building department.
- 5.7 When installation is in accordance with this report for the La Habra Fastwall 100, Teifs One Coat, Parex Armourwall 100, El Rey Fastwall 100 and Merlex Insulex, the allowable positive and negative wind load for the system installed over wood or steel studs spaced a maximum of 24 inches on center is 32 psf (1532 Pa). Systems installed over steel studs using No. 17 gage by 1½-inch (38 mm) woven-wire fabric lath, or 3.4-pound-per-square-yard (1.29 kg/m²) metal lath, have a 50 psf (2394 Pa) positive and negative allowable wind load. Support framing must be adequate to resist the required wind load and must be designed for a maximum deflection of 1/360 of span.
- 5.8 When installation is in accordance with this report for the La Habra Fastwall One, the allowable positive and negative wind load must comply with Table 1 of this report. Support framing must be adequate to resist the required wind load and must be designed for a maximum deflection of 1/360 of span.
- 5.9 Foam plastic must not be placed on exterior walls of wood construction located within 6 inches (152 mm) of the ground in areas where hazard of termite damage is very heavy in accordance with 2021, 2018 and 2015 IBC Section 2603.8 [2012 IBC Section 2603.9 (2009 and 2006 IBC Section 2603.8)], or 2018, 2015, 2012 and 2009 IRC Section R318 [2006 IRC Section R320.5].

6.0 EVIDENCE SUBMITTED

- 6.1 Data in accordance with the [ICC-ES Acceptance Criteria for Cementitious Exterior Wall Coatings \(AC11\)](#), dated January 2013 (editorially revised September 2020).
- 6.2 Reports of fire tests per ASTM E119.
- 6.3 Noncombustible tests per ASTM E136.
- 6.4 Multi-Story Fire Evaluation per Uniform Building Code™ (UBC) Standard 17-6.

7.0 IDENTIFICATION

- 7.1 The factory-prepared mixes are delivered to the jobsite in water-resistant bags with labels bearing the following information:
 - a. The name and address of Parex USA, Inc., and the evaluation report number (ESR-2564).
 - b. Name of the product.
 - c. Weight of the packaged mix.
 - d. Storage instructions.
 - e. Maximum amount of water and sand that may be added, and conditions that must be considered in determining the actual amounts added.
 - f. Curing instructions.
- 7.2 Foam plastic insulation boards must be identified in accordance with the applicable ICC-ES evaluation report or be suitably listed and produced by a molder that participates in an approved third-party quality control assurance program. Additionally, the board density must be noted. When application is to walls required to be of noncombustible construction (Types I, II, III and IV), one edge of each board, or face of each piece, package or container must bear the foam plastic evaluation report number, the name of Parex USA, Inc., and the evaluation report number (ESR-2564).
- 7.3 The report holder's contact information is the following:

PAREX USA, INC.
2150 EASTRIDGE AVENUE
RIVERSIDE, CALIFORNIA 92507
(866) 516-0061
www.parexusa.com

NOTES:

1. When using sheathing other than foam plastic, these details shall apply. If other than 1" thick substrates are used, grounds must be altered to maintain proper plaster thickness.
2. A water resistive barrier complying to the code, is applied behind the foam substrates and over other substrates.
3. Framing represents metal or wood.
4. Sheathing, framing, water resistive barriers, lath, casing beads and other trlm are "By Others".

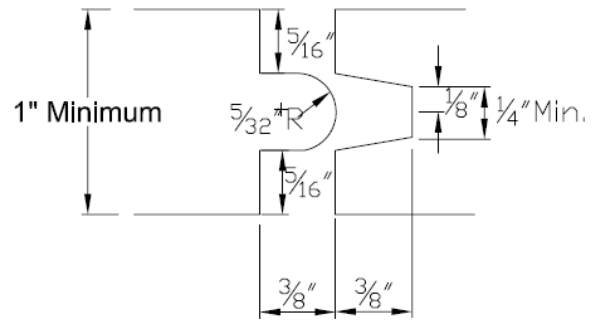

FIGURE 1—TONGUE-AND-GROOVE PROFILE

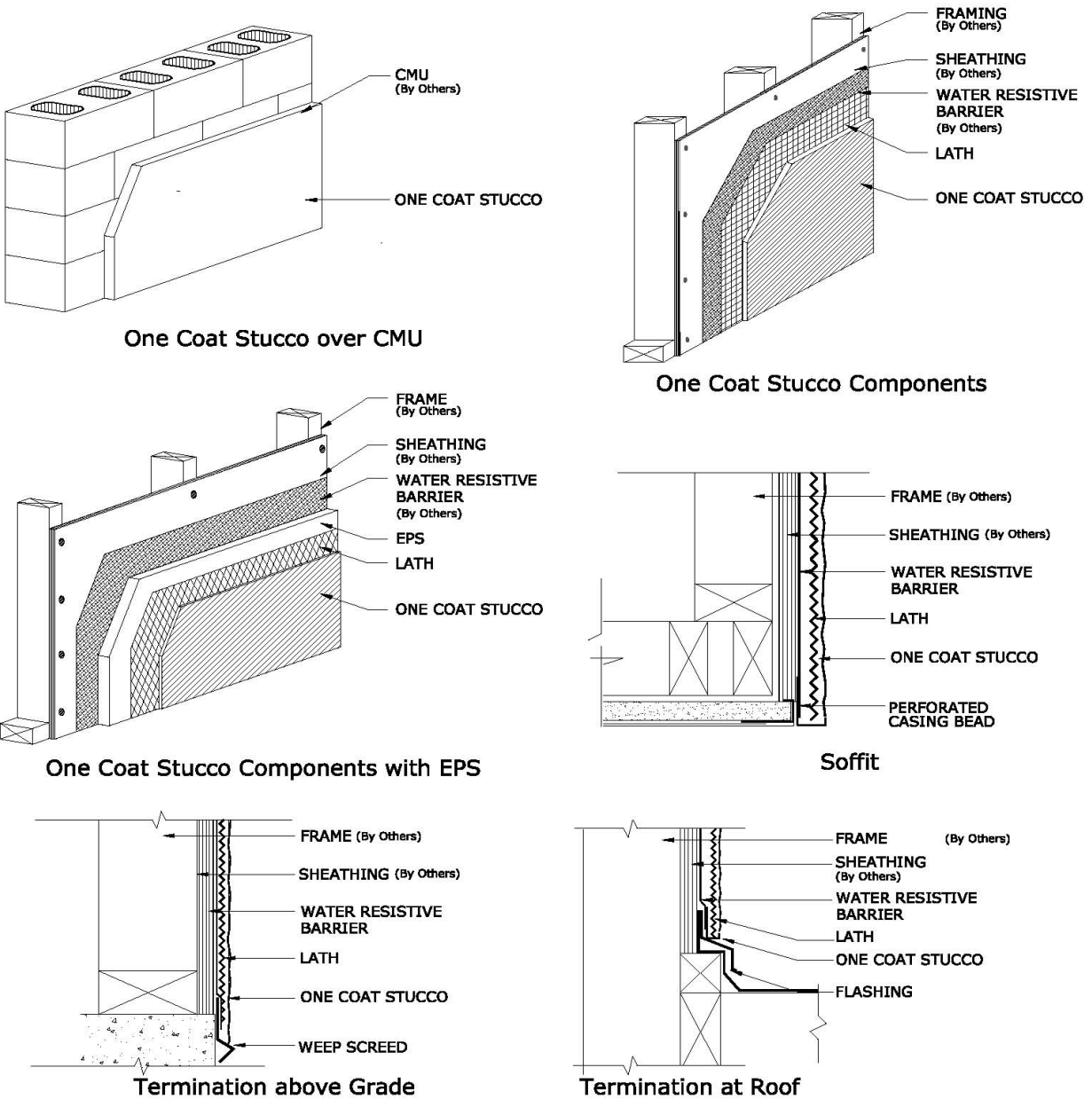
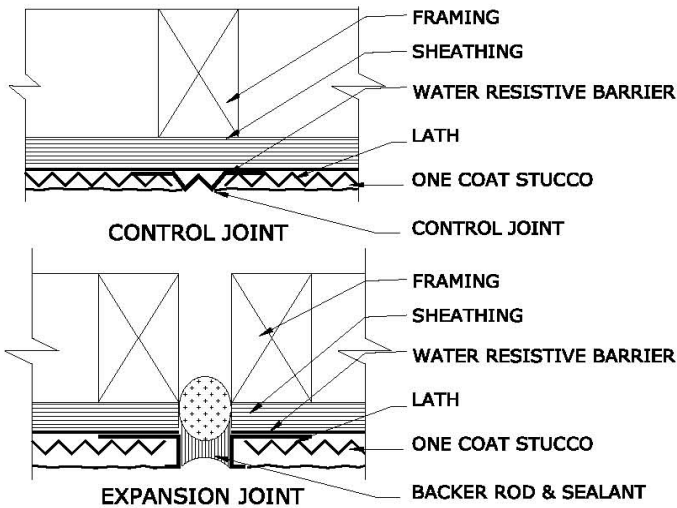
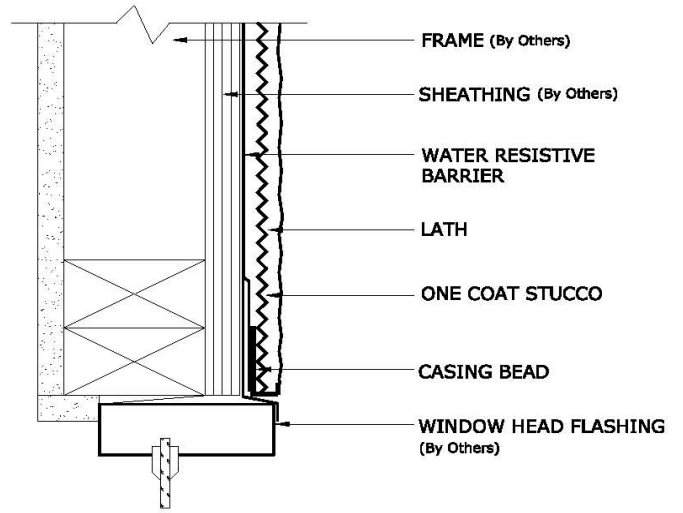

FIGURE 2—TYPICAL INSTALLATION DETAILS



Expansion and Control Joints



Window Head

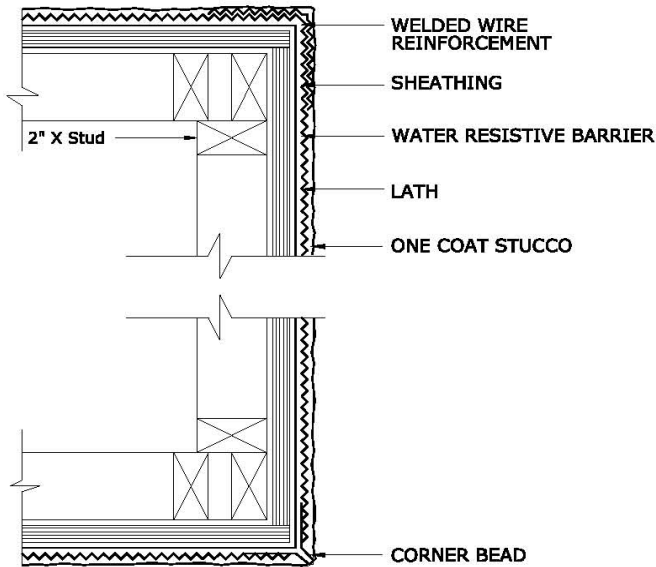

Corners

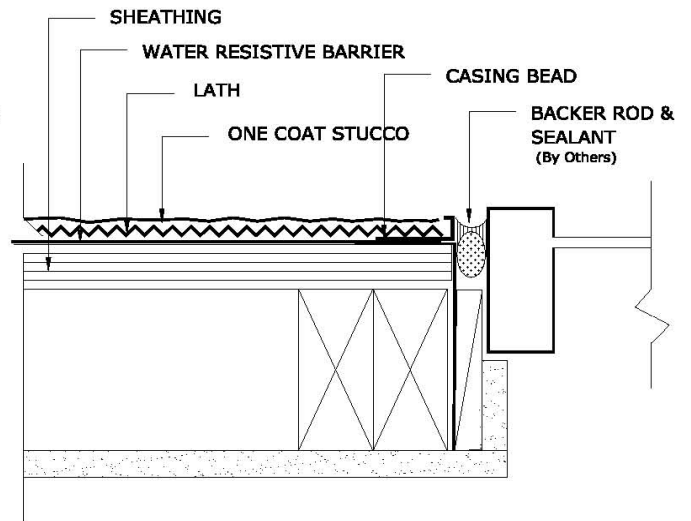

Window Jamb

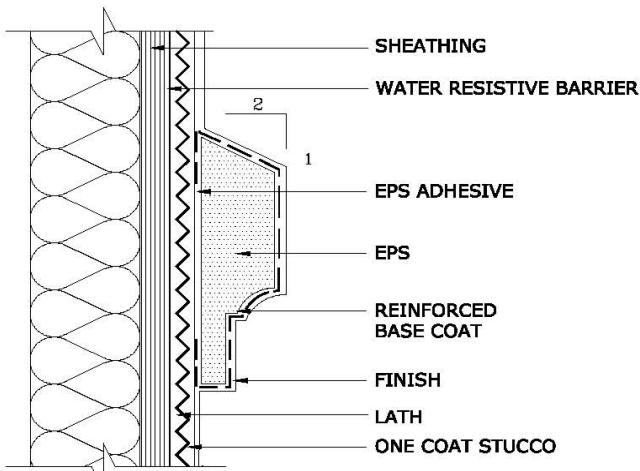

Termination at Deck or Roof

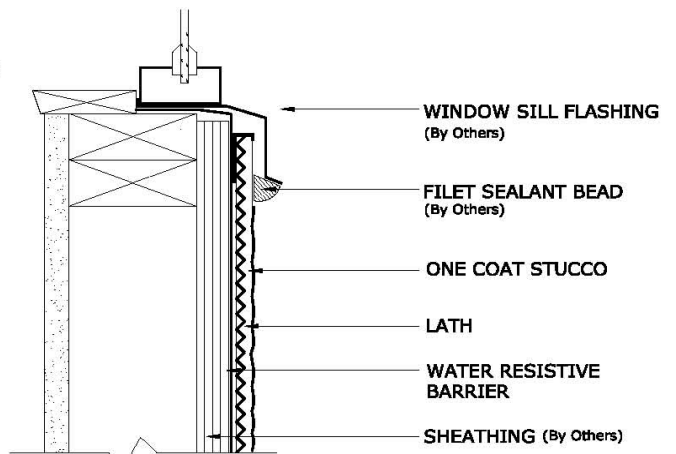

Window Sill

FIGURE 2—TYPICAL INSTALLATION DETAILS (Continued)

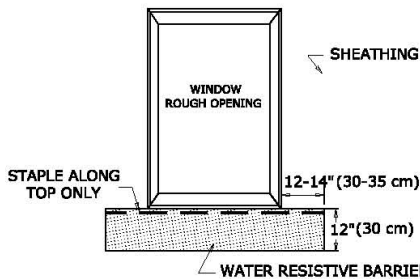

STEP 1: BUILDING PAPER UNDER SILL

Cut water resistive barrier to approximate size shown and staple bottom of the rough opening. **IMPORTANT!** Water resistive barrier should only be stapled along the top edge.

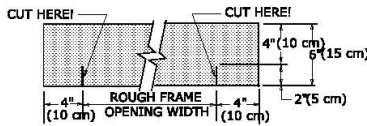

STEP 2: OPTIONAL CUTTING FLASHING MEMBRANE

Cut a piece of flashing membrane 8" (20 cm) longer than the rough opening width. make two small cuts 2" (5 cm) long through the membrane as shown. **NOTE:** 2"x 6" (5 x 15 cm) framing requires 12" (30 cm) wide flashing membrane. Cuts made in the membrane should be 6" (15 cm) long.

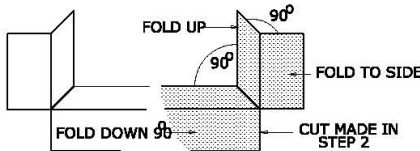

STEP 3 -OPTIONAL: FOLDING FLASHING MEMBRANE

Fold membrane to conform with rough opening. Peel protective backer from membrane, to expose adhesive.

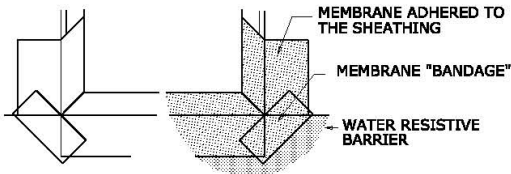

STEP 4 -OPTIONAL: INSTALL FLASHING MEMBRANE

Install the "self sticking" membrane at the rough opening. Membrane should lap over the previously installed "bandages" and water resistive barrier

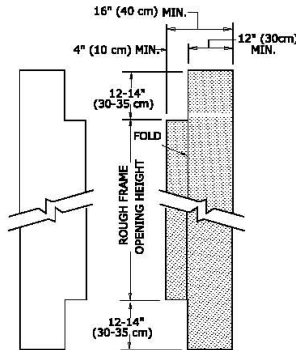

STEP5: CUTTING WEATHER BARRIER FOR JAMBS
Cut water resistive barrier to fit rough opening jamb.

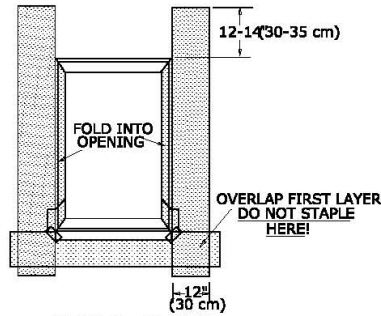

STEP 6: JAMBS

Fold water resistive barrier into rough opening. Bottom leg must overlap first layer as shown. Do not staple immediately below the sill/ jamb corners.

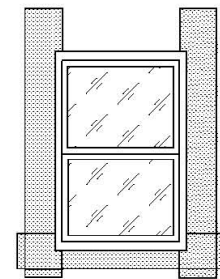

STEP 7: INSTALLING WINDOW

After the strips of water resistive barrier have been installed at the sill and jambs as shown, the window can be installed.

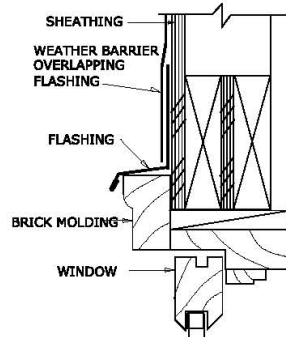

SECTION A-A
WOOD WINDOW WITH BRICK MOLDING

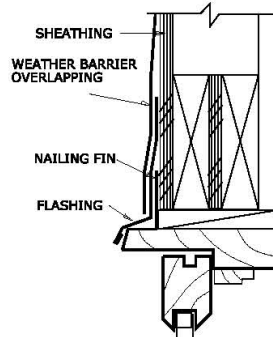

SECTION B-B
WINDOW WITH NAILING FIN

STEP 8: INSTALLATION OF METAL FLASHING

Length of the flashing is dependent on the type of window used. Sections A-A and B-B illustrate two types of windows. Flashing should be installed as illustrated. for any unusual condition please contact Parex Technical Services.

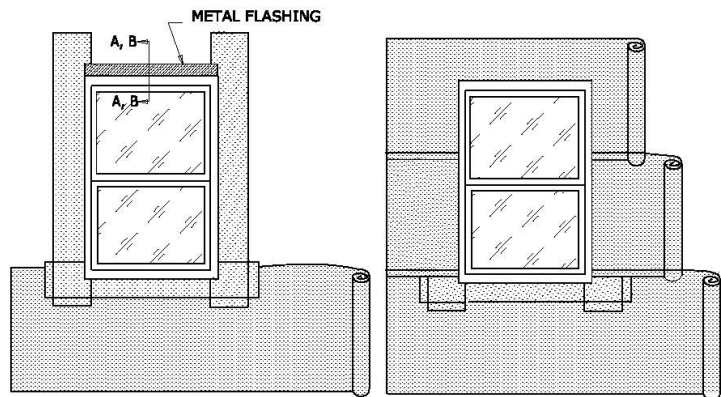

STEP 9 : INSTALLING ROLLS OF WEATHER BARRIER

Install water resistive barrier horizontally in shingle fashion. Each succeeding course overlaps the previous by 2" (5 cm) min. Continue to lap courses as shown for positive drainage. At vertical splices, lap the water resistive barrier a minimum of 6" (15 cm). Vertical splices in the water resistive barrier should not occur within 2' (61 cm) of the window jambs. Succeeding courses lap over the remainder of the water resistive barrier strips and the metal flashing at the head.

NOTE: The previously installed strips at the sill overlaps the horizontally installed water resistive barrier below the sill.

FIGURE 2—TYPICAL INSTALLATION DETAILS (Continued)

INSTALLATION CARD

La Habra Wall or Parex 210-One Coat System

Parex USA, Inc.

Project Address

Evaluation Report ESR-2564

Date Completed _____

Plastering Contractor

Name: _____

Address: _____

Telephone No. () _____

Approved contractor number as issued by Parex La Habra Inc.

This is to certify that the exterior coating system on the building exterior at the above address has been installed in accordance with the evaluation report and the manufacturer's instructions.

Signature of authorized representative of plastering contractor **Date**

FIGURE 3—EXAMPLE OF INSTALLATION CARD

TABLE 1- ALLOWABLE POSITIVE AND NEGATIVE WIND LOAD

Framing	Sheathing	Lath Thickness, inch	Connection of Lath to Framing		Allowable Positive and Negative Transverse Load, psf
			Fastener	Fastener Spacing, inches	
Wood studs @ 24" o.c.	No sheathing and 1/2-inch-thick solid sheathing	1/8	16 ga. X 1.5-inch	4	39
				6	26
			16 ga. X 2-inch	4	55
		6		42	
		1/4	16 ga. X 1.5-inch	4	32
				6	22
	16 ga. X 2-inch		4	55	
		6	38		
	1-inch-thick foam insulation board	1/8	16 ga. X 2-inch	4	40
				6	26
			14 ga. X 2.5-inch	4	70
		6		54	
1/4		16 ga. X 2-inch	4	34	
			6	22	
	14 ga. X 2.5-inch	4	70		
6		49			
Steel Studs @ 24" o.c.	No sheathing and 1/2-inch-thick solid sheathing	N/A	No. 8 x 1.625-inch self-tapping screws	6	44
	1-inch-thick foam insulation board				40

For SI: 1 inch= 25.4 mm; 1 psf=47.88 Pa.

DIVISION: 09 00 00—FINISHES

Section: 09 24 00—Portland Cement Plastering

REPORT HOLDER:

PAREX USA, INC.

EVALUATION SUBJECT:

PAREX USA FIBER REINFORCED STUCCO: LA HABRA-FASTWALL, LA HABRA-FASTWALL ONE, TEIFS ONE COAT, PAREX ARMOURWALL, EL REY FASTWALL AND MERLEX INSULEX

1.0 REPORT PURPOSE AND SCOPE

Purpose:

The purpose of this evaluation report supplement is to indicate that Parex USA Fiber Reinforced Stucco: La Habra-Fastwall, La Habra-Fastwall One, Teifs One Coat, Parex Armourwall, El Rey Fastwall and Merlex Insulex, described in ICC-ES evaluation report [ESR-2564](#), have also been evaluated for compliance with the codes noted below as adopted by the Los Angeles Department of Building and Safety (LADBS).

Applicable code editions:

- 2020 *City of Los Angeles Building Code* ([LABC](#))
- 2020 *City of Los Angeles Residential Code* ([LARC](#))

2.0 CONCLUSIONS

The Parex USA Fiber Reinforced Stucco: La Habra-Fastwall, La Habra-Fastwall One, Teifs One Coat, Parex Armourwall, El Rey Fastwall and Merlex Insulex, described in Sections 2.0 through 7.0 of the evaluation report [ESR-2564](#), comply with the LABC Chapters 25, 26 and the LARC Section R703, and are subjected to the conditions of use described in this supplement.

3.0 CONDITIONS OF USE

The Parex USA Fiber Reinforced Stucco: La Habra-Fastwall, La Habra-Fastwall One, Teifs One Coat, Parex Armourwall, El Rey Fastwall and Merlex Insulex described in this evaluation report supplement must comply with all of the following conditions:

- All applicable sections in the evaluation report [ESR-2564](#).
- The design, installation, conditions of use and identification are in accordance with the 2018 *International Building Code*® (IBC) and the 2018 *International Residential Code*® (IRC) provisions noted in the evaluation report [ESR-2564](#).
- The design and installation are in accordance with additional requirements of LABC Chapter 16, 25 and 26, as applicable.

This supplement expires concurrently with the evaluation report, reissued November 2024.

DIVISION: 09 00 00—FINISHES
Section: 09 24 00—Portland Cement Plastering

REPORT HOLDER:

PAREX USA, INC.

EVALUATION SUBJECT:

PAREX USA FIBER REINFORCED STUCCO: LA HABRA-FASTWALL, LA HABRA-FASTWALL ONE, TEIFS ONE COAT, PAREX ARMOURWALL, EL REY FASTWALL AND MERLEX INSULEX

1.0 REPORT PURPOSE AND SCOPE

Purpose:

The purpose of this evaluation report supplement is to indicate that Parex USA Reinforced Stucco, described in ICC-ES evaluation report ESR-2564, has also been evaluated for compliance with the codes noted below.

Applicable code editions:

- 2019 *California Building Code (CBC)*

For evaluation of applicable chapters adopted by the California Office of Statewide Health Planning and Development (OSHPD) AKA: California Department of Health Care Access and Information (HCAI) and the Division of State Architect (DSA), see Sections 2.1.1 and 2.1.2 below.

- 2019 *California Residential Code (CRC)*

2.0 CONCLUSIONS

2.1 CBC:

The Parex USA Reinforced Stucco, described in Sections 2.0 through 7.0 of the evaluation report ESR-2564, complies with CBC Chapters 25 and 26, provided the design and installation are in accordance with the 2018 *International Building Code*® (IBC) provisions noted in the evaluation report and the additional requirements of CBC Chapters 25 and 26, as applicable.

2.1.1 OSHPD:

The applicable OSHPD Sections of the CBC are beyond the scope of this supplement.

2.1.2 DSA:

The applicable DSA Sections of the CBC are beyond the scope of this supplement.

2.2 CRC:

The Parex USA Reinforced Stucco, described in Sections 2.0 through 7.0 of the evaluation report ESR-2564, complies with CRC Chapter 3 and 7, provided the design and installation are in accordance with the 2018 *International Residential Code*® (IRC) provisions noted in the evaluation report and the additional requirements of CRC Chapters 3 and 7.

This supplement expires concurrently with the evaluation report, reissued November 2024.

DIVISION: 09 00 00—FINISHES

Section: 09 24 00—Portland Cement Plastering

REPORT HOLDER:

PAREX USA, INC.

EVALUATION SUBJECT:

PAREX USA FIBER REINFORCED STUCCO: LA HABRA-FASTWALL, LA HABRA-FASTWALL ONE, TEIFS ONE COAT, PAREX ARMOURWALL, EL REY FASTWALL AND MERLEX INSULEX

1.0 REPORT PURPOSE AND SCOPE

Purpose:

The purpose of this evaluation report supplement is to indicate that Parex USA Fiber Reinforced Stucco, described in ICC-ES evaluation report ESR-2564, has also been evaluated for compliance with the codes noted below.

Applicable code editions:

- 2020 and 2017 *Florida Building Code—Building*
- 2020 and 2017 *Florida Building Code—Residential*

2.0 CONCLUSIONS

The Parex USA Fiber Reinforced Stucco, described in Sections 2.0 through 7.0 of the evaluation report ESR-2564, complies with the *Florida Building Code—Building* and the *Florida Building Code—Residential*, provided the design requirements are determined in accordance with the *Florida Building Code—Building* or the *Florida Building Code—Residential*, as applicable. The installation requirements noted in ICC-ES evaluation report ESR-2564 for the 2018 and 2015 *International Building Code*® meet the requirements of the *Florida Building Code—Building* or the *Florida Building Code—Residential*, as applicable, with the following conditions.

- a) Installation must meet the requirements of Section 1403.8 of the *Florida Building Code—Building* or Section R318.7 of the *Florida Building Code—Residential*, as applicable.
- b) For buildings being designed and constructed to the *Florida Building Code—Residential*, the provisions of Section R301.2.1.1 must be used.

Use of the Parex USA Fiber Reinforced Stucco for compliance with the High-Velocity Hurricane Zone provisions of the *Florida Building Code—Building* and the *Florida Building Code—Residential* has not been evaluated, and is outside the scope of this supplemental report.

For products falling under Florida Rule 61G20-3, verification that the report holder's quality-assurance program is audited by a quality-assurance entity approved by the Florida Building Commission for the type of inspections being conducted is the responsibility of an approved validation entity (or the code official, when the report holder does not possess an approval by the Commission).

This supplement expires concurrently with the evaluation report, reissued November 2024.