

ICC-ES Evaluation Report

ESR-2818

Reissued December 2024

Revised April 2025

Subject to renewal December 2025

This report also contains:



- [City of LA Supplement](#)
- [FL Supplement w/ HVHZ](#)

For references to other reports.

See [ELC-2818](#) for *National Building Code of Canada*® (NBCC)

ICC-ES Evaluation Reports are not to be construed as representing aesthetics or any other attributes not specifically addressed, nor are they to be construed as an endorsement of the subject of the report or a recommendation for its use. There is no warranty by ICC Evaluation Service, LLC, express or implied, as to any finding or other matter in this report, or as to any product covered by the report.

Copyright © 2025 ICC Evaluation Service, LLC. All rights reserved.

<p>DIVISION: 03 00 00— CONCRETE</p> <p>Section: 03 16 00— Concrete Anchors</p> <p>DIVISION: 05 00 00— METALS</p> <p>Section: 05 05 19—Post- Installed Concrete Anchors</p>	<p>REPORT HOLDER: DEWALT</p>  <p>ADDITIONAL LISTEES: THE HILLMAN GROUP</p>	<p>EVALUATION SUBJECT:</p> <p>POWER-STUD®+ SD1 EXPANSION ANCHORS FOR CRACKED AND UNCRACKED CONCRETE (DEWALT)</p>	
--	---	--	---

1.0 EVALUATION SCOPE

Compliance with the following codes:

- 2024, 2021, 2018, and 2015 [International Building Code](#)® (IBC)
- 2024, 2021, 2018, and 2015 [International Residential Code](#)® (IRC)

Main references of this report are for the 2024 IBC and IRC. See [Table 5](#) and [Table 6](#) for applicable sections of the code for previous IBC and IRC editions.

Property evaluated:

- Structural

2.0 USES

The Power-Stud+ SD1 expansion anchors are used as anchorage in cracked and uncracked normal-weight concrete and lightweight concrete having a specified compressive strength, f'_c , of 2,500 psi to 8,500 psi (17.2 MPa to 58.6 MPa) to resist static, wind and seismic tension and shear loads.

The $\frac{3}{8}$ -inch- and $\frac{1}{2}$ -inch-diameter (9.5 mm and 12.7 mm) anchors may be installed in the topside of cracked and uncracked [$\frac{1}{4}$ -inch-diameter (6.4 mm) uncracked only] normal-weight or sand-lightweight concrete-filled steel deck having a specified compressive strength, f'_c , of 2,500 psi to 8,500 psi (17.2 MPa to 58.6 MPa).

The $\frac{3}{8}$ -inch- to $\frac{3}{4}$ -inch-diameter (9.5 mm to 19.1 mm) anchors may be installed in the soffit of cracked and uncracked normal-weight or sand-lightweight concrete-filled steel deck having a minimum specified compressive strength, f'_c , of 3,000 psi (20.7 MPa).

The anchors comply with Section 1901.3 of the 2024 IBC. The anchors may also be used where an engineered design is submitted in accordance with Section R301.1.3 of the IRC.

3.0 DESCRIPTION

3.1 Power-Stud+ SD1:

Power-Stud+ SD1 expansion anchors are torque-controlled, mechanical expansion anchors comprised of an anchor body, expansion wedge (clip), washer and hex nut. Product names corresponding to report holder and additional listees are presented in the following table.

COMPANY NAME	PRODUCT NAME
DEWALT	Power-Stud+ SD1
The Hillman Group	Hillman Power-Stud+ SD1
	Power Pro SD1 Wedge Anchor

Available diameters are 1/4 inch, 3/8 inch, 1/2 inch, 5/8 inch, 3/4 inch, 7/8 inch, 1 inch, and 1 1/4 inch (6.4 mm, 9.5 mm, 12.7 mm, 15.9 mm, 19.1 mm, 22.0 mm, 25.4 mm and 31.8 mm). The anchor body and expansion clip are manufactured from medium carbon steel complying with requirements set forth in the approved quality documentation, and have minimum 0.0002-inch-thick (5 µm) zinc plating in accordance with ASTM B633, SC1, Type III. The washers comply with ASTM F844. The hex nuts comply with ASTM A563, Grade A. The Power-Stud+ SD1 expansion anchor is illustrated in [Figure 2](#).

The anchor body is comprised of a high-strength threaded rod at one end and a tapered mandrel at the other end. The tapered mandrel is enclosed by a three-section expansion clip that freely moves around the mandrel. The expansion clip movement is restrained by the mandrel taper and by a collar. The anchors are installed in a predrilled hole with a hammer. When torque is applied to the nut of the installed anchor on the threaded end of the anchor body, the mandrel at the opposite end of the anchor is drawn into the expansion clip, forcing it outward into the sides of the predrilled hole in the base material.

3.2 Concrete:

Normal-weight and lightweight concrete must comply with Sections 1903 and 1905 of the 2024 IBC as applicable.

3.3 Steel Deck Panels:

Steel deck panels must comply with the configuration in [Figure 4](#), [Figure 5A](#) and [Figure 5B](#) and have a minimum base steel thickness of 0.035 inch (0.889 mm) [No. 20 gage]. Steel must comply with ASTM A653/A653M SS Grade 33, and have a minimum yield strength of 33 ksi (228 MPa).

4.0 DESIGN AND INSTALLATION

4.1 Strength Design:

4.1.1 General: Design strength of anchors complying with the 2024 IBC, as well as Section R301.1.3 of the 2024 IRC must be determined in accordance with ACI 318-19 Chapter 17 and this report.

Design examples according to the 2024 IBC are given in [Figure 6](#) of this report.

Design parameters provided in [Tables 1](#), [2](#), and [3](#) and references to ACI 318 are based on the 2024 IBC (ACI 318-19), unless noted otherwise in Sections 4.1.1 through 4.1.12 of this report. The strength design of anchors must comply with ACI 318-19 Section 17.5.1.2, except as required in ACI 318-19 Section 17.10. Strength reduction factors, ϕ , as given in ACI 318-19 Section 17.5.3, and noted in [Tables 2](#) and [3](#) of this report, must be used for load combinations calculated in accordance with Section 1605.1 of the 2024 IBC. Strength reduction factors, ϕ , corresponding to ductile steel elements are appropriate.

4.1.2 Requirements for Static Steel Strength in Tension, N_{sa} : The nominal static steel strength of a single anchor in tension, N_{sa} , calculated in accordance with ACI 318-19 Section 17.6.1.2, is given in [Table 2](#) of this report. Strength reduction factors, ϕ , corresponding to ductile steel elements may be used.

4.1.3 Requirements for Static Concrete Breakout Strength in Tension, N_{cb} or N_{cbg} : The nominal concrete breakout strength of a single anchor or a group of anchors in tension, N_{cb} and N_{cbg} , respectively must be calculated in accordance with ACI 318-19 Section 17.6.2, with modifications as described in this section. The basic concrete breakout strength in tension, N_b , must be calculated in accordance with ACI 318-19 Section 17.6.2.2, using the values of h_{ef} and k_{cr} as given in [Table 2](#) of this report. The nominal concrete breakout strength in tension in regions where analysis indicates no cracking in accordance with ACI 318-19 Section 17.6.2.5.1(a) must be calculated with the value of k_{uncr} as given in [Table 2](#) and with $\psi_{c,N} = 1.0$.

For anchors installed in the soffit of sand-lightweight or normal-weight concrete-filled steel deck floor and roof assemblies, as shown in [Figure 5A](#) and [Figure 5B](#), calculation of the concrete breakout strength in accordance with ACI 318-19 Section 17.6.2 is not required.

4.1.4 Requirements for Static Pullout Strength in Tension, N_{pn} : The nominal pullout strength of a single anchor in accordance with ACI 318-19 Sections 17.6.3.1 and 17.6.3.2.1 in cracked and uncracked concrete, $N_{p,cr}$ and $N_{p,uncr}$, respectively, is given in [Table 2](#). In lieu of ACI 318-19 Section 17.6.3.3, $\psi_{c,P} = 1.0$ for all design cases. The nominal pullout strength in cracked concrete may be adjusted by calculations according to Eq-1:

$$N_{pn,f'_c} = N_{p,cr} \left(\frac{f'_c}{2,500} \right)^{0.5} \quad (\text{lb, psi}) \quad (\text{Eq-1})$$

$$N_{pn,f'_c} = N_{p,cr} \left(\frac{f'_c}{17.2} \right)^{0.5} \quad (\text{N,MPa})$$

where f'_c is the specified concrete compressive strength.

In regions where analysis indicates no cracking in accordance with ACI 318-19 Section 17.6.3.3, the nominal pullout strength in tension can be adjusted by calculations according to Eq-2:

$$N_{pn,f'_c} = N_{p,uncr} \left(\frac{f'_c}{2,500} \right)^{0.5} \quad (\text{lb, psi}) \quad (\text{Eq-2})$$

$$N_{pn,f'_c} = N_{p,uncr} \left(\frac{f'_c}{17.2} \right)^{0.5} \quad (\text{N,MPa})$$

where f'_c is the specified concrete compressive strength.

Where values for $N_{p,cr}$ or $N_{p,uncr}$ are not provided in [Table 2](#) of this report, the pullout strength in tension need not be evaluated.

The nominal pullout strength in tension for anchors installed in the soffit of sand-lightweight or normal weight concrete-filled steel deck floor and roof assemblies, as shown in [Figure 5A](#) and [Figure 5B](#), is provided in [Table 2](#). In accordance with ACI 318-19 Section 17.6.3.2.1, the nominal pullout strength in cracked concrete must be calculated according to Eq-1, whereby the value of $N_{p,deck,cr}$ must be substituted for $N_{p,cr}$ and the value of 3,000 psi (20.7 MPa) must be substituted for the value of 2,500 psi (17.2 MPa) in the denominator. In regions where analysis indicates no cracking in accordance with ACI 318-19 Section 17.6.3.3, the nominal strength in uncracked concrete must be calculated according to Eq-2, whereby the value of $N_{p,deck,uncr}$ must be substituted for $N_{p,uncr}$, and the value of 3,000 psi (20.7 MPa) must be substituted for the value of 2,500 psi (17.2 MPa) in the denominator.

4.1.5 Requirements for Static Steel Strength in Shear, V_{sa} : The nominal steel strength in shear, V_{sa} , of a single anchor in accordance with ACI 318-19 Section 17.7.1.2 is given in [Table 3](#) of this report and must be used in lieu of the values derived by calculation from ACI 318-19 Eq. 17.7.1.2b. The strength reduction factor, ϕ , corresponding to a ductile steel element must be used for all anchors, as described in [Table 3](#) of this report.

The shear strength $V_{sa,deck}$ of anchors installed in the soffit of sand-lightweight or normal-weight concrete on steel deck floor and roof assemblies, as shown in [Figure 5A](#) and [Figure 5B](#), is given in [Table 3](#) of this report in lieu of the values derived by calculation from ACI 318-19 Eq. 17.7.1.2b.

4.1.6 Requirements for Static Concrete Breakout Strength in Shear, V_{cb} or V_{cbg} : The nominal concrete breakout strength of a single anchor or group of anchors in shear, V_{cb} or V_{cbg} , respectively, must be calculated in accordance with ACI 318-19 Section 17.7.2, with modifications as described in this section. The basic concrete breakout strength in shear, V_b , must be calculated in accordance with ACI 318-19 Section 17.7.2.2.1, using the values of l_e and d_a given in [Table 3](#) of this report.

For anchors installed in the topside of concrete-filled steel deck assemblies, the nominal concrete breakout strength of a single anchor or group of anchors in shear, V_{cb} or V_{cbg} , respectively, must be calculated in accordance with ACI 318-19 Section 17.7.2.1, using the actual member topping thickness, $h_{min,deck}$, in the determination of A_{vc} . Minimum member topping thickness for anchors in the topside of concrete-filled steel deck assemblies is given in [Table 1](#) of this report.

For anchors installed in the soffit of sand-lightweight or normal-weight concrete-filled steel deck floor and roof assemblies, as shown in [Figure 5A](#) and [Figure 5B](#), calculation of the concrete breakout strength in accordance with ACI 318-19 Section 17.7.2 is not required.

4.1.7 Requirements for Static Concrete Pryout Strength in Shear, V_{cp} or V_{cpg} : The nominal concrete pryout strength of a single anchor or group of anchors in shear, V_{cp} or V_{cpg} , respectively, must be calculated in accordance with ACI 318-19 Section 17.7.3, modified by using the value of k_{cp} provided in [Table 3](#) and the value of N_{cb} or N_{cbg} as calculated in Section 4.1.3 of this report.

For anchors installed in the soffit of sand-lightweight or normal-weight concrete-filled steel deck floor and roof assemblies, as shown in [Figure 5A](#) and [Figure 5B](#), calculation of the concrete pryout strength in accordance with ACI 318-19 Section 17.7.3 is not required.

4.1.8 Requirements for Seismic Design:

4.1.8.1 General: For load combinations including seismic loads, the design must be performed in accordance with ACI 318-19 Section 17.10. Modifications to ACI 318-19 Section 17.10 must be applied under Section 1905.7 of the 2024 IBC.

The anchors comply with ACI 318-19 Section 2.3 as ductile steel elements and must be designed in accordance with ACI 318-19 Sections 17.10.4, 17.10.5, 17.10.6, and 17.10.7. Strength reduction factors, ϕ , are given in [Tables 2](#) and [3](#) of this report. The $1/4$ -inch-diameter (6.4 mm) anchors must be limited to installation in structures assigned to IBC Seismic Design Categories A and B only. The $3/8$ -inch-diameter (9.5 mm), $1/2$ -inch-diameter (12.7 mm), $5/8$ -inch-diameter (15.9 mm), $3/4$ -inch-diameter (19.1 mm), $7/8$ -inch-diameter (22.2 mm), 1-inch-diameter (25.4 mm) and $1 1/4$ -inch-diameter (31.8 mm) anchors may be installed in structures assigned to IBC Seismic Design Categories A to F.

4.1.8.2 Seismic Tension: The nominal steel strength and nominal concrete breakout strength for anchors in tension must be calculated in accordance with ACI 318-19 Sections 17.6.1 and 17.6.2, respectively, as applicable, as described in Sections 4.1.2 and 4.1.3 of this report. In accordance with ACI 318-19 Section 17.6.3.2.1, the appropriate value for pullout strength in tension for seismic loads, $N_{p,eq}$, described in [Table 2](#) must be used in lieu of N_p . $N_{p,eq}$ may be adjusted by calculations for concrete compressive strength in accordance with Eq-1 of this report.

For anchors installed in the soffit of sand-lightweight or normal-weight concrete-filled steel deck floor and roof assemblies, the nominal pullout strength in tension for seismic loads, $N_{p,deck,eq}$, is provided in [Table 2](#) and must be used in lieu of $N_{p,cr}$. $N_{p,deck,eq}$ may be adjusted by calculations for concrete compressive strength in accordance with Eq-1 of this report where the value of 3,000 psi (20.7 MPa) must be substituted for the value of 2,500 psi (17.2 MPa) in the denominator.

Where values for $N_{p,eq}$ or $N_{p,deck,eq}$, are not provided in [Table 2](#) of this report, the pullout strength in tension for seismic loads does not govern and need not be evaluated.

Seismic Shear: The nominal concrete breakout strength and concrete pryout strength for anchors in shear must be calculated according to ACI 318-19 Sections 17.7.2 and 17.7.3, respectively, as applicable, as described in Sections 4.1.6 and 4.1.7. In accordance with ACI 318-19 Section 17.7.1.2 the appropriate value for nominal steel strength in shear for seismic loads, $V_{sa,eq}$, described in [Table 3](#) must be used in lieu of V_{sa} .

For anchors installed in the soffit of sand-lightweight or normal-weight concrete-filled steel deck floor and roof assemblies, as shown in [Figure 5A](#) and [Figure 5B](#), the appropriate value for nominal steel strength in shear for seismic loads, $V_{sa,deck,eq}$, described in [Table 3](#) must be used in lieu of V_{sa} .

4.1.9 Requirements for Interaction of Tensile and Shear Forces: Anchors or groups of anchors that are subject to the effects of combined axial (tensile) and shear forces must be designed in accordance with ACI 318-19 Section 17.8.

4.1.10 Requirements for Critical Edge Distance: In applications where $c < c_{ac}$ and supplemental reinforcement to control splitting of the concrete is not present, the concrete breakout strength in tension for uncracked concrete, calculated according to ACI 318-19 Section 17.6.2, must be further multiplied by the factor $\psi_{cp,N}$ given by Eq-3:

$$\psi_{cp,N} = \frac{c}{c_{ac}} \quad (\text{Eq-3})$$

where the factor $\psi_{cp,N}$ need not be taken as less than $\frac{1.5h_{ef}}{c_{ac}}$. For all other cases, $\psi_{cp,N} = 1.0$. In lieu of using ACI 318-19 Section 17.9.5, values of c_{ac} must comply with [Table 1](#) of this report.

4.1.11 Requirements for Minimum Member Thickness, Minimum Anchor Spacing and Minimum Edge Distance: In lieu of ACI 318-19 Section 17.9.2, values of c_{min} and s_{min} must comply with [Table 1](#). In lieu of ACI 318-19 Section 17.9.4, minimum member thicknesses, h_{min} or $h_{min,deck}$, must comply with [Table 1](#). Additional combinations of minimum member thickness, h_{min} , and spacing, s_{min} , may be derived by linear interpolation between the given boundary values.

For anchors installed in the topside of concrete-filled steel deck assemblies, the anchors must be installed in accordance with [Table 1](#) and [Figure 4](#) of this report.

For anchors installed through the soffit of steel deck assemblies, the anchors must be installed in accordance with [Figure 5A](#) and [Figure 5B](#) and must have an axial spacing along the flute equal to the greater of $3h_{ef}$ or 1.5 times the flute width.

4.1.12 Lightweight Concrete: For the use of anchors in lightweight concrete, the modification factor λ_a equal to 0.8 λ is applied to all values of $\sqrt{f'_c}$ affecting N_n and V_n .

The value of λ must be determined in accordance with ACI 318-19.

For anchors installed in the soffit of sand-lightweight concrete-filled steel deck and floor and roof assemblies, further reduction of the pullout values provided in this report is not required.

4.2 Allowable Stress Design (ASD):

4.2.1 General: Where design values for use with allowable stress design (working stress design) load combinations in accordance with Section 1605.1 of the 2024 IBC are required these are calculated using Eq-4 and Eq-5 as follows:

$$T_{allowable,ASD} = \frac{\phi N_n}{\alpha} \quad (\text{Eq-4})$$

$$V_{allowable,ASD} = \frac{\phi V_n}{\alpha} \quad (\text{Eq-5})$$

where:

$$T_{allowable,ASD} = \text{Allowable tension load (lbf or kN)}$$

$$V_{allowable,ASD} = \text{Allowable shear load (lbf or kN)}$$

$$\phi N_n = \text{Lowest design strength of an anchor or anchor group in tension as determined in accordance with ACI 318-19 Chapter 17 and 2024 IBC Section 1905.7, and Section 4.1 of this report, as applicable (lbf or N).}$$

$$\phi V_n = \text{Lowest design strength of an anchor or anchor group in shear as determined in accordance with ACI 318-19 Chapter 17 and 2024 IBC Section 1905.7, and Section 4.1 of this report, as applicable (lbf or N).}$$

$$\alpha = \text{Conversion factor calculated as a weighted average of the load factors for the controlling load combination. In addition, } \alpha \text{ must include all applicable factors to account for nonductile failure modes and required over-strength.}$$

The requirements for member thickness, edge distance and spacing, described in this report, must apply. An example of allowable stress design values for illustrative purposes is shown in [Table 4](#) and [Figure 6](#).

4.2.2 Interaction of Tensile and Shear Forces: The interaction must be calculated and consistent with ACI 318-19 Section 17.8 as follows:

For shear loads $V_{applied} \leq 0.2 V_{allowable,ASD}$, the full allowable load in tension shall be permitted.

For tension loads $T_{applied} \leq 0.2 T_{allowable,ASD}$, the full allowable load in shear shall be permitted.

For all other cases Eq-6 applies:

$$\frac{T_{applied}}{T_{allowable,ASD}} + \frac{V_{applied}}{V_{allowable,ASD}} \leq 1.2 \quad (\text{Eq-6})$$

4.3 Installation:

Installation parameters are provided in [Table 1](#) and [Figures A, 1, 3, 4, 5A](#) and [5B](#) of this report. Anchor locations must comply with this report and the plans and specifications approved by the code official. The Power-Stud+SD1 expansion anchors must be installed in accordance with the manufacturer's printed installation instructions and this report. Anchors must be installed in holes drilled into the concrete using carbide-tipped masonry drill bits complying with ANSI B212.15-1994. The nominal drill bit diameter must be equal to that of the anchor. The minimum drilled hole depth is given in [Table 1](#), [Figure 4](#), [Figure 5A](#) and [Figure 5B](#). Prior to anchor installation, remove dust and debris from the hole during drilling (e.g. dust extractor, hollow bit) or following drilling (e.g. suction, forced air) to extract loose particles created by drilling (see [Figures 3](#) and [A](#)). The anchor must be hammered into the predrilled hole until the proper nominal embedment depth is achieved. The nut must be tightened against the washer until the torque values specified in [Table 1](#) are achieved.

For installation in the topside of concrete-filled steel deck assemblies, installations must comply with [Figure 4](#).

For installation in the soffit of concrete on steel deck assemblies, the hole diameter in the steel deck must be no more than 1/8-inch (3.2 mm) larger than the diameter of the hole in the concrete. Member thickness and edge distance restrictions for installations into the soffit of concrete on steel deck assemblies must comply with [Figure 5A](#) and [Figure 5B](#).

4.4 Special Inspection:

Periodic special inspection is required in accordance with Section 1705.1.1 and Table 1705.3 of the 2024 IBC, as applicable. The special inspector must make periodic inspections during anchor installation to verify anchor type, anchor dimensions, concrete type, concrete compressive strength, drill bit type, hole dimensions, hole cleaning procedure, concrete member thickness, anchor embedment, anchor spacing, edge distances,

tightening torque and adherence to the manufacturer's printed installation instructions. The special inspector must be present as often as required in accordance with the "statement of special inspection".

5.0 CONDITIONS OF USE:

The Power-Stud+ SD1 expansion anchors described in this report comply with, or are suitable alternatives to what is specified in, those codes listed in Section 1.0 of this report, subject to the following conditions:

- 5.1 The anchors must be installed in accordance with the manufacturer's printed installation instructions and this report. In case of conflict, this report governs.
- 5.2 Anchor sizes, dimensions, and minimum embedment depths are as set forth in this report.
- 5.3 The 1/4-inch (6.4 mm) anchors must be installed in uncracked normal-weight or lightweight concrete; 3/8-inch to 1 1/4-inch anchors (9.5 mm to 31.8 mm) must be installed in cracked or uncracked normal-weight or lightweight concrete having a specified compressive strength, f'_c , of 2,500 psi to 8,500 psi (17.2 MPa to 58.6 MPa).
- 5.4 The 3/8-inch and 1/2-inch (9.5 mm to 12.7 mm) anchors must be installed in the topside of cracked and uncracked [1/4-inch-diameter (6.4 mm) uncracked only] normal-weight or sand-lightweight concrete-filled steel deck having a specified compressive strength, f'_c , of 2,500 psi to 8,500 psi (17.2 MPa to 58.6 MPa).
- 5.5 The 3/8-inch to 3/4-inch anchors (9.5 mm and 19.1 mm) must be installed in the soffit of cracked and uncracked normal-weight or sand-lightweight concrete-filled steel deck having a minimum specified compressive strength, f'_c , of 3,000 psi (20.7 MPa).
- 5.6 The concrete must have attained its minimum design strength prior to installation of the anchors.
- 5.7 The values of f'_c used for calculation purposes must not exceed 8,000 psi (55.2 MPa).
- 5.8 Strength design values must be established in accordance with Section 4.1 of this report.
- 5.9 Allowable stress design values must be established in accordance with Section 4.2 of this report.
- 5.10 Anchor spacing(s) and edge distance(s), as well as minimum member thickness, must comply with [Table 1](#), [Figure 4](#), [Figure 5A](#) and [Figure 5B](#) of this report, unless otherwise noted.
- 5.11 Prior to installation, calculations and details demonstrating compliance with this report must be submitted to the code official. The calculations and details must be prepared by a registered design professional where required by the statutes of the jurisdiction in which the project is to be constructed.
- 5.12 Since an ICC-ES acceptance criteria for evaluating data to determine the performance of anchors subjected to fatigue or shock loading is unavailable at this time, the use of these anchors under such conditions is beyond the scope of this report.
- 5.13 Anchors [except 1/4-inch-diameter (6.4 mm)] may be installed in regions of concrete where cracking has occurred or where analysis indicates cracking may occur ($f_t > f_r$), subject to the conditions of this report.
- 5.14 The 1/4-inch-diameter (6.4 mm) anchors may be used to resist short-term loading due to wind forces, and for seismic load combinations limited to structures assigned to Seismic Design Categories A and B, under the IBC, subject to the conditions of this report. The 3/8-inch- to 1 1/4-inch-diameter (9.5 mm to 31.8 mm) anchors may be used to resist short-term loading due to wind or seismic forces in structures assigned to Seismic Design Categories A through F, under the IBC, subject to the conditions of this report.
- 5.15 Where not otherwise prohibited in the code, Power-Stud+ SD1 expansion anchors are permitted for use with fire-resistance-rated construction provided that at least one of the following conditions is fulfilled:
 - The anchors are used to resist wind or seismic forces only.
 - Anchors that support a fire-resistance-rated envelope or a fire-resistance-rated membrane are protected by approved fire-resistance-rated materials, or have been evaluated for resistance to fire exposure in accordance with recognized standards.
 - Anchors are used to support nonstructural elements.
- 5.16 Use of carbon steel anchors is limited to dry, interior locations.
- 5.17 Special inspection must be provided in accordance with Section 4.4 of this report.
- 5.18 Anchors are manufactured under an approved quality-control program with inspections by ICC-ES.

6.0 EVIDENCE SUBMITTED

Data in accordance with the [ICC-ES Acceptance Criteria for Mechanical Anchors in Concrete Elements AC193 \(24a\)](#), published April 2025, which incorporates requirements in ACI 355.2 (-19 and -07), for use in cracked and uncracked concrete; including optional service-condition Test 18 and Test 19 (AC193, Annex 1, Table 4.2) for seismic tension and shear; and quality control documentation.

7.0 IDENTIFICATION

- 7.1 The ICC-ES mark of conformity, electronic labeling, or the evaluation report number (ICC-ES ESR-2818) along with the name, registered trademark, or registered logo of the report holder and/or listee must be included in the product label.
- 7.2 The Power-Stud+ SD1 expansion anchors are identified by dimensional characteristics and packaging. A length letter code is stamped on each anchor on the exposed threaded stud end which is visible after installation. [Table A](#) summarizes the length code identification system. A plus sign “+” is also marked with the number “1” on all anchors with the exception of the 1/4-inch-diameter (6.4 mm) anchors. Packages are identified with the product name, type and size and the company name as set forth in Section 3.1 of this report.
- 7.3 The report holder’s contact information is the following:

DEWALT
701 EAST JOPPA ROAD
TOWSON, MARYLAND 21286
(800) 524-3244
www.DEWALT.com
anchors@DEWALT.com

- 7.4 The additional listees’ contact information is the following:

THE HILLMAN GROUP
1280 KEMPER MEADOW DRIVE
CINCINNATI, OHIO 45240
info@hillmangroup.com

TABLE 1—POWER-STUD+ SD1 ANCHOR INSTALLATION SPECIFICATIONS IN CONCRETE AND INTO CONCRETE-FILLED STEEL DECK ASSEMBLIES¹

Anchor Property / Setting Information	Notation	Units	Nominal Anchor Diameter																			
			1/4 inch	3/8 inch	1/2 inch		5/8 inch		3/4 inch		7/8 inch	1 inch	1 1/4 inch									
Anchor diameter	d_a	in. (mm)	0.250 (6.4)	0.375 (9.5)	0.500 (12.7)		0.625 (15.9)		0.750 (19.1)		0.875 (22.2)	1.00 (25.4)	1.25 (31.8)									
Minimum diameter of hole clearance in fixture	d_h	in. (mm)	5/16 (7.5)	7/16 (11.1)	9/16 (14.3)		1 1/16 (17.5)		1 3/16 (20.6)		1 (25.4)	1 1/8 (28.6)	1 3/8 (34.9)									
Nominal drill bit diameter (ANSI)	d_{bit}	in. ANSI	1/4	3/8	1/2		5/8		3/4		7/8	1	1 1/4									
Nominal embedment depth	h_{nom}	in. (mm)	1 3/4 (44)	2 3/8 (60)	2 1/2 (64)	3 3/4 (95)	3 3/8 (86)	4 5/8 (117)	4 (102)	5 5/8 (143)	4 1/2 (114)	5 1/2 (140)	6 1/2 (165)									
Effective embedment depth	h_{ef}	in. (mm)	1.50 (38)	2.00 (51)	2.00 (51)	3.25 (83)	2.75 (70)	4.00 (102)	3.125 (79)	4.75 (114)	3.50 (89)	4.375 (111)	5.375 (137)									
Minimum hole depth	h_{hole}	in. mm	1 7/8 (48)	2 1/2 (64)	2 3/4 (70)	4 (102)	3 3/4 (95)	5 (127)	4 1/4 (108)	5 7/8 (149)	4 7/8 (124)	5 7/8 (149)	7 1/4 (184)									
Minimum overall anchor length ²	ℓ_{anch}	in. mm	2 1/4 (57)	2 3/4 (70)	3 3/4 (95)	4 1/2 (114)	4 1/2 (114)	6 (152)	6 (152)	7 (178)	6 (152)	9 (229)	9 (229)									
Installation torque ⁶	T_{inst}	ft.-lbf. (N-m)	4 (5)	20 (27)	40 (54)		80 (108)		110 (149)		175 (237)	225 (305)	375 (508)									
Torque wrench/socket size	-	in. mm	7/16	9/16	3/4		15/16		1 1/8		1 5/16	1 1/2	1 7/8									
Hex nut height	-	in. mm	7/32	2 1/64	7/16		35/64		4 1/64		3/4	55/64	1 1/16									
Anchors Installed in Concrete																						
Minimum member thickness	h_{min}	in. (mm)	3/4 (83)	3 3/4 (95)	4 (102)	4 (102)	6 (152)	6 (152)	7 (178)	6 (152)	10 (254)	10 (254)	10 (254)	12 (305)								
Minimum edge distance	c_{min}	in. (mm)	1 3/4 (44)	6 (152)	2 3/4 (70)	2 1/4 (57)	6 (152)	3 1/4 (95)	4 (102)	2 3/4 (70)	6 (152)	5 1/2 (140)	4 1/4 (108)	5 (127)	6 (152)	7 (178)	8 (203)	8 (203)				
Minimum spacing distance	s_{min}	in. (mm)	2 1/4 (57)	3 1/2 (89)	2 9 (95)	3 3/4 (95)	4 1/2 (114)	10 (254)	5 (127)	6 (152)	6 (152)	11 (270)	4 1/4 (108)	6 (152)	6 1/2 (165)	6 1/2 (165)	8 (203)	8 (203)				
Critical edge distance (uncracked concrete only)	c_{ac}	in. (mm)	3 1/2 (89)	6 1/2 (165)		8 (203)		8 (203)		6 (152)		10 (254)	11 (279)	16 (406)	11 1/2 (292)	12 (305)	20 (508)					
Anchors Installed in the Topside of Concrete-filled Steel Deck Assemblies^{3,4}																						
Minimum member topping thickness	$h_{min,deck}$	in. (mm)	3/4 (83)	3 1/4 (83)	3 1/4 (83)	See Note 3		See Note 3		See Note 3		See Note 3		See Note 3		See Note 3						
Minimum edge distance	$c_{min,deck,top}$	in. (mm)	1 3/4 (44)	2 3/4 (70)	4 1/2 (114)																	
Minimum spacing distance	$s_{min,deck,top}$	in. (mm)	2 1/4 (57)	4 (102)	6 1/2 (165)																	
Critical edge distance (uncracked concrete only)	$c_{ac,deck,top}$	in. (mm)	3 1/2 (89)	6 1/2 (165)	6 (152)																	
Anchors Installed Through the Soffit of Steel Deck Assemblies into Concrete^{5,6}																						
Minimum member topping thickness (see detail in Figure 5A)	$h_{min,deck}$	in. (mm)	Not Applicable	3 1/4 (83)	3 1/4 (83)	3 1/4 (83)	Not Applicable		Not Applicable		Not Applicable		Not Applicable		Not Applicable		Not Applicable					
Minimum edge distance, lower flute (see detail in Figure 5A)	c_{min}	in. (mm)		1 1/4 (32)	1 1/4 (32)	1 1/4 (32)																
Minimum axial spacing distance along flute (see detail in Figure 5A)	s_{min}	in. (mm)		6 3/4 (171)	6 3/4 (171)	9 3/4 (248)													8 1/4 (210)	12 (305)	9 3/8 (238)	14 1/4 (362)
Minimum member topping thickness (see detail in Figure 5B)	$h_{min,deck}$	in. (mm)		2 1/4 (57)	2 1/4 (57)																	
Minimum edge distance, lower flute (see detail in Figure 5B)	c_{min}	in. (mm)		3/4 (19)	3/4 (19)																	
Minimum axial spacing distance along flute (see detail in Figure 5B)	s_{min}	in. (mm)		6 (152)	6 (152)	9 3/4 (248)																

For SI: 1 inch = 25.4 mm, 1 ft-lbf = 1.356 N-m.

¹The information presented in this table is to be used in conjunction with the design criteria of ACI 318-19 Chapter 17.

²The listed minimum overall anchor length is based on anchor sizes commercially available at the time of publication compared with the requirements to achieve the minimum nominal embedment depth, nut height and washer thickness (and consideration of a possible fixture attachment, as applicable).

³The 1/4-inch and 3/8-inch-diameter anchors as well as the 1/2-inch-diameter anchors with 2 1/2 inch nominal embedment may be installed in the topside of uncracked concrete-filled steel deck assemblies where concrete thickness above the upper flute meets the minimum member thicknesses specified in this table. The 5/8-inch through 1 1/4-inch-diameter anchors may be installed in the topside of cracked and uncracked concrete-filled steel deck assemblies where concrete thickness above the upper flute meets the minimum member thicknesses specified in this table under Anchors Installed in Concrete.

⁴For installations in the topside of concrete-filled steel deck assemblies, see the installation detail in Figure 4.

⁵For installations through the soffit of steel deck assemblies into concrete, see the installation details in Figures 5A and 5B. In accordance with the figures, anchors must have an axial spacing along the flute equal to the greater of 3h_{ef} or 1.5 times the flute width.

⁶For installation of 5/8-inch-diameter anchors through the soffit of the steel deck into concrete, the installation torque is 50 ft.-lbf. For installation of 3/4-inch-diameter anchors through the soffit of the steel deck into concrete, installation torque is 80 ft.-lb

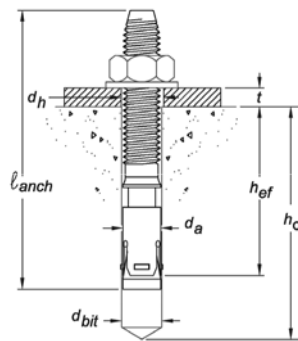
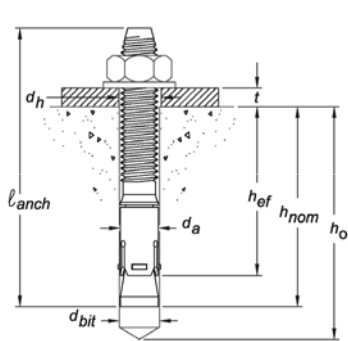

FIGURE 1—POWER-STUD+ SD1 ANCHOR DETAIL Before (Left Picture) and After (Right Picture) Application of Installation Torque

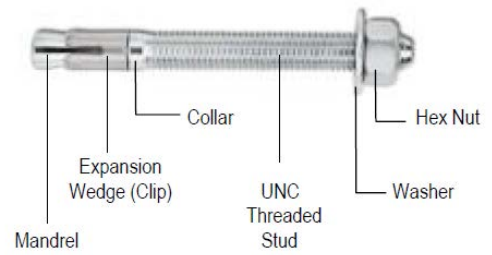
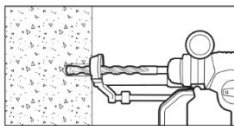
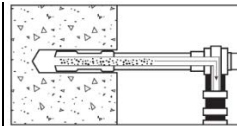

FIGURE 2—POWER-STUD+ SD1 ANCHOR ASSEMBLY



1.) Using the proper drill bit size, drill a hole into the base material to the required depth. The tolerances of the drill bit used should meet the requirements of ANSI Standard B2.12.15.



2.) Remove dust and debris from the hole during drilling (e.g. dust extractor, hollow bit) or following drilling (e.g. suction, forced air) to extract loose particles created by drilling.

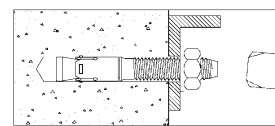



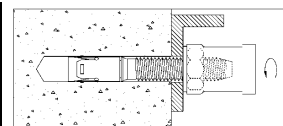













3.) Position the washer on the anchor and thread on the nut. If installing through a fixture, drive the anchor through the fixture into the hole. Be sure the anchor is driven to the minimum required embedment depth, h_{nom} .



4.) Tighten the anchor with a torque wrench by applying the required installation torque, T_{inst} . See Table 1. Note: The threaded stud draws up during the tightening of the nut; the expansion clip (wedge) remains in original position.

FIGURE 3—POWER-STUD+ SD1 INSTALLATION INSTRUCTIONS

DeWALT Dust Removal Drilling System with HEPA Dust Extractor Options		
Tool	Accessories and Shrouds	Dust Extractor
SDS-Max Drills		
 Cordless  Corded	 SDS-Max Hollow Drill Bits	 Dust Extractor
	 SDS-Max Drill Bits With Shroud	
SDS-Plus Drills		
 Cordless	 SDS-Plus Drill Bits	 Cordless On-board Dust Extractor
	 SDS-Plus Stop Drill Bits	
 Corded	 SDS-Plus Hollow Drill Bits	 Dust Extractor
	 SDS-Plus Drill Bits With Telescope	
	 SDS-Plus Drill Bits With Suction Tube	
	 SDS-Plus Drill Bits With Shroud	
	 SDS-Plus Stop Drill Bits With Shroud	

The DEWALT drilling systems shown collect and remove dust with a HEPA dust extractor during the hole drilling operation in dry base materials using hammer-drills (see manufacturer's printed installation instructions).

FIGURE A—EXAMPLES OF DEWALT DUST REMOVAL DRILLING SYSTEMS WITH HEPA DUST EXTRACTORS FOR ILLUSTRATION

TABLE A—POWER-STUD+ SD1 ANCHOR LENGTH CODE IDENTIFICATION SYSTEM

Length ID marking on threaded stud head		A	B	C	D	E	F	G	H	I	J	K	L	M	N	O	P	Q	R	S	T
		Overall anchor length, l_{anch} , (inches)	From	1 1/2	2	2 1/2	3	3 1/2	4	4 1/2	5	5 1/2	6	6 1/2	7	7 1/2	8	8 1/2	9	9 1/2	10
	Up to but not including	2	2 1/2	3	3 1/2	4	4 1/2	5	5 1/2	6	6 1/2	7	7 1/2	8	8 1/2	9	9 1/2	10	11	12	13

For SI: 1 inch = 25.4 mm.

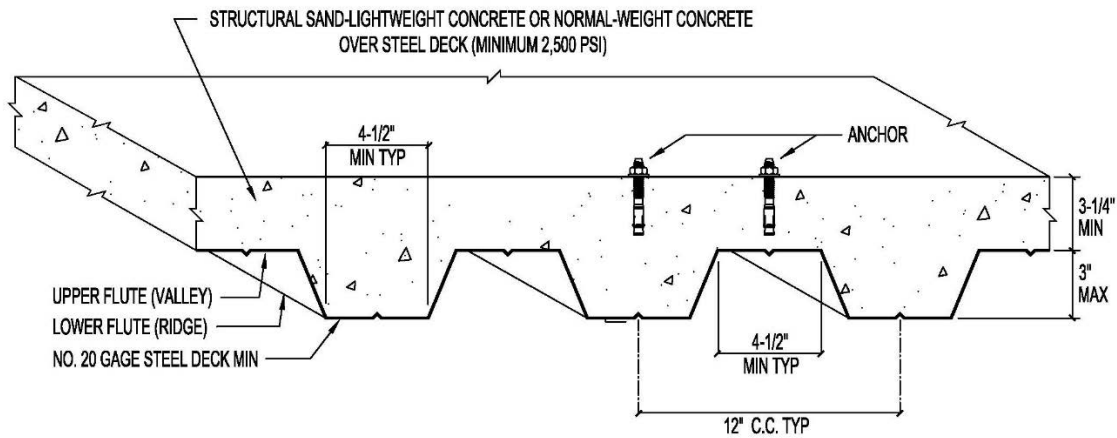

FIGURE 4—POWER-STUD+ SD1 INSTALLATION DETAIL FOR ANCHORS IN THE TOPSIDE OF CONCRETE-FILLED STEEL DECK FLOOR AND ROOF ASSEMBLIES (SEE DIMENSIONAL PROFILE REQUIREMENTS)¹

¹Anchors may be placed in the topside of steel deck profiles in accordance with Figure 4 provided the minimum member topping thickness, minimum spacing distance and minimum edge distance are satisfied as given in [Table 1](#) of this report.

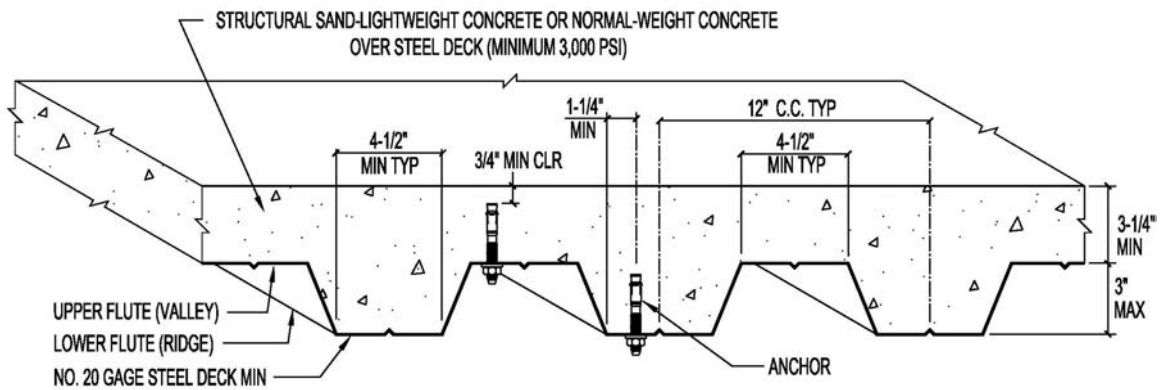

FIGURE 5A—POWER-STUD+ SD1 INSTALLATION DETAIL FOR ANCHORS IN THE SOFFIT OF CONCRETE OVER STEEL DECK FLOOR AND ROOF ASSEMBLIES (SEE DIMENSIONAL PROFILE REQUIREMENTS)¹

¹Anchors may be placed in the upper flute or lower flute of the steel deck profiles in accordance with Figure 5A provided the minimum hole clearance is satisfied. Anchors in the lower flute of Figure 5A profiles may be installed with a maximum 1-inch offset in either direction from the center of the flute. The offset distance may be increased proportionally for profiles with lower flute widths greater than those shown provided the minimum lower flute edge distance is also satisfied. In addition, the anchors must have an axial spacing along the flute equal to the greater of $3h_{ef}$ or 1.5 times the flute width.

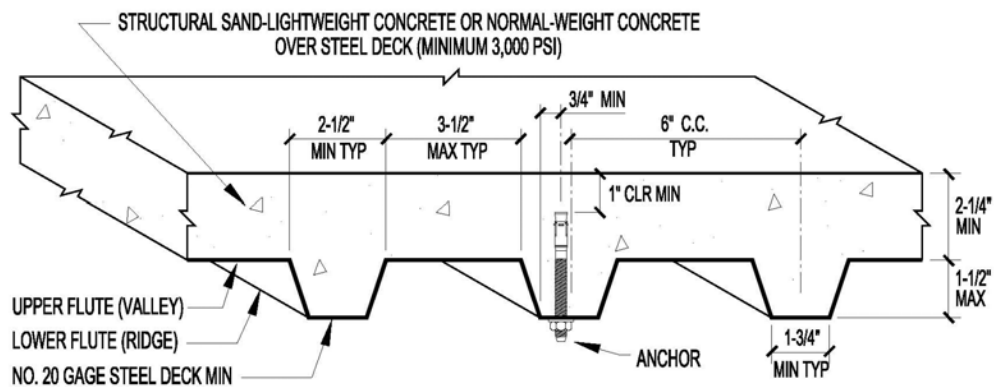

FIGURE 5B—POWER-STUD+ SD1 INSTALLATION DETAIL FOR ANCHORS IN THE SOFFIT OF CONCRETE OVER STEEL DECK FLOOR AND ROOF ASSEMBLIES (SEE DIMENSIONAL PROFILE REQUIREMENTS)^{1,2}

¹Anchors may be placed in the lower flute of the steel deck profiles in accordance with Figure 5B provided the minimum hole clearance is satisfied. Anchors in the lower flute of Figure 5B profiles may be installed with a maximum 1/8-inch offset in either direction from the center of the flute. The offset distance may be increased proportionally for profiles with lower flute widths greater than those shown provided the minimum lower flute edge distance is also satisfied. In addition, the anchors must have an axial spacing along the flute equal to the greater of $3h_{ef}$ or 1.5 times the flute width.

²Anchors may be placed in the upper flute of the steel deck profiles in accordance with Figure 5B provided the concrete thickness above the upper flute is minimum 3/4-inch and a minimum hole clearance of 3/4-inch is satisfied.

TABLE 2—TENSION DESIGN INFORMATION FOR POWER-STUD+ SD1 ANCHOR IN CONCRETE^{1,2}

Design Characteristic	Notation	Units	Nominal Anchor Diameter															
			1/4 inch	3/8 inch	1/2 inch	5/8 inch	3/4 inch	7/8 inch	1 inch	1 1/4 inch								
Anchor category	1, 2 or 3	-	1	1	1	1	1	1	1	1	1	1						
Effective embedment depth	h_{ef}	in. (mm)	1.50 (38)	2.00 (51)	2.00 (51)	3.25 (83)	2.75 (70)	4.00 (102)	3.125 (79)	4.75 (114)	3.50 (89)	4.375 (111)	5.375 (137)					
STEEL STRENGTH IN TENSION (ACI 318-19 Section 17.6.1)⁴																		
Minimum specified yield strength (neck)	f_{ya}	ksi (N/mm ²)	88.0 (606)	88.0 (606)	80.0 (551)	80.0 (551)	80.0 (551)	64.0 (441)	58.0 (400)	58.0 (400)	58.0 (400)	58.0 (400)						
Minimum specified ultimate tensile strength (neck)	f_{uta}	ksi (N/mm ²)	110.0 (758)	110.0 (758)	100.0 (689)	100.0 (689)	100.0 (689)	80.0 (552)	75.0 (517)	75.0 (517)	75.0 (517)	75.0 (517)						
Effective tensile stress area (neck)	$A_{se,N}$	in ² (mm ²)	0.0220 (14.2)	0.0531 (34.3)	0.1018 (65.7)	0.1626 (104.9)	0.2376 (150.9)	0.327 (207.5)	0.430 (273.1)	0.430 (273.1)	0.430 (273.1)	0.762 (484)						
Steel strength in tension ⁴	N_{sa}	lb (kN)	2,255 (10.0)	5,455 (24.3)	9,080 (40.4)	14,465 (64.3)	19,000 (84.5)	24,500 (109.0)	32,250 (143.5)	32,250 (143.5)	32,250 (143.5)	56,200 (250)						
Reduction factor for steel strength ³	ϕ	-	0.75															
CONCRETE BREAKOUT STRENGTH IN TENSION (ACI 318-19 Section 17.6.2)⁸																		
Effective embedment depth	h_{ef}	in. (mm)	1.50 (38)	2.00 (51)	2.00 (51)	3.25 (83)	2.75 (70)	4.00 (102)	3.125 (79)	4.75 (114)	3.50 (89)	4.375 (111)	5.375 (137)					
Effectiveness factor for uncracked concrete	k_{uncr}	-	24	24	24	24	24	24	24	24	24	24	27					
Effectiveness factor for cracked concrete	k_{cr}	-	Not Applicable	17	17	17	17	21	17	21	24	24	24					
Modification factor for cracked and uncracked concrete ⁵	$\psi_{c,N}$	-	1.0	1.0	1.0	1.0	1.0	1.0	1.0	1.0	1.0	1.0	1.0					
Critical edge distance (uncracked concrete only)	c_{ac}	in. (mm)	See Table 1															
Reduction factor for concrete breakout strength ³	ϕ	-	0.65 (Condition B)															
PULLOUT STRENGTH IN TENSION (ACI 318-19 Section 17.6.3)^{8,9}																		
Characteristic pullout strength, uncracked concrete (2,500 psi) ⁶	$N_{p,uncr}$	lb (kN)	See note 7	2,865 (12.8)	3,220 (14.3)	5,530 (24.6)	See note 7	See note 7	See note 7	See note 7	See note 7	See note 7	See note 7					
Characteristic pullout strength, cracked concrete (2,500 psi) ⁶	$N_{p,cr}$	lb (kN)	Not Applicable	2,035 (9.1)	See note 7	2,505 (11.2)	See note 7	4,450 (19.8)	See note 7	See note 7	See note 7	See note 7	11,350 (50.5)					
Reduction factor for pullout strength ³	ϕ	-	0.65 (Condition B)															
PULLOUT STRENGTH IN TENSION FOR SEISMIC APPLICATIONS (ACI 318-19 Section 17.10.3)^{8,9}																		
Characteristic pullout strength, seismic (2,500 psi) ^{6,10}	$N_{p,eq}$	lb (kN)	Not Applicable	2,035 (9.1)	See note 7	2,505 (11.1)	See note 7	4,450 (19.8)	See note 7	See note 7	See note 7	See note 7	11,350 (50.5)					
Reduction factor for pullout strength, seismic ³	ϕ	-	0.65 (Condition B)															
PULLOUT STRENGTH IN TENSION FOR ANCHORS INSTALLED THROUGH THE SOFFIT OF SAND-LIGHTWEIGHT AND NORMAL-WEIGHT CONCRETE OVER STEEL DECK																		
Figure 5A	Characteristic pullout strength, uncracked concrete over steel deck ^{6,11}	$N_{p,deck,uncr}$	lb (kN)	Not Applicable	1,940 (8.6)	3,205 (14.2)	2,795 (12.4)	3,230 (14.4)	Not Applicable	Not Applicable	Not Applicable	Not Applicable						
	Characteristic pullout strength, cracked concrete over steel deck ^{6,11}	$N_{p,deck,cr}$	lb (kN)		1,375 (6.1)	2,390 (10.6)	1,980 (8.8)	2,825 (12.4)										
	Characteristic pullout strength, cracked concrete over steel deck, seismic ^{6,11}	$N_{p,deck,eq}$	lb (kN)		1,375 (6.1)	2,390 (10.6)	1,980 (8.8)	2,825 (12.4)										
Figure 5B	Characteristic pullout strength, uncracked concrete over steel deck ^{6,11}	$N_{p,deck,uncr}$	lb (kN)		Not Applicable	1,665 (7.4)	1,900 (8.5)	Not Applicable					Not Applicable	Not Applicable	Not Applicable	Not Applicable		
	Characteristic pullout strength, cracked concrete over steel deck ^{6,11}	$N_{p,deck,cr}$	lb (kN)			1,180 (5.2)	1,420 (6.3)											
	Characteristic pullout strength, cracked concrete over steel deck, seismic ^{6,11}	$N_{p,deck,eq}$	lb (kN)			1,180 (5.2)	1,420 (6.3)											
Reduction factor for pullout strength, concrete over steel deck ³	ϕ	-	0.65 (Condition B)															

For SI: 1 inch = 25.4 mm; 1 ksi = 6.894 N/mm²; 1 lbf = 0.0044 kN.

¹The data in this table is intended to be used with the design provisions of ACI 318-19 Chapter 17; for anchors resisting seismic load combinations the additional requirements of ACI 318-19 Section 17.10 must apply.

²Installation must comply with printed instructions and details.

³The strength reduction factor applies when the load combinations from the 2024 IBC or ACI 318-19 are used and the requirements of ACI 318-19 Section 17.5.3 are met.

⁴The Power-Stud+ SD1 is considered a ductile steel element as defined by ACI 318-19 Section 2.3. Tabulated values for steel strength in tension are based on test results per ACI 355.2 and must be used for design.

⁵For all design cases use $\psi_{c,N} = 1.0$. The appropriate effectiveness factor for cracked concrete (k_{cr}) or uncracked concrete (k_{uncr}) must be used.

⁶For all design cases use $\psi_{c,N} = 1.0$. For the calculation of N_{pn} , including adjustment for the specified concrete compressive strength, see Section 4.1.4 of this report.

⁷Pullout strength does not control design of indicated anchors. Do not calculate pullout strength for indicated anchor size and embedment.

⁸Anchors are permitted to be used in lightweight concrete in accordance with Section 4.1.12 of this report.

⁹For anchors in the topside of concrete-filled steel deck assemblies, see [Figure 4](#).

¹⁰Tabulated values for characteristic pullout strength in tension are for seismic applications and based on test results in accordance with ACI 355.2, Section 9.5.

¹¹Values for $N_{p,deck}$ are for sand-lightweight concrete ($f'_{c,min} = 3,000$ psi) and additional lightweight concrete reduction factors need not be applied. In addition, evaluation for the concrete breakout capacity in accordance with ACI 318-14 Section 17.6.2 is not required for anchors installed in the deck soffit (flute).

TABLE 3—SHEAR DESIGN INFORMATION FOR POWER-STUD+ SD1 ANCHOR IN CONCRETE^{1,2}

Design Characteristic	Notation	Units	Nominal Anchor Diameter										
			1/4 inch	3/8 inch	1/2 inch	5/8 inch	3/4 inch	7/8 inch	1 inch	1 1/4 inch			
Anchor category	1, 2 or 3	-	1	1	1	1	1	1	1	1	1	1	
Effective embedment	h_{ef}	in. (mm)	1.50 (38)	2.00 (51)	2.00 (51)	3.25 (83)	2.75 (70)	4.00 (102)	3.125 (79)	4.75 (114)	3.50 (88.9)	4.375 (111)	5.375 (137)
STEEL STRENGTH IN SHEAR (ACI 318-19 Section 17.7.1)⁴													
Minimum specified yield strength (threads)	f_{ya}	ksi (N/mm ²)	70.4 (482)	80.0 (552)	70.4 (485)	70.4 (485)	64.0 (441)	58.0 (400)	58.0 (400)	58.0 (400)	58.0 (400)	58.0 (400)	58.0 (400)
Minimum specified ultimate strength (threads)	f_{uta}	ksi (N/mm ²)	88.0 (606)	100.0 (689)	88.0 (607)	88.0 (607)	80.0 (552)	75.0 (517)	75.0 (517)	75.0 (517)	75.0 (517)	75.0 (517)	75.0 (517)
Effective tensile stress area (threads)	$A_{sa,v}$	in ² (mm ²)	0.0318 (20.5)	0.0775 (50.0)	0.1419 (91.5)	0.2260 (145.8)	0.3345 (212.4)	0.462 (293.4)	0.606 (384.8)	0.606 (384.8)	0.969 (615)	0.969 (615)	0.969 (615)
Steel strength in shear ⁵	V_{sa}	lb (kN)	925 (4.1)	2,990 (13.3)	4,620 (20.6)	9,030 (40.2)	10,640 (47.3)	11,655 (54.8)	8,820 (39.2)	10,935 (48.6)	17,750 (79.0)	17,750 (79.0)	17,750 (79.0)
Reduction factor for steel strength in shear ³	ϕ	-	0.65										
STEEL STRENGTH IN SHEAR FOR SEISMIC APPLICATIONS (ACI 318-19 Section 17.10.3)													
Steel strength in shear, seismic ⁸	$V_{sa,eq}$	lb (kN)	Not Applicable	2,440 (10.9)	3,960 (17.6)	6,000 (26.7)	8,580 (38.2)	9,635 (42.9)	8,820 (39.2)	9,845 (43.8)	17,750 (79.0)	17,750 (79.0)	17,750 (79.0)
Reduction factor for steel strength in shear, seismic ³	ϕ	-	0.65										
CONCRETE BREAKOUT STRENGTH IN SHEAR (ACI 318-19 Section 17.7.2)^{6,7}													
Load bearing length of anchor	ℓ_e	in. (mm)	1.50 (38)	2.00 (51)	2.00 (51)	3.25 (83)	2.75 (70)	4.00 (102)	3.125 (79)	4.75 (114)	3.50 (88.9)	4.375 (111)	5.375 (137)
Nominal anchor diameter	d_a	in. (mm)	0.250 (6.4)	0.375 (9.5)	0.500 (12.7)	0.625 (15.9)	0.750 (19.1)	0.875 (22.2)	1.00 (25.4)	1.25 (31.8)	1.00 (25.4)	1.25 (31.8)	1.25 (31.8)
Reduction factor for concrete breakout ³	ϕ	-	0.70 (Condition B)										
PRYOUT STRENGTH IN SHEAR (ACI 318-19 Section 17.7.3)^{6,7}													
Coefficient for prout strength	k_{cp}	-	1.0	1.0	1.0	2.0	2.0	2.0	2.0	2.0	2.0	2.0	2.0
Reduction factor for prout strength ³	ϕ	-	0.70 (Condition B)										
STEEL STRENGTH IN SHEAR FOR ANCHORS INSTALLED THROUGH THE SOFFIT OF SAND-LIGHTWEIGHT AND NORMAL-WEIGHT CONCRETE OVER STEEL DECK^{9,10}													
Figure 5A	Steel strength in shear, concrete over steel deck ⁹	$V_{sa,deck}$	lb (kN)	Not Applicable	2,120 (9.4)	2,290 (10.2)	3,710 (16.5)	5,505 (24.5)	Not Applicable	Not Applicable	Not Applicable	Not Applicable	Not Applicable
	Steel strength in shear, concrete over steel deck, seismic ⁹	$V_{sa,deck,eq}$	lb (kN)		2,120 (9.4)	2,290 (10.2)	3,710 (16.5)	4,570 (20.3)					
Figure 5B	Steel strength in shear, concrete over steel deck ⁹	$V_{sa,deck}$	lb (kN)		2,120 (9.4)	2,785 (12.4)	Not Applicable	Not Applicable	Not Applicable	Not Applicable	Not Applicable	Not Applicable	Not Applicable
	Steel strength in shear, concrete over steel deck, seismic ⁹	$V_{sa,deck,eq}$	lb (kN)		2,120 (9.4)	2,785 (12.4)							
Reduction factor for steel strength in shear, concrete over steel deck ³			ϕ	-	0.65								

For **S1**: 1 inch = 25.4 mm; 1 ksi = 6.894 N/mm²; 1 lbf = 0.0044 kN.

¹The data in this table is intended to be used with the design provisions of ACI 318-19 Chapter 17; for anchors resisting seismic load combinations the additional requirements of ACI 318-19 Section 17.10 must apply.

²Installation must comply with printed instructions and details.

³The strength reduction factor applies when the load combinations from the 2024 IBC or ACI 318-19 are used and the requirements of ACI 318-19 Section 17.5.3 are met.

⁴The Power-Stud+ SD1 is considered a ductile steel element as defined by ACI 318-19 Section 2.3.

⁵Tabulated values for steel strength in shear must be used for design.

⁶Anchor are permitted to be used in lightweight concrete in accordance with Section 4.1.12 of this report.

⁷For anchors in the topside of concrete-filled steel deck assemblies, see [Figure 4](#).

⁸Tabulated values for steel strength in shear are for seismic applications and based on test results in accordance with ACI 355.2, Section 9.6.

⁹Tabulated values for $V_{sa,deck}$ and $V_{sa,deck,eq}$ are for sand-lightweight concrete ($f'_{c,min} = 3,000$ psi); additional lightweight concrete reduction factors need not be applied. In addition, evaluation for the concrete breakout capacity in accordance with ACI 318-19 Section 17.7.2 and the prout capacity in accordance with ACI 318-19 Section 17.7.3 are not required for anchors installed in the deck soffit (flute).

¹⁰Shear loads for anchors installed through steel deck into concrete may be applied in any direction.

TABLE 4—EXAMPLE ALLOWABLE STRESS DESIGN VALUES FOR ILLUSTRATIVE PURPOSES^{1,2,3,4,5,6,7,8,9}

Anchor Diameter (inches)	Nominal Embedment Depth (inches)	Effective Embedment (inches)	Allowable Tension Load (pounds)
1/4	1 3/4	1.50	970
3/8	2 3/8	2.00	1,260
1/2	2 1/2	2.00	1,415
	3 3/4	3.25	2,425
5/8	3 3/8	2.75	2,405
	4 5/8	4.00	4,215
3/4	4	3.125	2,910
	5 5/8	4.75	5,455
7/8	4 1/2	3.50	3,450
1	5 1/2	4.375	4,820
1 1/4	6 1/2	5.375	7,385

For SI: 1 inch = 25.4 mm, 1 lbf = 4.45 N.

¹Single anchor with static tension load only.

²Concrete determined to remain uncracked for the life of the anchorage.

³Load combinations are taken from ACI 318-19 Section 5.3 (no seismic loading).

⁴30% dead load and 70% live load, controlling load combination 1.2D + 1.6L.

⁵Calculation of weighted average for conversion factor $\alpha = 1.2(0.3) + 1.6(0.7) = 1.48$.

⁶ $f'_c = 2,500$ psi (normal weight concrete).

⁷ $C_{a1} = C_{a2} \geq C_{ac}$.

⁸ $h \geq h_{min}$.

⁹Values are for Condition B where supplementary reinforcement in accordance with ACI 318-19 Section 17.5.3 is not provided.

<p>Given: Calculate the factored resistance strength, ϕN_n, and the allowable stress design value, $T_{allowable, ASD}$, for a 3/8-inch-diameter Power-Stub+ SD1 anchor assuming the given conditions in Table 4.</p>		
<p>Calculation in accordance with ACI 318-19 and this report:</p>	ACI 318-19 Ref.	Report Ref.
<p>Step 1. Calculate steel strength of a single anchor in tension: $\phi N_{sa} = (0.75)(5,455) = 4,091 \text{ lbs.}$</p>	17.6.1.2	Table 2
<p>Step 2. Calculate concrete breakout strength of a single anchor in tension: $\phi N_{cb} = \phi \frac{A_{Nc}}{A_{Nc0}} \psi_{ed,N} \psi_{c,N} \psi_{cp,N} N_b$ $N_b = k_c \lambda_a \sqrt{f'_c} (h_{ef})^{1.5}$ $N_b = (24)(1.0) \sqrt{2,500} (2.0)^{1.5} = 3,394 \text{ lbs.}$ $\phi N_{cb} = (0.65) \frac{(36.0)}{(36.0)} (1.0)(1.0)(1.0)(3,394) = 2,206 \text{ lbs.}$</p>	17.6.2.1	Table 2
<p>Step 3. Calculate pullout strength of a single anchor: $\phi N_{pn} = \phi N_{p,uncr} \psi_{c,p} \left(\frac{f'_{c,act}}{2,500} \right)^n$ $\phi N_{pn} = (0.65)(2,865)(1.0)(1.0)^{0.5} = 1,862 \text{ lbs.}$</p>	17.6.3.2.1	Table 2
<p>Step 4. Determine controlling factored resistance strength in tension: $\phi N_n = \min[\phi N_{sa}, \phi N_{cb}, \phi N_{pn}] = \phi N_{pn} = 1,862 \text{ lbs.}$</p>	17.5.1.3	-
<p>Step 5. Calculate allowable stress design conversion factor for loading condition: Controlling load combination: 1.2D + 1.6L $\alpha = 1.2(30\%) + 1.6(70\%) = 1.48$</p>	5.3	-
<p>Step 6. Calculate the converted allowable stress design value: $T_{allowable, ASD} = \frac{\phi N_n}{\alpha} = \frac{1,862}{1.48} = 1,258 \text{ lbs.}$</p>	-	Section 4.2

FIGURE 6—EXAMPLE STRENGTH DESIGN CALCULATION INCLUDING ASD CONVERSION FOR ILLUSTRATIVE PURPOSES

TABLE 5— APPLICABLE SECTIONS OF THE IBC UNDER EACH EDITION OF THE IBC

2024 IBC	2021 IBC	2018 IBC	2015 IBC
Section 1605.1		Section 1605.2 or 1605.3	
Section 1705.1.1 and Table 1705.3			
Section 1901.3			
Sections 1903 and 1905			
Section 1905.7	Section 1905.1.8		

TABLE 6— APPLICABLE SECTIONS OF ACI 318 UNDER EACH EDITION OF THE IBC

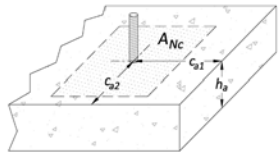
2024 IBC	2021 IBC	2018 IBC	2015 IBC
ACI 318-19		ACI 318-14	
2.3		2.3	
5.3		5.3	
Chapter 17		Chapter 17	
17.5.1.2		17.3.1	
17.5.1.3		17.3.1.1	
17.5.3		17.3.3	
17.6.1		17.4.1	
17.6.1.2		17.4.1.2	
17.6.2		17.4.2	
17.6.2.1		17.4.2.1	
17.6.2.2		17.4.2.2	
17.6.2.5.1(a)		17.4.2.6	
17.6.3		17.4.3	
17.6.3.1		17.4.3.1	
17.6.3.2.1		17.4.3.2	
17.6.3.3		17.4.3.6	
17.7.1		17.5.1	
17.7.1.2		17.5.1.2	
Eq. 17.7.1.2b		Eq. 17.5.1.2b	
17.7.2		17.5.2	
17.7.2.1		17.5.2.1	
17.7.2.2.1		17.5.2.2	
17.7.3		17.5.3	
17.8		17.6	
17.9.2		17.7.1 and 17.7.3	
17.9.4		17.7.5	
17.9.5		17.7.6	
17.10		17.2.3	
17.10.3		17.2.3.3	
17.10.4, 17.10.5, 17.10.6, 17.10.7		17.2.3.4, 17.2.3.5, 17.2.3.6, 17.2.3.7	

DIVISION: 03 00 00—CONCRETE
Section: 03 16 00—Concrete Anchors

DIVISION: 05 00 00—METALS
Section: 05 05 19—Post-Installed Concrete Anchors

REPORT HOLDER:

DEWALT

EVALUATION SUBJECT:**POWER-STUD®+ SD1 EXPANSION ANCHORS FOR CRACKED AND UNCRACKED CONCRETE (DEWALT)****1.0 REPORT PURPOSE AND SCOPE****Purpose:**

The purpose of this evaluation report supplement is to indicate that Power-Stud+ SD1 Expansion Anchors for cracked and uncracked concrete, described in ICC-ES evaluation report [ESR-2818](#), have also been evaluated for compliance with the codes noted below as adopted by the Los Angeles Department of Building and Safety (LADBS).

Applicable code editions:

- 2023 *City of Los Angeles Building Code* ([LABC](#))
- 2023 *City of Los Angeles Residential Code* ([LARC](#))

2.0 CONCLUSIONS

The Power-Stud+ SD1 Expansion Anchors for cracked and uncracked concrete, described in Sections 2.0 through 7.0 of the evaluation report [ESR-2818](#), comply with the LABC Chapter 19, and the LARC, and are subject to the conditions of use described in this supplement.

3.0 CONDITIONS OF USE

The Power-Stud+ SD1 Expansion Anchors for cracked and uncracked concrete described in this evaluation report supplement must comply with all of the following conditions:

- All applicable sections in the evaluation report [ESR-2818](#).
- The design, installation, conditions of use and identification of the anchors are in accordance with the 2021 *International Building Code*® (IBC) provisions noted in the evaluation report [ESR-2818](#).
- The design, installation and inspection are in accordance with additional requirements of LABC Chapters 16 and 17, as applicable.
- Under the LARC, an engineered design in accordance with LARC Section R301.1.3 must be submitted.
- The allowable and strength design values listed in the evaluation report and tables, are for the connection of the anchors to the concrete. The connection between the anchors and the connected members shall be checked for capacity (which may govern).
- For use in wall anchorage assemblies to flexible diaphragm applications, anchors shall be designed per the requirements of City of Los Angeles Information Bulletin P/BC 2023-071.

This supplement expires concurrently with the evaluation report, reissued December 2024 and revised April 2025.

DIVISION: 03 00 00—CONCRETE

Section: 03 16 00—Concrete Anchors

DIVISION: 05 00 00—METALS

Section: 05 05 19—Post-Installed Concrete Anchors

REPORT HOLDER:

DEWALT

EVALUATION SUBJECT:

POWER-STUD®+ SD1 EXPANSION ANCHORS FOR CRACKED AND UNCRACKED CONCRETE (DEWALT)

1.0 REPORT PURPOSE AND SCOPE

Purpose:

The purpose of this evaluation report supplement is to indicate that the Power-Stud+ SD1 Expansion Anchors in uncracked concrete only [$1/4$ inch (6.4 mm)] and in cracked and uncracked concrete [$3/8$ inch to $1 1/4$ inches (9.5 mm to 31.8 mm)], described in ICC-ES evaluation report ESR-2818, have also been evaluated for compliance with the codes noted below.

Applicable code editions:

- 2023 Florida Building Code—Building
- 2023 Florida Building Code—Residential

2.0 CONCLUSIONS

The Power-Stud+ SD1 Expansion Anchors in uncracked concrete only [$1/4$ inch (6.4 mm)] and in cracked and uncracked concrete [$3/8$ inch to $1 1/4$ inches (9.5 mm to 31.8 mm)], described in Sections 2.0 through 7.0 of the evaluation report ESR-2818, comply with the *Florida Building Code—Building* and the *Florida Building Code—Residential*. The design requirements must be in accordance with the *Florida Building Code—Building* or the *Florida Building Code—Residential*, as applicable. The installation noted in ICC-ES evaluation report ESR-2818 for the 2021 *International Building Code*® meet the requirements of the *Florida Building Code—Building* or the *Florida Building Code—Residential*.

Use of the Power-Stud+ SD1 Expansion Anchors in uncracked concrete only [$1/4$ inch (6.4 mm)] and in cracked and uncracked concrete [$3/8$ inch to $1 1/4$ inches (9.5 mm to 31.8 mm)] has also been found to be in compliance with the High-Velocity Hurricane Zone Provisions of the *Florida Building Code—Building* and the *Florida Building Code—Residential* with the following condition:

- a) For anchorage to wood members, the connection subject to uplift, must be designed for no less than 700 pounds (3114 N).

For products falling under Florida Rule 61G20-3, verification that the report holder's quality assurance program is audited by a quality-assurance entity approved by the Florida Building Commission for the type of inspections being conducted is the responsibility of an approved validation entity (or the code official when the report holder does not possess an approval by the Commission).

This supplement expires concurrently with the evaluation report, reissued December 2024 and revised April 2025.